

THE
STARFLEET REGISTRY



RESEARCHED AND COMPILED BY
JOHN W. BULLERWELL

Introduction

What you hold is perhaps the most comprehensive listing of the NCC- and NX-Federation Starfleet registration numbers ever created. Unfortunately, as comprehensive as it is, it is also confusing, error filled and riddled with mysteries.

These numbers are from the entirety of fandom *and* canon. If you're looking for a work of completely canon numbers and nothing else, this is not the document for you. Because the majority of these numbers come from fandom, there are a lot of discrepancies, and a lot of replication. There are numerous considerations I needed to make in compiling the list.

For instance, I worked under the assumption that a ship with a lettered suffix (for example NCC-1234-C) is carrying a registry 'tradition', like the *Enterprise*. Therefore, if fandom listed a NCC-XXX-A U.S.S. *No Name*, I assumed the was a NCC-XXX (no suffix) *No Name* as well. While this is indeed very unlikely, I included them for the sake of completeness, as the original originator likely intended.

Also, spellings in this document are intentional. If a ships name was *Merrimac*, I did not change it to *Merrimack*, or vice-versa. Again, it is assumed that the originator of the ship's name/number intended their spelling to be correct.

Some vessels had the same names and numbers, but were listed under two different class names. An example of this would be the Orka-class and the Clarke-class. Both classes had the same ships and numbers. I simply chose which class appeared in fandom first if I could determine it.

Along these same lines, sometimes fandom has several different classes with the same names, often hundreds or thousands of numbers apart. I list both.

A great number of registry numbers have several starships listed. I offer no explanation for this in the document, but one might assume that Starfleet did a lot of jostling with the numbers. In the case of duplicate ships with the same numbers, canon vessels are listed first.

This work is a labour of love. But of course, I may have missed some numbers, and if so, I would ask that you contact me with corrections/additions at john.bullerwell@gmail.com.

NCC-01	U.S.S. <i>Dauntless</i>	Conqueror-class
	The first starship registered under the auspices of the Federation Starfleet.	
NCC-02	U.S.S. <i>Victory</i>	Conqueror-class.
NCC-03	U.S.S. <i>Hercules</i>	Conqueror-class
NCC-04	U.S.S. <i>Protector</i>	Conqueror-class
NCC-05	U.S.S. <i>Crusader</i>	Conqueror-class
NCC-06	U.S.S. <i>Yamato</i>	Yorktown-class
	Designated a carrier.	
NCC-07	U.S.S. <i>Valley Forge</i>	Yorktown-class
NCC-08	U.S.S. <i>Akagi</i>	Yorktown-class
	U.S.S. <i>Benjamin Franklin</i>	Clarke-class
	Decommissioned in 2280, the <i>Franklin</i> was purchased by a private group of investors in 2283 and refitted into a medical-services vessel and renamed the <i>S.S.Salutaris</i> .	
NCC-09	U.S.S. <i>Hood</i>	Yorktown-class
NCC-010	U.S.S. <i>Potemkin</i>	Yorktown-class
NCC-011	U.S.S. <i>Repulse</i>	Yorktown-class
NCC-012	U.S.S. <i>Rabin</i>	Yorktown-class
NCC-013	U.S.S. <i>Curran</i>	Curran-class
	First starship of her class, designated a patrol vessel.	
	U.S.S. <i>Benjamin Franklin</i>	Daedalus-class
	Launched Feb.13, 2179 under the command of Captain Iwasaki Ikushima (b.2146). The ship remained in service for over 175 years as an Academy training vessel. The vessel's motto was " <i>Outstanding</i> ".	
NCC-014	U.S.S. <i>Stiles</i>	Curran-class
NCC-015	U.S.S. <i>Thayer</i>	Curran-class
NCC-016	U.S.S. <i>Sudler</i>	Curran-class
NCC-017	U.S.S. <i>Crusher</i>	Curran-class
NCC-018	U.S.S. <i>Healy</i>	Curran-class
NCC-019	U.S.S. <i>Gauthier</i>	Curran-class
NCC-020	U.S.S. <i>Langer</i>	Curran-class
NCC-021	U.S.S. <i>Hotmer</i>	Curran-class
NCC-022	U.S.S. <i>Perri</i>	Curran-class
NCC-023	U.S.S. <i>Sullivan</i>	Curran-class
NCC-024	U.S.S. <i>Peterson</i>	Curran-class
NCC-025	U.S.S. <i>Leonardo</i>	Leonardo-class
	Prototype vessel of her class, designated as a corsair.	
	U.S.S. <i>Kolya</i>	Curran-class
NCC-026	U.S.S. <i>Stephenson</i>	Curran-class
NCC-027	U.S.S. <i>Russell</i>	Curran-class
NCC-028	U.S.S. <i>Conway</i>	Curran-class
	U.S.S. <i>San Francisco</i>	
NCC-029	U.S.S. <i>Schaefer</i>	Curran-class
	U.S.S. <i>Independence</i>	
NCC-030	U.S.S. <i>Potemkin</i>	
NCC-051	U.S.S. <i>Hood</i>	
NCC-054	U.S.S. <i>Endeavor</i>	
NCC-059	U.S.S. <i>Mars</i>	

NCC-061	U.S.S. <i>Intrepid</i>	
NCC-062	U.S.S. <i>London</i>	
NCC-067	U.S.S. <i>Chesapeake</i>	Powhatan-class
NCC-068	U.S.S. <i>Vandalia</i>	Powhatan-class
NCC-069	U.S.S. <i>Catskill</i>	Powhatan-class
NCC-070	U.S.S. <i>Canopus</i>	Canopus-class

First starship of her class, a science/survey vessel.

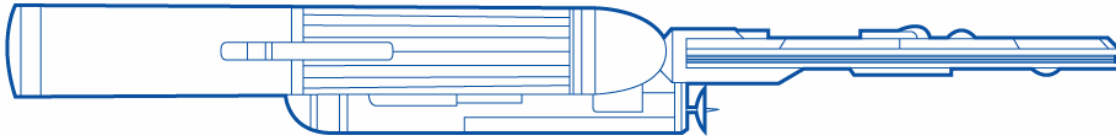

	U.S.S. <i>Hampton Roads</i>	Powhatan-class
NCC-071	U.S.S. <i>Albemarle</i>	Powhatan-class
NCC-072	U.S.S. <i>Corinth</i>	Powhatan-class
NCC-073	U.S.S. <i>Robert E. Lee</i>	Powhatan-class
NCC-074	U.S.S. <i>Massachusetts</i>	Powhatan-class
NCC-075	U.S.S. <i>Tennessee</i>	Powhatan-class
NCC-076	U.S.S. <i>Florida</i>	Powhatan-class
NCC-077	U.S.S. <i>Minnesota</i>	Powhatan-class
NCC-078	U.S.S. <i>Delaware</i>	Powhatan-class
NCC-079	U.S.S. <i>Atlanta</i>	Powhatan-class
NCC-080	U.S.S. <i>du Pont</i>	Powhatan-class
NCC-081	U.S.S. <i>Appomattox</i>	Powhatan-class
NCC-090	U.S.S. <i>Eagle</i>	
NCC-092	U.S.S. <i>Lexington</i>	
NCC-100	U.S.S. <i>Orka</i>	Orka-class

First vessel of her class, designated a gunboat by Starfleet.

U.S.S. *Clarke* Clarke-class

First ship of her class, a diplomatic clipper. Crewed by 61 persons, it was 115, long, 103m wide and 28.5m high. The ship was armed with three phaser banks and it weighed 31,000 metric tones.

NCC-101	U.S.S. <i>Abel</i>	Orka-class
NCC-102	U.S.S. <i>Pachelli</i>	Orka-class
	U.S.S. <i>Sirius</i>	
NCC-103	U.S.S. <i>Gutierrez</i>	Orka-class
NCC-104	U.S.S. <i>Baxman</i>	Orka-class
NCC-105	U.S.S. <i>Glumpler</i>	Orka-class
NCC-106	U.S.S. <i>Hamblin</i>	Orka-class
NCC-107	U.S.S. <i>O'Conner</i>	Orka-class
NCC-108	U.S.S. <i>Boyce</i>	Orka-class
NCC-109	U.S.S. <i>Nunnley</i>	Orka-class
	U.S.S. <i>Carthage</i>	
NCC-110	U.S.S. <i>Hollida</i>	Orka-class
NCC-111	U.S.S. <i>Goebel</i>	Orka-class

NCC-112	U.S.S. <i>Bostick</i>	Orka-class
NCC-113	U.S.S. <i>Owens</i>	Orka-class
NCC-114	U.S.S. <i>Garrison</i>	Orka-class
NCC-115	U.S.S. <i>Peevey</i>	Orka-class
NCC-116	U.S.S. <i>Oakes</i>	Orka-class
NCC-117	U.S.S. <i>Gallington</i>	Orka-class
NCC-118	U.S.S. <i>Chambers</i>	Orka-class
NCC-119	U.S.S. <i>Norton</i>	Orka-class
NCC-120	U.S.S. <i>Branch</i>	Orka-class
NCC-121	U.S.S. <i>Puente</i>	Orka-class
NCC-122	U.S.S. <i>Gonzalez</i>	Orka-class
	U.S.S. <i>Nebula</i>	
NCC-123	U.S.S. <i>Neel</i>	Orka-class
NCC-124	U.S.S. <i>Furrman</i>	Orka-class
NCC-125	U.S.S. <i>Charlton</i>	Orka-class
NCC-126	U.S.S. <i>Zuniga</i>	Orka-class
NCC-127	U.S.S. <i>Quenel</i>	Orka-class
NCC-128	U.S.S. <i>Fincher</i>	Orka-class
NCC-129	U.S.S. <i>McClead</i>	Orka-class
NCC-130	U.S.S. <i>Zhao</i>	Orka-class
NCC-131	U.S.S. <i>Herberger</i>	Orka-class
NCC-132	U.S.S. <i>Chumley</i>	Orka-class
NCC-133	U.S.S. <i>Qulliam</i>	Orka-class
NCC-134	U.S.S. <i>Fairchild</i>	Orka-class
NCC-135	U.S.S. <i>Zeissel</i>	Orka-class
NCC-136	U.S.S. <i>Eubank</i>	Orka-class
NCC-137	U.S.S. <i>Artemis</i>	Odysseus-class
	U.S.S. <i>Maynes</i>	Orka-class
NCC-138	U.S.S. <i>Rabum</i>	Orka-class
NCC-139	U.S.S. <i>Coakley</i>	Orka-class
NCC-140	U.S.S. <i>Hermanos</i>	Orka-class
NCC-141	U.S.S. <i>Yowel</i>	Orka-class
NCC-142	U.S.S. <i>Rodgers</i>	Orka-class
NCC-143	U.S.S. <i>Dolberry</i>	Orka-class
NCC-144	U.S.S. <i>Yildiz</i>	Orka-class
NCC-145	U.S.S. <i>Mastrovich</i>	Orka-class
NCC-146	U.S.S. <i>Dabbs</i>	Orka-class
NCC-147	U.S.S. <i>Rushing</i>	Orka-class
NCC-148	U.S.S. <i>Dunnigan</i>	Orka-class
NCC-149	U.S.S. <i>Isenberg</i>	Orka-class

NCC-150

U.S.S. *Daedalus*

Daedalus-class

First vessel of the Daedalus class, a cruiser that was one of Starfleet's most successful early designs. 105m long, 48m wide and 31m high, it had a crew compliment of 101.

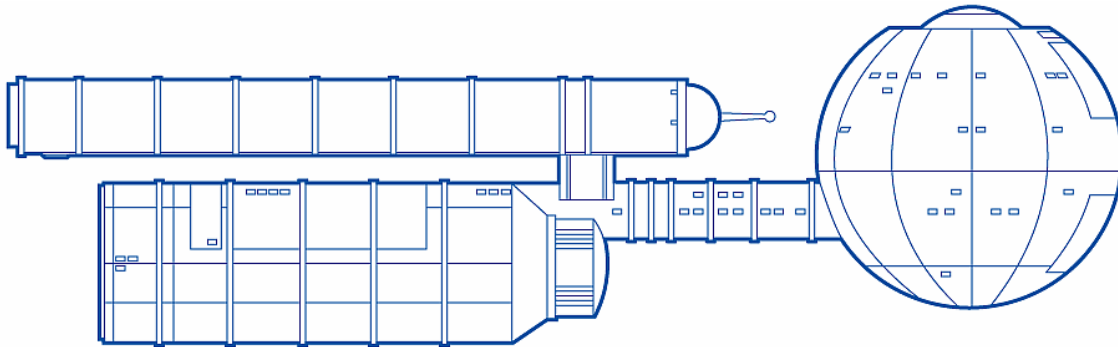

NCC-151

U.S.S. *Okinawa*

Okinawa-class

First vessel of the class.

U.S.S. *Whalin*

Orka-class

U.S.S. *Icarus*

Daedalus-class

U.S.S. *Sandeuffer*

Orka-class

NCC-152

U.S.S. *Phoenix*

Daedalus-class

U.S.S. *Lysaght*

Orka-class

NCC-153

U.S.S. *Valiant*

Daedalus-class

U.S.S. *Dyer*

Orka-class

NCC-154

U.S.S. *Clarke*

Daedalus-class

U.S.S. *Wallosch*

Orka-class

NCC-155

U.S.S. *Dakota*

Daedalus-class

U.S.S. *Shafferman*

Orka-class

NCC-156

U.S.S. *Proteus*

Daedalus-class

U.S.S. *Eckhardt*

Orka-class

NCC-157

U.S.S. *Voyager*

Daedalus-class

U.S.S. *Isom*

Orka-class

NCC-158

U.S.S. *Saladin*

Daedalus-class

U.S.S. *Huestises*

Orka-class

NCC-159

U.S.S. *Diana*

Daedalus-class

U.S.S. *Wilowiak*

Orka-class

NCC-160

U.S.S. *Carolina*

Daedalus-class

The *Carolina* had been welded to an asteroid in the Xii system and used as a habitat module for colonists, was returned to its original configuration and is now on display in the Starfleet Museum.

U.S.S. *Luna*

Orka-class

NCC-161

U.S.S. *Soyuz*

Daedalus-class

U.S.S. *Stevick*

Orka-class

NCC-162

U.S.S. *Apollo*

Daedalus-class

U.S.S. *Indicott*

Orka-class

NCC-163	U.S.S. <i>Pioneer</i>	Daedalus-class
	U.S.S. <i>Louisiana</i>	Daedalus-class
	U.S.S. <i>Iwanaka</i>	Orka-class
NCC-164	U.S.S. <i>Torvaldsen</i>	Daedalus-class
	U.S.S. <i>Vinton</i>	Orka-class
NCC-165	U.S.S. <i>Sputnik</i>	Daedalus-class
	U.S.S. <i>Jergens</i>	Orka-class
NCC-166	U.S.S. <i>Jefferson</i>	Daedalus-class
	U.S.S. <i>Luedecke</i>	Orka-class
NCC-167	U.S.S. <i>Nimrod</i>	Daedalus-class
	Starship destroyed in the early days of the Federation Starfleet.	
	U.S.S. <i>Tokyo</i>	Daedalus-class
	U.S.S. <i>Sommerville</i>	Orka-class
NCC-168	U.S.S. <i>Arronax</i>	Daedalus-class
	U.S.S. <i>Jacques</i>	Orka-class gunboat
NCC-169	U.S.S. <i>Mir</i>	Daedalus-class
	U.S.S. <i>Lieker</i>	Orka-class
NCC-170	U.S.S. <i>Hife</i>	Daedalus-class
	Starship that , when retired from active duty, became part of the Smithsonian Institute.	
	U.S.S. <i>Bowman</i>	Daedalus-class
	U.S.S. <i>Vardimann</i>	Orka-class
NCC-171	U.S.S. <i>Theodore Roosevelt</i>	Daedalus-class
	U.S.S. <i>Javier</i>	Orka-class
NCC-172	U.S.S. <i>Dolphin</i>	Daedalus-class
	U.S.S. <i>Coventry</i>	Daedalus-class
	U.S.S. <i>Krishinakuamar</i>	Orka-class
NCC-173	U.S.S. <i>Essex</i>	Daedalus-class
	Lost at a Class-M moon of planet Mab-Bu VI in 2167 while under the command of Captain Bryce Shumar. It had a crew of 229.	
	U.S.S. <i>Sultan</i>	Orka-class
NCC-174	U.S.S. <i>Robinson</i>	Daedalus-class
	U.S.S. <i>Moscow</i>	Daedalus-class
	U.S.S. <i>Vallejo</i>	Orka-class
NCC-175	U.S.S. <i>Frontier</i>	Daedalus-class
	U.S.S. <i>Lanning</i>	Orka-class
NCC-176	U.S.S. <i>Horizon</i>	Daedalus-class
	Destroyed shortly after visiting planet Sigma Iotia I in 2168.	
	U.S.S. <i>Jaushlin</i>	Orka-class
NCC-177	U.S.S. <i>Liberty</i>	Daedalus-class
	U.S.S. <i>Barron</i>	Daedalus-class
	U.S.S. <i>Uzzle</i>	Orka-class
NCC-178	U.S.S. <i>Asimov</i>	Daedalus-class
	U.S.S. <i>Mercury</i>	Daedalus-class
	U.S.S. <i>Thelen</i>	Orka-class

NCC-179	U.S.S. <i>Zond</i>	Daedalus-class
	U.S.S. <i>Andromeda</i>	Daedalus-class
	U.S.S. <i>Koloskie</i>	Orka-class
NCC-180	U.S.S. <i>Marco Polo</i>	Daedalus-class
	U.S.S. <i>Melbourne</i>	Daedalus-class
	U.S.S. <i>Johsen</i>	Orka-class
NCC-181	U.S.S. <i>Spaulding</i>	Daedalus-class
	U.S.S. <i>Kawasky</i>	Daedalus-class
	U.S.S. <i>Urbanosky</i>	Orka-class
NCC-182	U.S.S. <i>Lincoln</i>	Daedalus-class
	U.S.S. <i>Larson</i>	Daedalus-class
	U.S.S. <i>Timmons</i>	Orka-class
NCC-183	U.S.S. <i>Maury</i>	Daedalus-class
	U.S.S. <i>Gemini</i>	Daedalus-class
	U.S.S. <i>Jelinik</i>	Orka-class
NCC-184.	U.S.S. <i>Viking</i>	Daedalus-class
	U.S.S. <i>Sheffield</i>	Daedalus-class
	U.S.S. <i>Underhill</i>	Orka-class
NCC-185	U.S.S. <i>Johnson</i>	Daedalus-class
	U.S.S. <i>Lorenz</i>	Daedalus-class
NCC-186	U.S.S. <i>Shenandoah</i>	Daedalus-class
	U.S.S. <i>Wells</i>	Daedalus-class
NCC-187	U.S.S. <i>Nelson</i>	Daedalus-class
	U.S.S. <i>Bandi</i>	Daedalus-class
NCC-188	U.S.S. <i>Independence</i>	Daedalus-class
	U.S.S. <i>McGraw</i>	Daedalus-class
NCC-189	U.S.S. <i>Archon</i>	Daedalus-class
	Disappeared at planet Beta II in 2167.	
NCC-190	U.S.S. <i>Columbia</i>	Daedalus-class
NCC-191	U.S.S. <i>Challenger</i>	Daedalus-class
NCC-192	U.S.S. <i>Discovery</i>	Daedalus-class
NCC-193	U.S.S. <i>Atlantis</i>	Daedalus-class
NCC-194	U.S.S. <i>Endeavour</i>	Daedalus-class
NCC-195	U.S.S. <i>Hera</i>	Perseus-class
	One of Starfleet's first destroyers.	
	U.S.S. <i>Gaines</i>	Daedalus-class
NCC-196	U.S.S. <i>Venera</i>	Daedalus-class
NCC-197	U.S.S. <i>Buena Vista</i>	Daedalus-class
NCC-198	U.S.S. <i>Cassini</i>	Daedalus-class
	U.S.S. <i>Hercules</i>	
NCC-199	U.S.S. <i>Cochrane</i>	Daedalus-class
	U.S.S. <i>New York</i>	

NCC-200

U.S.S. *Asmodeus*

Asmodeus-class

First vessel and prototype of the Asmodeus class of corvette-type vessels. Well armed for its size with three dual phaser banks and 4 torpedo tubes, the small ship had a deadweight tonnage of 24,500 metric tones. It was crewed by 86 people, consisting of 16 officers and 70 crew. It was 102m long, 103m wide and 33m high.

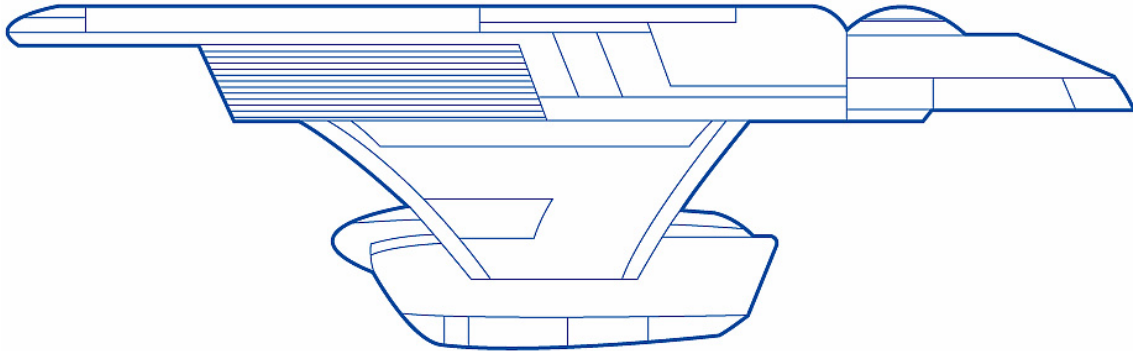

U.S.S. *Jester*

Jester-class

First vessel of the Jester class, classified as a corvette.

U.S.S. *Comet*

Comet-class cruiser.

First vessel and namesake of the Comet class cruiser.

NCC-201

U.S.S. *Icarus*

Icarus-class

The first starship of her class, designated an exploratory cruiser.

U.S.S. *Gailey*

Jester-class

U.S.S. *Meteor*

Comet-class

NCC-202

U.S.S. *Eagan*

Jester-class

U.S.S. *Aurora*

Comet-class

NCC-203

U.S.S. *Cox*

Jester-class

U.S.S. *Nova*

Comet-class

NCC-204

U.S.S. *McCready*

Jester-class

U.S.S. *Pulsar*

Comet-class

NCC-205

U.S.S. *Rosenburg*

Jester-class

U.S.S. *Nebula*

Comet-class

NCC-206

U.S.S. *Ariadne*

Ariadne-class

First vessel of her class, a clipper launched in 2277.

U.S.S. *Pfenning*

Jester-class

U.S.S. *Quasar*

Comet-class

NCC-207

U.S.S. *Tisdale*

Jester-class

U.S.S. *Eclipse*

Comet-class

NCC-208

U.S.S. *Underdog*

Jester-class

U.S.S. *Equinox*

Comet-class

NCC-209

U.S.S. *Eatherly*

Jester-class

U.S.S. *Solstice*

Comet-class

NCC-210

U.S.S. *Nikula*

Jester-class

U.S.S. *Corona*

Comet-class

NCC-211

U.S.S. *Lucio*

Jester-class

U.S.S. *Constellation*

Comet-class

NCC-212	U.S.S. <i>Polomsky</i>	Jester-class
	U.S.S. <i>Galaxy</i>	Comet-class
NCC-213	U.S.S. <i>Covington</i>	Jester-class
	U.S.S. <i>Flare</i>	Comet-class
NCC-214	U.S.S. <i>Turnpin</i>	Jester-class
	U.S.S. <i>Proxima</i>	Comet-class
NCC-215	U.S.S. <i>Saltamachio</i>	Jester-class
	U.S.S. <i>Polaris</i>	Comet-class
NCC-216	U.S.S. <i>Gallegos</i>	Jester-class
	U.S.S. <i>Mercury</i>	Comet-class
NCC-217	U.S.S. <i>Morganti</i>	Jester-class
	U.S.S. <i>Venus</i>	Comet-class
NCC-218	U.S.S. <i>Dykstra</i>	Jester-class
	U.S.S. <i>Luna</i>	Comet-class
NCC-219	U.S.S. <i>Angel Rubio</i>	Jester-class
	U.S.S. <i>Saturn</i>	Comet-class
NCC-220	U.S.S. <i>Lundberg</i>	Jester-class
	U.S.S. <i>Uranus</i>	Comet-class
NCC-221	U.S.S. <i>Etgen</i>	Jester-class
	U.S.S. <i>Neptune</i>	Comet-class
NCC-222	U.S.S. <i>Tongate</i>	Jester-class
	U.S.S. <i>Pluto</i>	Comet-class
NCC-223	U.S.S. <i>McIntyre</i>	Jester-class
	U.S.S. <i>Wasp</i>	Wasp-class

First vessel of her class, the *Wasp* was classified as a cruiser. 128m long, 66m wide and 62m high, the ship had a crew compliment of 150.

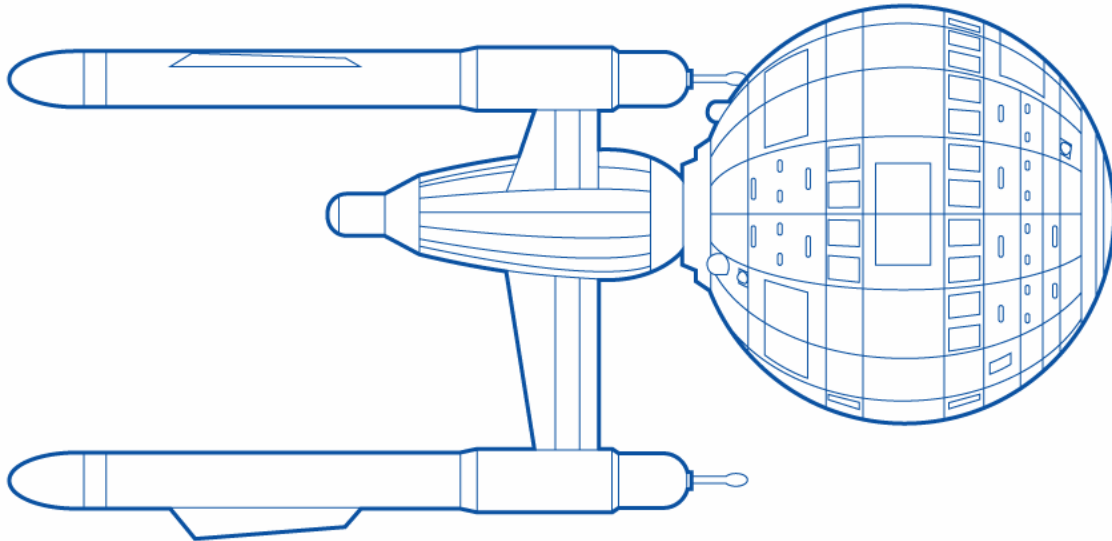

NCC-224	U.S.S. <i>Quintanna</i>	Jester-class
	U.S.S. <i>Decatur</i>	Wasp-class
	Ship lost and presumed destroyed.	
NCC-225	U.S.S. <i>Narayan</i>	Jester-class
	U.S.S. <i>Ranger</i>	Wasp-class

NCC-226	U.S.S. <i>Coykendall</i>	Jester-class
	U.S.S. <i>Kearsarge</i>	Wasp-class
	After being decommissioned in 2217, the <i>Kearsarge</i> was restored to her original three-nacelle configuration and is now on display at the Starfleet Museum.	
NCC-227	U.S.S. <i>Gerstner</i>	Jester-class
	U.S.S. <i>Jupiter</i>	Wasp-class
NCC-228	U.S.S. <i>Pappas</i>	Jester-class
	U.S.S. <i>Ericsson</i>	Wasp-class
NCC-229	U.S.S. <i>Vasquez</i>	Jester-class
	U.S.S. <i>Cumberland</i>	Wasp-class
NCC-230	U.S.S. <i>Lynch</i>	Jester-class
	U.S.S. <i>Mars</i>	Wasp-class
	Ship lost and presumed destroyed.	
NCC-231	U.S.S. <i>Erhart</i>	Jester-class
	U.S.S. <i>Holland</i>	Wasp-class
	Ship lost and presumed destroyed.	
NCC-232	U.S.S. <i>Wretch</i>	Jester-class
	U.S.S. <i>Bushnell</i>	Wasp-class
NCC-233	U.S.S. <i>Repstine</i>	Jester-class
	U.S.S. <i>Armstrong</i>	Wasp-class
NCC-234	U.S.S. <i>Otto</i>	Jester-class
	U.S.S. <i>Hunley</i>	Wasp-class
NCC-235	U.S.S. <i>Dunn</i>	Jester-class
	U.S.S. <i>Valiant</i>	Daedalus-class
	U.S.S. <i>Tang</i>	Wasp-class
	Ship lost and presumed destroyed.	
NCC-236	U.S.S. <i>Noriega</i>	Jester-class
	U.S.S. <i>Nautilus</i>	Wasp-class
NCC-237	U.S.S. <i>Morse</i>	Jester-class
	U.S.S. <i>Nelson</i>	Wasp-class
NCC-238	U.S.S. <i>Patton</i>	Hercules-class
	A destroyer.	
	U.S.S. <i>Luminarria</i>	Jester-class
	U.S.S. <i>Hercules</i>	
NCC-239	U.S.S. <i>Vejar</i>	Jester-class
	U.S.S. <i>New York</i>	
NCC-240	U.S.S. <i>Pantel</i>	Jester-class
	U.S.S. <i>Anaconda</i>	
NCC-241	U.S.S. <i>Torgerson</i>	Jester-class
	U.S.S. <i>Neptune</i>	
NCC-242	U.S.S. <i>Exum</i>	Jester-class
	U.S.S. <i>Olympia</i>	
NCC-243	U.S.S. <i>Pycior</i>	Jester-class
	U.S.S. <i>Tereshkova</i>	Armstrong-class
	Lost in 2203 while exploring the Kellinan Reach.	
	U.S.S. <i>Sydney</i>	
NCC-244	U.S.S. <i>Kennon</i>	Jester-class
	U.S.S. <i>Cassiopeia</i>	

NCC-245	U.S.S. <i>Berlingeri</i> U.S.S. <i>São Paulo</i>	Jester-class
NCC-246	U.S.S. <i>Ullrich</i> U.S.S. <i>Aquarius</i>	Jester-class
NCC-247	U.S.S. <i>Dupree</i>	Jester-class
NCC-248	U.S.S. <i>Lundquist</i>	Jester-class
NCC-249	U.S.S. <i>McVay</i>	Jester-class
NCC-250	U.S.S. <i>Roque</i>	Jester-class
NCC-251	U.S.S. <i>Bakdash</i> U.S.S. <i>Heron Bay</i>	Jester-class Durance-class
NCC-252	U.S.S. <i>Tinsley</i>	Jester-class
NCC-253	U.S.S. <i>Demarest</i> U.S.S. <i>Fireball</i>	Jester-class Fireball-class
	The first vessel of her class, designated as a light cruiser.	
NCC-254	U.S.S. <i>Ricosta</i> U.S.S. <i>Rocket</i>	Jester-class Fireball-class
NCC-255	U.S.S. <i>Morado</i>	Jester-class
NCC-256	U.S.S. <i>Evilsizer</i>	Jester-class
NCC-257	U.S.S. <i>Nolte</i>	Jester-class
NCC-258	U.S.S. <i>Craddock</i>	Jester-class
NCC-259	U.S.S. <i>Trantham</i>	Jester-class
NCC-260	U.S.S. <i>Foust</i>	Jester-class
NCC-261	U.S.S. <i>Looney</i> U.S.S. <i>Halsey</i>	Jester-class Durnace-class
NCC-262	U.S.S. <i>Picon</i>	Jester-class
NCC-263	U.S.S. <i>Loveless</i>	Jester-class
NCC-264	U.S.S. <i>Fuqua</i>	Jester-class
NCC-265	U.S.S. <i>Le'Clear</i>	Jester-class
NCC-266	U.S.S. <i>Garibay</i>	Jester-class
NCC-267	U.S.S. <i>Zavisca</i>	Jester-class
NCC-268	U.S.S. <i>York</i>	Jester-class
NCC-269	U.S.S. <i>Milligan</i>	Jester-class
NCC-270	U.S.S. <i>Cerda</i>	Jester-class
NCC-271	U.S.S. <i>Mermea</i>	Jester-class
NCC-272	U.S.S. <i>Dellinger</i>	Jester-class
NCC-273	U.S.S. <i>Tinker</i>	Jester-class
NCC-274	U.S.S. <i>Glasner</i>	Jester-class
NCC-275	U.S.S. <i>Nader Covair</i>	Jester-class
NCC-276	U.S.S. <i>Estes</i>	Jester-class
NCC-277	U.S.S. <i>Zeigler</i>	Jester-class
NCC-278	U.S.S. <i>Akula</i> U.S.S. <i>Requat</i>	Jester-class
NCC-278-A	U.S.S. <i>Akula</i>	Akula-class
	First vessel of her class, and at least the second vessel to bear the name.	
NCC-279	U.S.S. <i>Pharis</i>	Jester-class

NCC-280	U.S.S. <i>Nodurft</i> U.S.S. <i>Istanbul</i>	Jester-class
NCC-281	U.S.S. <i>Rocha</i>	Jester-class
NCC-287	U.S.S. <i>Cassiopeia</i>	
NCC-290	U.S.S. <i>Sao Paulo</i>	
NCC-299	U.S.S. <i>Ishtar Terra</i>	Olympus Mons-class
NCC-300	U.S.S. <i>Ra Patera</i>	Olympus Mons-class
NCC-301	U.S.S. <i>Pavonis Mons</i> U.S.S. <i>Grahd</i>	Olympus Mons-class Armstrong-class
	Ship that transported humanitarian aid and terraforming equipment to the starving inhabitants of Locarus VII in 2205.	
NCC-302	U.S.S. <i>Mount Cuba</i>	Olympus Mons-class
NCC-303	U.S.S. <i>Aphrodite Terra</i>	Olympus Mons-class
NCC-304	U.S.S. <i>Coprates</i>	Olympus Mons-class
NCC-305	U.S.S. <i>Drake</i>	
	Ship designated as a frigate with a crew of 164.	
	U.S.S. <i>Syria Planum</i>	Olympus Mons-class
NCC-306	U.S.S. <i>Montes Haemus</i>	Olympus Mons-class
NCC-307	U.S.S. <i>Churchill</i>	
	Ship designated as a frigate with a crew of 164.	
	U.S.S. <i>Elysium Montes</i>	Olympus Mons-class
	U.S.S. <i>Aquarius</i>	
NCC-308	U.S.S. <i>Beatty</i>	
	Ship designated as a frigate with a crew of 164.	
	U.S.S. <i>Colima</i>	Olympus Mons-class
NCC-309	U.S.S. <i>F. D. Roosevelt</i>	
	Ship designated as a frigate with a crew of 164.	
	U.S.S. <i>Green Mountain</i>	Olympus Mons-class
NCC-310	U.S.S. <i>Podish</i>	Podish-class
	First starship of her class, designated as a super-scout.	
	U.S.S. <i>Aonia Terra</i>	Olympus Mons-class
	U.S.S. <i>Lehman</i>	Okinawa-class
	U.S.S. <i>Lincoln</i>	Lincoln-class
	Cruiser starship, the first vessel of her class. Crewed by 254 people, the ship was 174m long, 63m wide and 45m high.	

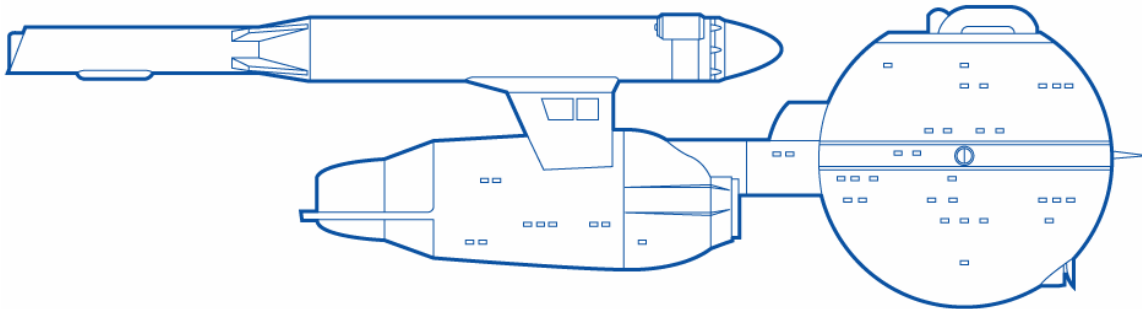

NCC-311	U.S.S. <i>Montes Alpes</i> U.S.S. <i>Utopia</i>	Olympus Mons-class Lincoln-class
---------	--	-------------------------------------

NCC-312	U.S.S. <i>Roosevelt</i>	Okinawa-class
	U.S.S. <i>Fletcher</i>	Fletcher-class
	First vessel of her class, designated a destroyer by Starfleet.	
	U.S.S. <i>Aconcagua</i>	Olympus Mons-class
	U.S.S. <i>Waterloo</i>	Lincoln-class
	Ship that due to be retired, it fell victim to a Klingon attack in the Becker system in 2224.	
NCC-313	U.S.S. <i>Graf Spee</i>	
	Ship designated as a frigate with a crew of 164.	
	U.S.S. <i>Erebus</i>	Olympus Mons-class
	U.S.S. <i>Sorbonne</i>	Lincoln-class
NCC-314	U.S.S. <i>Tegethoff</i>	
	Ship designated as a frigate with a crew of 164.	
	U.S.S. <i>Apis Tholus</i>	Olympus Mons-class
	U.S.S. <i>Liberty</i>	Lincoln-class
NCC-315	U.S.S. <i>Himalchuli</i>	Olympus Mons-class
	U.S.S. <i>Miami</i>	Lincoln-class
NCC-316	U.S.S. <i>Vesuvius</i>	Olympus Mons-class
	U.S.S. <i>Kiev</i>	Lincoln-class
NCC-317	U.S.S. <i>Hipper</i>	
	Ship designated as a frigate with a crew of 164.	
	U.S.S. <i>D'tar</i>	
	U.S.S. <i>Theia Mons</i>	Olympus Mons-class
NCC-318	U.S.S. <i>Yi Sun Sin</i>	
	Ship designated as a frigate with a crew of 164.	
	U.S.S. <i>Kamet</i>	Olympus Mons-class
	U.S.S. <i>Kiev</i>	
NCC-319	U.S.S. <i>Tanaka</i>	
	Ship designated as a frigate with a crew of 164.	
	U.S.S. <i>Mount Rainier</i>	Olympus Mons-class
NCC-320	U.S.S. <i>St. Vincent</i>	
	Ship designated as a frigate with a crew of 164.	
	U.S.S. <i>St. Helens</i>	Olympus Mons-class
NCC-321	U.S.S. <i>Var Mons</i>	Olympus Mons-class
	U.S.S. <i>Zhadnov</i>	Okinawa-class
NCC-322	U.S.S. <i>Kungur</i>	Olympus Mons-class
NCC-323	U.S.S. <i>Grossglockner</i>	Olympus Mons-class
	U.S.S. <i>Guderian</i>	
	Ship designated as a frigate with a crew of 164.	
NCC-324	U.S.S. <i>Dunnigan</i>	
	Ship designated as a frigate with a crew of 164.	
	U.S.S. <i>Zubeneschamali</i>	Bison 4-class
NCC-325	U.S.S. <i>Pherkad</i>	Bison 4-class
NCC-326	U.S.S. <i>Alphecca</i>	Bison 4-class
NCC-327	U.S.S. <i>Graffias</i>	Bison 4-class
NCC-328	U.S.S. <i>Atria</i>	Bison 4-class

NCC-329	U.S.S. <i>Villeneuve</i>	Okinawa-class
	U.S.S. <i>Sabik</i>	Bison 4-class
NCC-330	U.S.S. <i>Rickoverz</i>	Okinawa-class
	U.S.S. <i>Rasalgethi</i>	Bison 4-class
NCC-331	U.S.S. <i>Donitz</i>	
	U.S.S. <i>Shaula</i>	Bison 4-class
NCC-332	U.S.S. <i>Mallory</i>	Okinawa-class
	U.S.S. <i>Rasalhague</i>	Bison 4-class
NCC-333	U.S.S. <i>Eltanin</i>	Bison 4-class
	U.S.S. <i>Golden hind</i>	
NCC-334	U.S.S. <i>Togo</i>	Okinawa-class
	U.S.S. <i>Kaus Media</i>	Bison 4-class
NCC-335	U.S.S. <i>Harwood</i>	Okinawa-class
	U.S.S. <i>Kaus Australis</i>	Bison 4-class
	U.S.S. <i>Amsterdam</i>	
NCC-336	U.S.S. <i>Rommel</i>	Okinawa-class
	U.S.S. <i>Sheliak</i>	Bison 4-class
NCC-337	U.S.S. <i>Nunki</i>	Bison 4-class
NCC-338	U.S.S. <i>Sadr</i>	Bison 4-class
NCC-339	U.S.S. <i>Deneb Algedi</i>	Bison 4-class
NCC-340	U.S.S. <i>Al Na'ir</i>	Bison 4-class
NCC-341	U.S.S. <i>Tuverlind</i>	Tuverlind-class
	Prototype vessel of her class, designated as a superscout.	
	U.S.S. <i>Sadalbari</i>	Bison 4-class
NCC-342	U.S.S. <i>McClusky</i>	Okinawa-class
	U.S.S. <i>Skat</i>	Bison 4-class
NCC-343	U.S.S. <i>Jason</i>	Okinawa-class
	U.S.S. <i>Scheat</i>	Bison 4-class
NCC-344	U.S.S. <i>Dewey</i>	Okinawa-class
NCC-345	U.S.S. <i>DeGama</i>	Tuverlind-class
	U.S.S. <i>Degrasse</i>	Okinawa-class
NCC-346	U.S.S. <i>Suffren</i>	Okinawa-class
NCC-347	U.S.S. <i>Senyavin</i>	Okinawa-class
NCC-348	U.S.S. <i>Hosegawa</i>	Okinawa-class
NCC-349	U.S.S. <i>Shaw</i>	Okinawa-class
NCC-350	U.S.S. <i>Frobisher</i>	Frobisher-class
	First starship of her class, classified as a clipper.	
NCC-352	U.S.S. <i>Chaka</i>	Okinawa-class
NCC-353	U.S.S. <i>Cetshwayo</i>	Okinawa-class
NCC-354	U.S.S. <i>Reynolds</i>	Okinawa-class
NCC-362	U.S.S. <i>Cape Canaveral</i>	Armstrong-class
NCC-367	U.S.S. <i>Korolev</i>	Korolev-class
	First vessel of her class, classified by Starfleet as an exploratory cruiser.	
NX-374	U.S.S. <i>Moskva</i>	Moskva-class
	First vessel of her class, the <i>Moskva</i> entered service in April 2179 and was 161.23m long, 40m high and 68.32m wide. Weighing 67,750 tons, it held a crew of 198, and was well armed with laser cannons, Spartak missiles, laser	

turrets and Ultraphased pulse laser cannons. The ship was later re-registered as NCC-274 after completing trials.

NCC-375	U.S.S. <i>Orion</i>	Moskva-class
NCC-376	U.S.S. <i>Callisto</i>	Moskva-class
NCC-377	U.S.S. <i>Aurora</i>	Moskva-class
	Starship that was a participant at the historic Battle of Eohippus IV, it was later retired and placed on display at the Starfleet Museum.	
NCC-378	U.S.S. <i>Pallas</i>	Moskva-class
NCC-379	U.S.S. <i>Africa</i>	Moskva-class
NCC-380	U.S.S. <i>Thresher</i>	Moskva-class
NCC-381	U.S.S. <i>Osaka</i>	Moskva-class
NCC-382	U.S.S. <i>Johannesburg</i>	Moskva-class
NCC-383	U.S.S. <i>Titan</i>	Moskva-class
NCC-384	U.S.S. <i>Theiss</i>	Moskva-class
NCC-385	U.S.S. <i>Nostramo</i>	Moskva-class
NCC-386	U.S.S. <i>San Francisco</i>	Moskva-class
NCC-387	U.S.S. <i>Skorzeny</i>	Okinawa-class
	U.S.S. <i>Gato</i>	Moskva-class
NCC-388	U.S.S. <i>Kripney</i>	Okinawa-class
	U.S.S. <i>Vincennes</i>	Moskva-class
NCC-389	U.S.S. <i>Roger Young</i>	Okinawa-class
	U.S.S. <i>America</i>	Moskva-class
NCC-390	U.S.S. <i>Sulaco</i>	Okinawa-class
	U.S.S. <i>Von Braun</i>	Moskva-class
NCC-391	U.S.S. <i>Susan Calvin</i>	Moskva-class
NCC-392	U.S.S. <i>Tyrell</i>	Moskva-class
NCC-393	U.S.S. <i>Ganymede</i>	Moskva-class
NCC-394	U.S.S. <i>Metropolis</i>	Moskva-class
NCC-395	U.S.S. <i>Apollo</i>	Moskva-class
NCC-396	U.S.S. <i>Barsoon</i>	Moskva-class
NCC-397	U.S.S. <i>Thunderchild</i>	Moskva-class
NCC-398	U.S.S. <i>Seymour Cray</i>	Moskva-class
NCC-399	U.S.S. <i>McManus</i>	Moskva-class
NCC-400	U.S.S. <i>Wah Chang</i>	Moskva-class
NCC-401	U.S.S. <i>Ingraham</i>	Moskva-class
NCC-402	U.S.S. <i>Vostok</i>	Moskva-class
NCC-403	U.S.S. <i>Shanghai</i>	Moskva-class
NCC-404	U.S.S. <i>O'Connor</i>	Okinawa-class
	U.S.S. <i>Trumbull</i>	Moskva-class
NCC-406	U.S.S. <i>Yi-Chun</i>	Okinawa-class
NCC-407	U.S.S. <i>Manstein</i>	Okinawa-class
NCC-410	U.S.S. <i>Higgins</i>	Okinawa-class
NCC-412	U.S.S. <i>Marco Polo</i>	Tycho Brahe-class
	A transport/tug vessel.	
NCC-416	U.S.S. <i>Jackson</i>	Okinawa-class
NCC-417	U.S.S. <i>Schwarzkopf</i>	Okinawa-class
NCC-420	U.S.S. <i>Hall</i>	Okinawa-class

NCC-424	U.S.S. <i>Pompeii</i>	Saladin-class
	MT-1 Federation destroyer with a crew compliment of 200. It was destroyed.	
NCC-430	U.S.S. <i>Pleiades</i>	Pleiades-class
	First vessel of her class, designated a survey cruiser.	

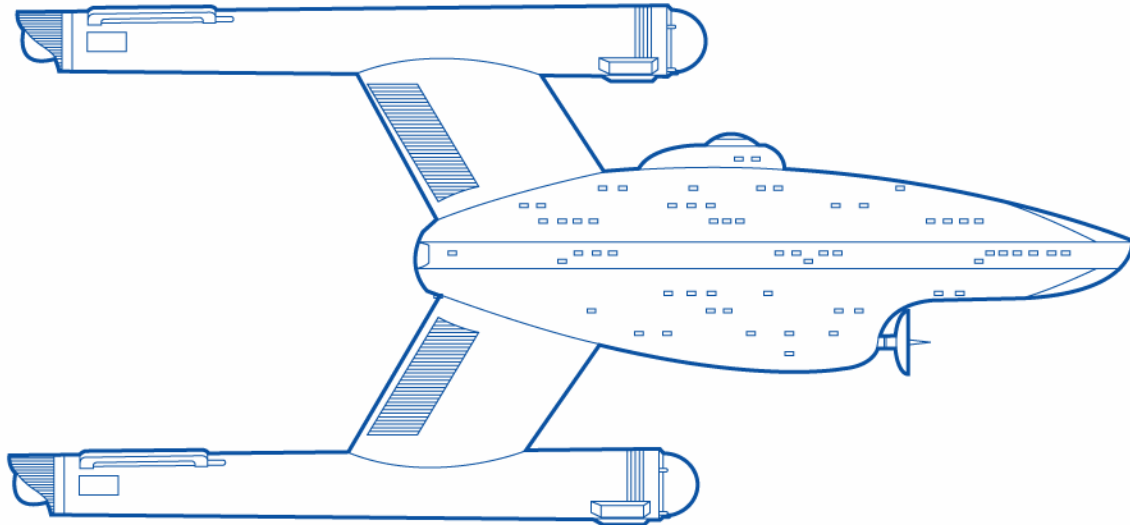

NCC-431	U.S.S. <i>Apollus</i>	Pleiades-class
NCC-432	U.S.S. <i>Starplotter</i>	Pleiades-class
NCC-433	U.S.S. <i>Arayus</i>	Pleiades-class
NCC-434	U.S.S. <i>Plocyonus</i>	Pleiades-class
NCC-435	U.S.S. <i>Questar</i>	Pleiades-class
NCC-436	U.S.S. <i>Starranger</i>	Pleiades-class
NCC-437	U.S.S. <i>Trobranur</i>	Pleiades-class
NCC-438	U.S.S. <i>Prominence</i>	Pleiades-class
NCC-439	U.S.S. <i>Eclipse</i>	Pleiades-class
NCC-440	U.S.S. <i>Idunas</i>	Pleiades-class
NCC-441	U.S.S. <i>Cobrus</i>	Pleiades-class
NCC-442	U.S.S. <i>Vortex</i>	Pleiades-class
NCC-443	U.S.S. <i>Eurandus</i>	Pleiades-class
NCC-444	U.S.S. <i>Missouri</i>	Missouri-class
	First vessel of her class.	
	U.S.S. <i>Braudos</i>	Pleiades-class
NCC-445	U.S.S. <i>Ashnar</i>	Pleiades-class
NCC-446	U.S.S. <i>Commendation</i>	Pleiades-class
NCC-447	U.S.S. <i>Completion</i>	Pleiades-class
NCC-448	U.S.S. <i>Searcher</i>	Pleiades-class
NCC-449	U.S.S. <i>Concern</i>	Pleiades-class
NCC-450	U.S.S. <i>Starrover</i>	Pleiades-class
NCC-451	U.S.S. <i>Orion</i>	Pleiades-class
	U.S.S. <i>Mitchell</i>	
	Upgraded frigate with a crew of 241.	
NCC-452	U.S.S. <i>Cordova</i>	Pleiades-class
	U.S.S. <i>Mack</i>	
	Upgraded frigate with a crew of 241	

NCC-453	U.S.S. <i>Foundation</i> U.S.S. <i>LtCol Oliver North</i> Upgraded frigate with a crew of 241	Pleiades-class
NCC-454	U.S.S. <i>Odyssey</i> U.S.S. <i>Byng</i> Upgraded frigate with a crew of 241	Pleiades-class
NCC-455	U.S.S. <i>Rheesa</i> U.S.S. <i>Mathews</i> Upgraded frigate with a crew of 241	Pleiades-class
NCC-456	U.S.S. <i>Viking</i> U.S.S. <i>Dreyfus</i> Upgraded frigate with a crew of 241	Pleiades-class
NCC-457	U.S.S. <i>Creeta</i> U.S.S. <i>Kimmel</i> Upgraded frigate with a crew of 241	Pleiades-class
NCC-458	U.S.S. <i>Pilgrim</i> U.S.S. <i>Rickover</i> Upgraded frigate with a crew of 241	Pleiades-class
NCC-459	U.S.S. <i>Medallion</i> U.S.S. <i>Ralph Hayes</i> Upgraded frigate with a crew of 241	Pleiades-class
NCC-460	U.S.S. <i>Kovaris</i> First vessel of her class, a destroyer.	Kovaris-class
NCC-471	U.S.S. <i>Observer</i> U.S.S. <i>Marko Ramus</i> Battle frigate with a crew compliment of 185.	Pleiades-class
NCC-472	U.S.S. <i>Greer</i> Prototype of the Greer-class, designated a corsair.	Greer-class corsair.
NCC-473	U.S.S. <i>Gunter Prien</i> Battle frigate with a crew compliment of 185.	
NCC-474	U.S.S. <i>Joeph Enright</i> Battle frigate with a crew compliment of 185.	
NCC-479	U.S.S. <i>Discovery</i> A scout type vessel.	
NCC-482	U.S.S. <i>Burlingame</i> A scout type vessel.	
NCC-484	U.S.S. <i>Challenger</i> A scout type vessel.	
NCC-488	U.S.S. <i>Atlantis</i> A scout type vessel.	
NX-500	----- Unnamed propulsion test ship, its features included a 45% more efficient impulse drive and a very experimental "intra-warp" drive. While the ship was destroyed during testing in 2269, all 8 crew were saved.	

NCC-500

U.S.S. *Saladin*

Saladin-class

First vessel of her class, designated a destroyer, the *Saladin* had a crew of 200, a DWT of 95,000 metric tonnes and was 242.5m long. James T. Kirk commanded this vessel early in his career.

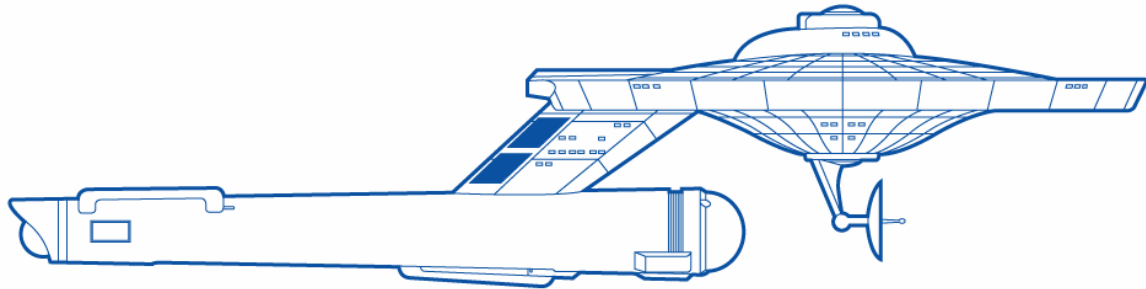

NCC-501

U.S.S. *Antares*

Science vessel under the command of Captain Ramart. It was destroyed in 2266 when a baffle plate on its energy pile vanished thanks to a young man named Charlie, whom the *Antares* had just transferred to the U.S.S. *Enterprise* NCC-1701.

NCC-502

U.S.S. *Jenghiz*

Saladin-class

U.S.S. *Darius*

Saladin-class

U.S.S. *Gagarin*

Gagarin-class

Starship, the first of her class. A light cruiser, it was constructed at the Tezuka-Republic Shipyards in Earth orbit above Singapore and joined Starfleet in 2184. The ship was 122m long, 60m wide and 29m high, with a crew compliment of 90. The ship weighed 30,100 metric tons.

NCC-503

U.S.S. *Alaric*

Saladin-class

U.S.S. *Shepard*

Gagarin-class

NCC-504

U.S.S. *Sargon*

Saladin-class

U.S.S. *Titov*

Gagarin-class

U.S.S. *Nikolai*

NCC-505

U.S.S. *Xerxes*

Saladin-class

U.S.S. *Glenn*

Gagarin-class

NCC-506

U.S.S. *Pompey*

Saladin-class

U.S.S. *Grissom*

Gagarin-class

NCC-507

U.S.S. *Kublai*

Saladin-class

Former posting of Hikaru Sulu, during which time it visited both Sigma Chi XIV and Gamma Lambda II, as well as Iota Tau Psi.

NCC-508

U.S.S. *Leonov*

Gagarin-class

U.S.S. *Suleiman*

Saladin-class

Starship commanded by "Number One" during a potential Romulan incursion.

NCC-509

U.S.S. *Tereshkova*

Gagarin-class

U.S.S. *Etsel*

Saladin-class

U.S.S. *Lovell*

Gagarin-class

NCC-510

U.S.S. *Tamerlane*

Saladin-class

U.S.S. *Komarov*

Gagarin-class

NCC-511

U.S.S. *Alexander*

Saladin-class

U.S.S. *Dobrovolsky*

Gagarin-class

NCC-512

U.S.S. *Hannibal*

Saladin-class

U.S.S. *Borman*

Gagarin-class

NCC-513	U.S.S. <i>Ahriman</i>	Saladin-class
	U.S.S. <i>Collins</i>	Gagarin-class
NCC-514	U.S.S. <i>Rahman</i>	Saladin-class
	U.S.S. <i>Christopher</i>	Gagarin-class
NCC-515	U.S.S. <i>Adad</i>	Saladin-class
	U.S.S. <i>Richey</i>	Gagarin-class
NCC-516	U.S.S. <i>Hashishiyun</i>	Saladin-class
	U.S.S. <i>Archytas</i>	Gagarin-class
NCC-517	U.S.S. <i>Azrael</i>	Saladin-class
	Former posting of Nyota Uhura early in her career. The vessel's phaser cannons were retrofitted in construction orbit in October of 2264.	
	U.S.S. <i>Kai-fung-fu</i>	Gagarin-class
NCC-518	U.S.S. <i>Hamilcar</i>	Saladin-class
	U.S.S. <i>Al-Rammah</i>	Gagarin-class
NCC-519	U.S.S. <i>Shaitan</i>	Saladin-class
	U.S.S. <i>Fontana</i>	Gagarin-class
NCC-520	U.S.S. <i>Siva</i>	Siva-class
	The Siva-class of vessel is a technological advancement of the Saladin-class.	
	U.S.S. <i>Haas</i>	Gagarin-class
NCC-521	U.S.S. <i>Pazuzu</i>	Akula-class
	U.S.S. <i>Lucifer</i>	Siva-class
	U.S.S. <i>Hyder Ali</i>	Gagarin-class
NCC-522	U.S.S. <i>Molock</i>	Siva-class
	U.S.S. <i>Congreve</i>	Gagarin-class
NCC-523	U.S.S. <i>Hathor</i>	Siva-class
	U.S.S. <i>Ruggieri</i>	Gagarin-class
NCC-524	U.S.S. <i>Ares</i>	Siva-class
	U.S.S. <i>Delhi</i>	Lincoln-class
	U.S.S. <i>Burney</i>	Gagarin-class
NCC-525	U.S.S. <i>Mars</i>	Siva-class
	Jose Domingues served aboard this vessel in 2251.	
	U.S.S. <i>Passat</i>	Lincoln-class
	U.S.S. <i>Golightly</i>	Gagarin-class
NCC-526	U.S.S. <i>Brigham Young</i>	Akula-class
	U.S.S. <i>Tyr</i>	Siva-class
	U.S.S. <i>Osaka</i>	Lincoln-class
	U.S.S. <i>Goddard</i>	Gagarin-class
	The <i>Goddard</i> joined Starfleet Academy as a training ship, but was retired and scrapped in 2266 after a reactor accident in which several cadets and instructors were killed or severely injured.	
NCC-527	U.S.S. <i>Sadat</i>	Akula-class
	U.S.S. <i>Jugurtha</i>	Siva-class
	U.S.S. <i>Cheron</i>	Lincoln-class
	U.S.S. <i>Tsiolkovsky</i>	Gagarin-class
NCC-528	U.S.S. <i>Czar Nicholas</i>	Akula-class
	U.S.S. <i>Iblis</i>	Siva-class
	U.S.S. <i>Aurora</i>	Lincoln-class
	U.S.S. <i>Oberth</i>	Gagarin-class

NCC-529	U.S.S. <i>Skanderbeg</i>	Akula-class
	U.S.S. <i>Loki</i>	Siva-class
	U.S.S. <i>Hamburg</i>	Lincoln-class
	U.S.S. <i>Korolev</i>	Gagarin-class
NCC-530	U.S.S. <i>Cochise</i>	Cochise-class
	The Cochise-class of vessel is a technological advancement of the Saladin-class. It was commanded by Captain Micah Chandler in 2268 during the "Interstellar Shortcut" incident. The ship remained in service until at least 2285.	
	U.S.S. <i>Sirius</i>	Lincoln-class
	U.S.S. <i>Sanger</i>	Gagarin-class
NCC-531	U.S.S. <i>Alva</i>	Cochise-class
	U.S.S. <i>Ley</i>	Gagarin-class
NCC-532	U.S.S. <i>Pontiac</i>	Cochise-class
	U.S.S. <i>Montgolfier</i>	Gagarin-class
NCC-533	U.S.S. <i>Isreal Putnam</i>	Akula-class
	U.S.S. <i>Ney</i>	Cochise-class
	U.S.S. <i>Lilienthal</i>	Gagarin-class
NCC-534	U.S.S. <i>El Cid</i>	Cochise-class
	U.S.S. <i>Weisskopf</i>	Gagarin-class
NCC-535	U.S.S. <i>Suvarov</i>	Akula-class
	U.S.S. <i>Geronimo</i>	Cochise-class
	U.S.S. <i>Wright</i>	Gagarin-class
NCC-536	U.S.S. <i>Cortez</i>	Cochise-class
	U.S.S. <i>Re Lee</i>	Rising Star-class
	U.S.S. <i>Santos-Dumont</i>	Gagarin-class
NCC-537	U.S.S. <i>Alvarado</i>	Cochise-class
	U.S.S. <i>Zepplin</i>	Gagarin-class
NCC-538	U.S.S. <i>De Ruyter</i>	Cochise-class
	U.S.S. <i>Leonidus</i>	Rising Star-class
	U.S.S. <i>Sikorsky</i>	Gagarin-class
NCC-539	U.S.S. <i>Marius</i>	Akula-class
	U.S.S. <i>Hektor</i>	Cochise-class
	U.S.S. <i>Bleriot</i>	Gagarin-class
	The <i>Bleriot</i> made first contact with 12 races, and was displayed at the Starfleet Museum.	
NCC-540	U.S.S. <i>Lysander</i>	Cochise-class
	Commanded by Captain Mohammed Tafari in 2269 during the search for the U.S.S. <i>Intrepid</i> .	
	U.S.S. <i>David</i>	Akula-class
	U.S.S. <i>King David</i>	Rising Star-class
	U.S.S. <i>Earhart</i>	Gagarin-class
NCC-541	U.S.S. <i>Drake</i>	Cochise-class
	U.S.S. <i>David</i>	Rising Star-class
	U.S.S. <i>Yeager</i>	Gagarin-class
NCC-542	U.S.S. <i>Appollyon</i>	Cochise-class
NCC-543	U.S.S. <i>Samson</i>	Cochise-class
NCC-544	U.S.S. <i>Perseus</i>	Cochise-class

NCC-545	U.S.S. <i>Centurion</i> This starship was destroyed.	Constitution-class
	U.S.S. <i>Al Mahdi</i>	Cochise-class
NCC-546	U.S.S. <i>Nelson</i>	Cochise-class
NCC-547	U.S.S. <i>Ajax</i>	Cochise-class
NCC-548	U.S.S. <i>Akbar</i>	Cochise-class
NCC-549	U.S.S. <i>Abu Bekr</i>	Cochise-class
NCC-550	U.S.S. <i>Ivan</i>	Cochise-class
NCC-551	U.S.S. <i>Achilles</i> Destroyed in 2254 at Theta Kalyb.	Cochise-class
NCC-552	U.S.S. <i>Theseus</i>	Cochise-class
NCC-553	U.S.S. <i>Scipio</i>	Cochise-class
NCC-554	U.S.S. <i>Martel</i>	Cochise-class
NCC-555	U.S.S. <i>Cimon</i>	Cochise-class
NCC-556	U.S.S. <i>Guannada</i> Ship classified as a destroyer.	Jenghiz-class
NCC-559	U.S.S. <i>Steven Barnes</i> Commanded by Captain Kenneth Mac Alpine, Montgomery Scott served on this starship, during which time the ship visited the Tau Ceti region.	Saladin-class
NCC-561	U.S.S. <i>Coridan Queen</i> Ship that was launched in 2243 as the vessel <i>Lodestar IX</i> by Lockheed Spaceframes Inc. It was later renamed the <i>Spacebird</i> , when it made the Earth-Mars run from 2254 to 2261. It then became a Starfleet ship as the <i>Coridan Queen</i> . Montgomery Scott served on this vessel, during which time it visited Gamma Theta IX and New Bavaria.	Saladin-class
NCC-564	U.S.S. <i>Providence</i>	
NCC-565	U.S.S. <i>Halsey</i> A destroyer/escort with a crew of 204, the ship was an escort for the U.S.S. <i>Nimitz</i> (NCC-1951).	
	U.S.S. <i>Seoul</i>	
NCC-566	U.S.S. <i>Nagumo</i> A destroyer/escort with a crew of 204, the ship was an escort for the U.S.S. <i>Yamamoto</i> (NCC-1952).	
	U.S.S. <i>Bismarck</i>	
NCC-567	U.S.S. <i>Altair</i>	
NCC-568	U.S.S. <i>Ulysses</i>	
NCC-569	U.S.S. <i>Sumatra</i>	
NCC-570	U.S.S. <i>Atlas</i>	
NCC-571	U.S.S. <i>Alpha Centauri</i>	
NCC-580	U.S.S. <i>Warlord</i> First vessel of her class, designated a heavy destroyer. The ship was armed with one megaphaser emplacement, six dual phaser banks and four photon torpedo launchers. The ship, crewed by 325 people, weighed 130,000 metric tonnes. The ship was 200m long, 141.7m wide and 70.3m high.	Warlord-class
NCC-581	U.S.S. <i>Gaught</i>	Warlord-class
NCC-582	U.S.S. <i>Rusak</i>	Warlord-class
NCC-583	U.S.S. <i>Esch</i>	Warlord-class
NCC-584	U.S.S. <i>Nieto</i>	Warlord-class
NCC-585	U.S.S. <i>Hermes</i> Pathfinder vessel of her class, similar in dimension to the Saladin-class.	Hermes-class

NCC-586	U.S.S. <i>Anubis</i>	Hermes-class
NCC-587	U.S.S. <i>DeGama</i>	Hermes-class
NCC-588	U.S.S. <i>Aeolus</i>	Hermes-class
NCC-589	U.S.S. <i>Diana</i>	Hermes-class
NCC-590	U.S.S. <i>Quintilus</i>	Hermes-class
NCC-591	U.S.S. <i>Bridger</i>	Hermes-class
NCC-592	U.S.S. <i>Carson</i>	Hermes-class
NCC-593	U.S.S. <i>Batidor</i>	Hermes-class
NCC-594	U.S.S. <i>Cody</i>	Hermes-class
	Starship based out of Starbase 2.	
NCC-595	U.S.S. <i>Revere</i>	Hermes-class
	Assigned by Commodore Probert to rendezvous with the U.S.S. <i>Columbia</i> (NCC-621) shortly prior to stardate 7411.4.	
NCC-596	U.S.S. <i>Spaker</i>	Hermes-class
NCC-597	U.S.S. <i>Bowie</i>	Hermes-class
	Starship that was commanded by "Number One" during a Fleet engagement with the Klingons.	
NCC-598	U.S.S. <i>Sacajawea</i>	Hermes-class
	Former posting of Hikaru Sulu.	
NCC-599	U.S.S. <i>Tonti</i>	Hermes-class
NCC-600	U.S.S. <i>Crockett</i>	Hermes-class
	During an engagement with the Klingons, Lt. Barbara Omen was killed. Also a former posting of Hikaru Sulu.	
NCC-601	U.S.S. <i>Monoceros</i>	Monoceros-class
	The Monoceros -class of vessel is a technological advancement of the Hermes-class.	
NCC-602	U.S.S. <i>Oberth</i>	Oberth-class
	First vessel of her class. A scout, the <i>Oberth</i> had 11 decks, and was 160m long, with a crew of 80. On stardate 9521, the ship was on a deep-space exploration mission.	

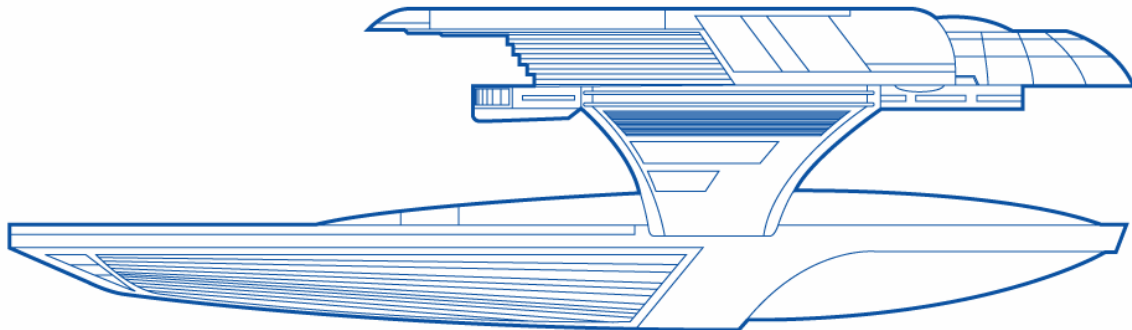

	U.S.S. <i>Aries</i>	Monoceros-class
NCC-603	U.S.S. <i>Equulus</i>	Monoceros-class
NCC-604	U.S.S. <i>Lupus</i>	Monoceros-class
NCC-605	U.S.S. <i>Taurus</i>	Monoceros-class
NCC-606	U.S.S. <i>Camelopardus</i>	Monoceros-class
NCC-607	U.S.S. <i>Garibaldi</i>	Monoceros-class
NCC-608	U.S.S. <i>Lynx</i>	Monoceros-class
NCC-609	U.S.S. <i>Ursa Major</i>	Monoceros-class
NCC-610	U.S.S. <i>Lepus</i>	Monoceros-class

NCC-611	U.S.S. <i>Canis Major</i>	Monoceros-class
NCC-612	U.S.S. <i>Pegasus</i>	Monoceros-class
	U.S.S. <i>Terni</i>	
NCC-613	U.S.S. <i>Vulpecula</i>	Monoceros-class
NCC-614	U.S.S. <i>Leo Minor</i>	Monoceros-class
NCC-615	U.S.S. <i>Canis Minor</i>	Monoceros-class
NCC-616	U.S.S. <i>Ursa Minor</i>	Monoceros-class
NCC-617	U.S.S. <i>Cygnus</i>	Cygnus-class
	The Cygnus -class of vessel is a technological advancement of the Hermes-class.	
	U.S.S. <i>Lagrange</i>	Oberth-class
NCC-618	U.S.S. <i>Apus</i>	Cygnus-class
	U.S.S. <i>Hawking</i>	Oberth-class
	U.S.S. <i>Lake</i>	Oberth-class
NCC-619	U.S.S. <i>Tucana</i>	Cygnus-class
NCC-620	U.S.S. <i>Corvus</i>	Cygnus-class
NCC-621	U.S.S. <i>Columbia</i>	Cygnus-class
	Ship ordered by Commodore Probert to rendezvous with the U.S.S. <i>Revere</i> (NCC-595) just prior to stardate 7411.4.	
NCC-622	U.S.S. <i>Pavo</i>	Cygnus-class
NCC-623	U.S.S. <i>Copernicus</i>	Oberth-class
	Starship that was in Spacedock, Earth, when the second starship <i>Enterprise</i> (NCC-1701-A) was launched in 2286.	
	U.S.S. <i>Aquila</i>	Cygnus-class
NCC-624	U.S.S. <i>Grus</i>	Cygnus-class
NCC-625	U.S.S. <i>Phoenix</i>	Cygnus-class
NCC-626	U.S.S. <i>Amerind</i>	Amerind-class
	First vessel of her class, designated a scout ship.	
NCC-627	U.S.S. <i>Linecum</i>	Amerind-class
NCC-628	U.S.S. <i>Gallaway</i>	Amerind-class
NCC-629	U.S.S. <i>Inglesias</i>	Amerind-class
NCC-630	U.S.S. <i>Gagarin</i>	Gagarin-class
	First vessel of her class, classified as a research vessel.	
	U.S.S. <i>Garneau</i>	Garneau-class
	First vessel of her class, designated a survey vessel. Weighing 41,000metric tonnes, it was 148m long, 103m wide and 59 m high, with a crew of 80.	
	U.S.S. <i>Komarov</i>	Komarov-class
	First vessel of her class, designated a superscout.	
NCC-631	U.S.S. <i>Shepard</i>	Oberth-class
NCC-632	U.S.S. <i>Glenn</i>	Gagarin-class
NCC-633	U.S.S. <i>Carpen</i>	Gagarin-class
NCC-634	U.S.S. <i>Schirra</i>	
NCC-635	U.S.S. <i>Cooper</i>	
NCC-636	U.S.S. <i>Easter</i>	Gagarin-class
NCC-637	U.S.S. <i>Tereshkova</i>	Gagarin-class
NCC-638	U.S.S. <i>Grissom</i>	Oberth-class
	Science vessel launched in 2269, command of this ship was originally offered to Spock, who declined. The <i>Grissom</i> was destroyed in 2285 at the newly-formed Genesis Planet while under the command of Captain J.T. Esteban.	
NCC-639	U.S.S. <i>Titov</i>	Gagarin-class

NCC-640	U.S.S. <i>Robinett</i>	Gagarin-class
NCC-641	U.S.S. <i>Paruchuri</i>	Gagarin-class
NCC-642	U.S.S. <i>Hartgraves</i>	Gagarin-class
NCC-643	U.S.S. <i>Ariel</i>	Oberth-class
	U.S.S. <i>Nowell</i>	
NCC-644	U.S.S. <i>Thaxton</i>	Gagarin-class
	U.S.S. <i>Syracuse</i>	Oberth-class
NCC-645	U.S.S. <i>Krusinsky</i>	Gagarin-class
NCC-646	U.S.S. <i>Qazi</i>	Gagarin-class
NCC-647	U.S.S. <i>Irons</i>	Gagarin-class
NCC-648	U.S.S. <i>Villalobos</i>	Gagarin-class
NCC-649	U.S.S. <i>Lockhart</i>	Gagarin-class
NCC-650	U.S.S. <i>Toscana</i>	Gagarin-class
NCC-651	U.S.S. <i>Donovan</i>	
	An improved-technology scout with a crew compliment of 302.	
	U.S.S. <i>Gehlen</i>	
	An improved-technology scout with a crew compliment of 302.	
	U.S.S. <i>Hass</i>	Gagarin-class
NCC-652	U.S.S. <i>Darwin</i>	Darwin-class
	First starship of her class, classified as a scout.	
	U.S.S. <i>Gehlen</i>	
	An improved-technology scout with a crew compliment of 302.	
NCC-653	U.S.S. <i>Casey</i>	
	An improved-technology scout with a crew compliment of 302.	
	U.S.S. <i>Libby</i>	Darwin-class
NCC-654	U.S.S. <i>Dzherzinski</i>	
	An improved-technology scout with a crew compliment of 302.	
	U.S.S. <i>Peacock</i>	Darwin-class
NCC-655	U.S.S. <i>Canaris</i>	
	An improved-technology scout with a crew compliment of 302.	
	U.S.S. <i>Ronhausen</i>	Darwin-class
NCC-656	U.S.S. <i>Thompson</i>	
	An improved-technology scout with a crew compliment of 302.	
	U.S.S. <i>Kyre</i>	Darwin-class
NCC-657	U.S.S. <i>Manahan</i>	Darwin-class
NCC-658	U.S.S. <i>Ott</i>	Darwin-class
NCC-659	U.S.S. <i>Tarkenton</i>	Darwin-class
NCC-660	U.S.S. <i>Janow</i>	Darwin-class
NCC-661	U.S.S. <i>Quijeno</i>	Darwin-class
NCC-662	U.S.S. <i>Lalonde</i>	Darwin-class
NCC-663	U.S.S. <i>Sapien</i>	Darwin-class
NCC-664	U.S.S. <i>Harvison</i>	Darwin-class
	U.S.S. <i>Lowell</i>	Oberth-class
NCC-665	U.S.S. <i>Nzere</i>	Darwin-class
NCC-666	U.S.S. <i>Patentote</i>	Darwin-class
NCC-667	U.S.S. <i>Kuo-Ching</i>	Darwin-class
NCC-668	U.S.S. <i>Owinyo</i>	Darwin-class

NCC-669	U.S.S. <i>Makewicz</i>	Darwin-class
NCC-670	U.S.S. <i>Rousseau</i>	Darwin-class
NCC-671	U.S.S. <i>Jaramillo</i>	Darwin-class
NCC-672	U.S.S. <i>Quattlebaum</i>	Darwin-class
NCC-673	U.S.S. <i>Scribner</i>	Darwin-class
NCC-674	U.S.S. <i>Lacrosse</i>	Darwin-class
NCC-675	U.S.S. <i>Nonweiler</i>	Gagarin-class
NCC-676	U.S.S. <i>Omohundro</i>	Gagarin-class
NCC-677	U.S.S. <i>Kopp</i>	Gagarin-class
NCC-678	U.S.S. <i>Sparling</i>	Gagarin-class
NCC-679	U.S.S. <i>McAden</i>	
NCC-680	U.S.S. <i>Sato</i>	Gagarin-class
NCC-681	U.S.S. <i>Harrienger</i>	Gagarin-class
	U.S.S. <i>Ve'hal</i>	Oberth-class
NCC-682	U.S.S. <i>Rotauris</i>	Gagarin-class
NCC-683	U.S.S. <i>Orum</i>	Gagarin-class
	U.S.S. <i>Kidder</i>	
NCC-684	U.S.S. <i>Lowdermilk</i>	Gagarin-class
NCC-685	U.S.S. <i>Nix</i>	Gagarin-class
NCC-686	U.S.S. <i>Peikert</i>	
NCC-687	U.S.S. <i>Jezesick</i>	Gagarin-class
NCC-688	U.S.S. <i>Norvelle</i>	Gagarin-class
NCC-689	U.S.S. <i>O'Quinn</i>	Gagarin-class
NCC-690	U.S.S. <i>Magee</i>	Gagarin-class
NCC-691	U.S.S. <i>Nuegebauer</i>	Gagarin-class
NCC-692	U.S.S. <i>Knode</i>	Gagarin-class
NCC-700	U.S.S. <i>Legion</i>	Legion-class
	First starship of her class, a carrier.	
NCC-701	U.S.S. <i>Prince of Wales</i>	
	An improved-technology scout ship with a crew of 302.	
NCC-702	U.S.S. <i>Lexington</i>	
	An improved-technology scout ship with a crew of 302.	
NCC-703	U.S.S. <i>Kongo</i>	
	An improved-technology scout ship with a crew of 302.	
NCC-704	U.S.S. <i>Essex</i>	
	An improved-technology scout ship with a crew of 302.	
NCC-705	U.S.S. <i>Republic</i>	
	An improved-technology scout ship with a crew of 302.	
NCC-706	U.S.S. <i>Potemkin</i>	
	An improved-technology scout ship with a crew of 302.	
NCC-709	U.S.S. <i>Sub-Galaxy</i>	Sub-Galaxy-class
	Starship, first of her class. The ship had a crew compliment of 75. The ship was armed with 2 phaser banks fore, 1 aft. Its shuttle compliment was one vehicle.	
NCC-710	U.S.S. <i>Ianetos</i>	Ianetos-class
	First vessel of her class, classified as a superscout.	
NCC-715	U.S.S. <i>Oxford</i>	Coventry-class
	An upgraded frigate.	

- NCC-717 U.S.S. *Antares*
Small scout vessel.
- NCC-721 U.S.S. *Columbia*
Starship, eventually retired from duty. It was one of several vessels to bear the name.
- NCC-745 U.S.S. *Cahuya*
A science/survey vessel.

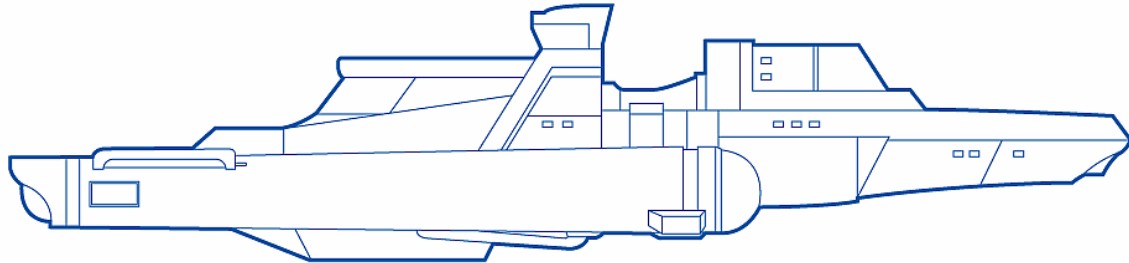

- NCC-750 U.S.S. *Caracal* Caracal-class
First vessel of the class, classified as a cruiser.
- NCC-751 U.S.S. *Oxford* Miranda-class
Starship commanded at one time by James T. Kirk.
- U.S.S. *Navangar* Caracal-class
- NCC-752 U.S.S. *Spartan* Caracal-class
- NCC-753 U.S.S. *Reliance* Caracal-class
- NCC-754 U.S.S. *Allegany* Caracal-class
- NCC-755 U.S.S. *Matanzas* Caracal-class
- NCC-756 U.S.S. *Saphir* Caracal-class
- NCC-757 U.S.S. *Audace* Caracal-class
- NCC-758 U.S.S. *Requin* Caracal-class
- NCC-759 U.S.S. *Arroyo* Caracal-class
- NCC-760 U.S.S. *Palomar* Caracal-class
- NCC-761 U.S.S. *Salk*
Starfleet medical vessel that assisted survivors from Starbase 14 on stardate 6222.
- U.S.S. *Long Beach* Caracal-class
- NCC-762 U.S.S. *Magellanic* Celestial-class
Vessel classified as a heavy cruiser.
- U.S.S. *Tayi* Caracal-class
- NCC-763 U.S.S. *Dominium* Caracal-class
- NCC-764 U.S.S. *R'sah-Dani* Caracal-class
- NCC-722 U.S.S. *Algol* Antares-class
Commanded by Captain Jen Weman.
- NCC-781 U.S.S. *Ranger* Ranger-class
First vessel of her class, this cruiser entered service in 2215. The ship was 135.6m long, 44.5m wide and 28.8m high, with a crew compliment of 287.
- NCC-786 U.S.S. *Roma* Lincoln-class
- NCC-787 U.S.S. *Sofia* Lincoln-class
- NCC-788 U.S.S. *Ariel* Lincoln-class
- NCC-800 U.S.S. *Schmidt* Schmidt-class
First vessel of the class, classified by Starfleet as a tug.
- NCC-801 U.S.S. *Begin* Akula-class

NCC-802	U.S.S. <i>Betelgeuse</i>	Antares-class
NCC-803	U.S.S. <i>Tudjman</i>	Rising Star-class
NCC-805	U.S.S. <i>Shevardnadze</i>	Rising-Star-class
NCC-806	U.S.S. <i>Santa Fe</i>	Schmidt-class
NCC-811	U.S.S. <i>Bastion</i>	Ranger-class
	Destroyed in 2228 near the Mutara Nebula after destroying five Klingon cruisers.	
	U.S.S. <i>John Ross</i>	Antares-class
	Starship originally named <i>Zeta Reticulum</i> .	
NCC-820	U.S.S. <i>Kiaga</i>	Kiaga-class
	First starship of her class, classified as a perimeter-action vessel.	
NCC-831	U.S.S. <i>Massoud</i>	Ortega-class
	Drone bombardment destroyer with a crew compliment of 205.	
NCC-832	U.S.S. <i>Hekmatyar</i>	Ortega-class
NCC-833	U.S.S. <i>Yunis Khalis</i>	Ortega-class
NCC-834	U.S.S. <i>Najibullah</i>	Ortega-class
NCC-835	U.S.S. <i>Rabbani</i>	Ortega-class
NCC-836	U.S.S. <i>Mojadeddi</i>	Ortega-class
NCC-837	U.S.S. <i>Dostam</i>	Ortega-class
NCC-838	U.S.S. <i>Hwicce</i>	Kiaga-class
NCC-841	U.S.S. <i>Siirt</i>	Kiaga-class
NCC-848	U.S.S. <i>Korinthos</i>	Kiaga-class
NCC-851	U.S.S. <i>Hyperion</i>	Hyperion-class
	Cruiser, the first ship of her class. 204m long, 86m wide and 47m high, the ship's displacement was 79,227 tons. Its crew compliment was 178.	

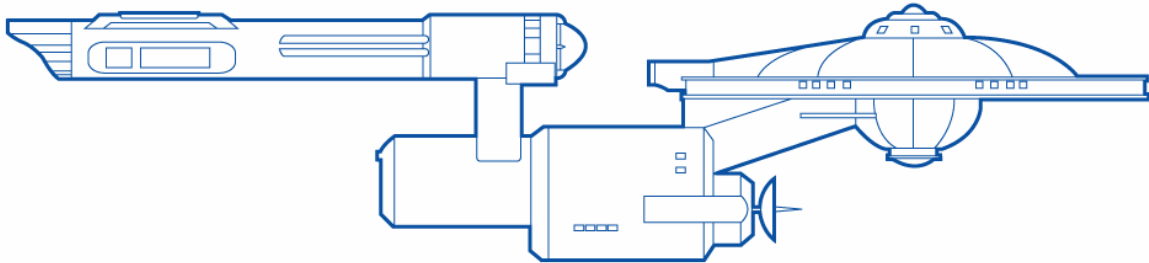

NCC-852	U.S.S. <i>Athena</i>	Hyperion-class
NCC-853	U.S.S. <i>Iapetus</i>	Hyperion-class
NCC-854	U.S.S. <i>Reagan</i>	Akula-class
	U.S.S. <i>Oceanus</i>	Hyperion-class
NCC-855	U.S.S. <i>Agilis</i>	Agilis-class
	First vessel of the class, designated a perimeter action vessel.	
	U.S.S. <i>Thatcher</i>	Akula-class
	U.S.S. <i>Pegasus</i>	
	U.S.S. <i>Zeus</i>	Hyperion-class
NCC-856	U.S.S. <i>Gaia</i>	Hyperion-class
NCC-857	U.S.S. <i>Theia</i>	Hyperion-class
NCC-858	U.S.S. <i>Rhea</i>	Hyperion-class
NCC-859	U.S.S. <i>Patria</i>	
	U.S.S. <i>Hercules</i>	Hyperion-class
NCC-860	U.S.S. <i>Phoebe</i>	Hyperion-class

NCC-861	U.S.S. <i>Tethys</i>	Hyperion-class
NCC-862	U.S.S. <i>Ashikaga</i>	
	U.S.S. <i>Poseidon</i>	Hyperion-class
NCC-863	U.S.S. <i>Selene</i>	Hyperion-class
NCC-864	U.S.S. <i>Cronus</i>	Hyperion-class
NCC-865	U.S.S. <i>Prometheus</i>	Hyperion-class
NCC-866	U.S.S. <i>Triton</i>	Hyperion-class
NCC-867	U.S.S. <i>Sebastian</i>	Hyperion-class
NCC-868	U.S.S. <i>Miranda</i>	Hyperion-class
NCC-869	U.S.S. <i>Bellerophon</i>	Hyperion-class
NCC-870	U.S.S. <i>Naze</i>	
	U.S.S. <i>Perseus</i>	Hyperion-class
NCC-871	U.S.S. <i>Apollo</i>	Hyperion-class
NCC-872	U.S.S. <i>Pacatrix</i>	Hyperion-class
	The <i>Pacatrix</i> saw extensive service as a long-range explorer both inside and outside Federation space, is now on display at the Starfleet Museum.	
NCC-873	U.S.S. <i>Cronus</i>	Hyperion-class
NCC-874	U.S.S. <i>Mimas</i>	Hyperion-class
NCC-875	U.S.S. <i>Achilles</i>	Hyperion-class
NCC-876	U.S.S. <i>Las Vegas</i>	Lincoln-class
NCC-882	U.S.S. <i>Paris</i>	Paris-class

Launched in 2196, the first starship of her class. 129.6m long, 75.5m wide and 22m high, the ship had a crew compliment of 93 and a displacement of 30,100 metric tones.

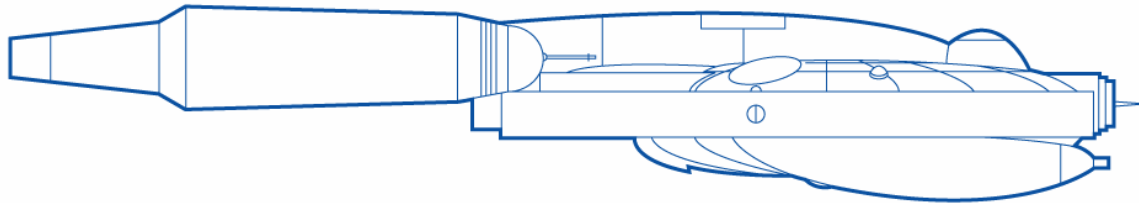

NCC-883	U.S.S. <i>Berlin</i>	Paris-class
NCC-884	U.S.S. <i>Madrid</i>	Paris-class
NCC-885	U.S.S. <i>Amsterdam</i>	Paris-class
NCC-886	U.S.S. <i>Roma</i>	Paris-class
NCC-887	U.S.S. <i>Praha</i>	Paris-class
NCC-888	U.S.S. <i>Lisboa</i>	Paris-class
NCC-889	U.S.S. <i>Oslo</i>	Paris-class
NCC-890	U.S.S. <i>Kiev</i>	Paris-class
NCC-891	U.S.S. <i>Bratislava</i>	Paris-class
NCC-892	U.S.S. <i>New York</i>	Paris-class
NCC-893	U.S.S. <i>Houston</i>	Paris-class
NCC-894	U.S.S. <i>Chicago</i>	Paris-class
	U.S.S. <i>Ulysses</i>	
NCC-895	U.S.S. <i>Miami</i>	Paris-class
NCC-896	U.S.S. <i>Toronto</i>	Paris-class
NCC-897	U.S.S. <i>Mojave</i>	Paris-class
	U.S.S. <i>Sumatra</i>	

NCC-898	U.S.S. <i>Havana</i>	Paris-class
NCC-899	U.S.S. <i>Rio de Janeiro</i>	Paris-class
NCC-900	U.S.S. <i>Fisher</i>	Fisher-class
	First starship of her class, classified as a light transport/tug vessel.	
	U.S.S. <i>Texas</i>	Texas-class
	Prototype of her class, a light cruiser. 336.2m long and 171.2m wide.	

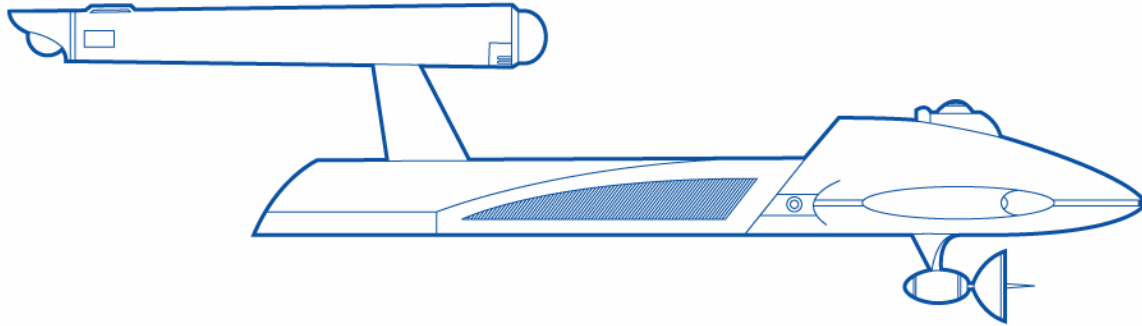

	U.S.S. <i>Santiago</i>	Paris-class
NCC-901	U.S.S. <i>Carolina</i>	
	Light cruiser with a crew compliment of 367. At one time the ship was commanded by Captain Nakamura.	
	U.S.S. <i>Adabi</i>	Fisher-class
	U.S.S. <i>Sao Paulo</i>	Paris-class
	U.S.S. <i>Atlas</i>	
NCC-902	U.S.S. <i>Kashmir</i>	
	Light cruiser with a crew compliment of 367.	
	U.S.S. <i>Esher</i>	Fisher-class
	U.S.S. <i>Tripoli</i>	Paris-class
	U.S.S. <i>Snowden</i>	
NCC-903	U.S.S. <i>Wales</i>	
	Light cruiser with a crew compliment of 367.	
	U.S.S. <i>Hamsteir</i>	Fisher-class
	U.S.S. <i>Lagos</i>	Paris-class
NCC-904	U.S.S. <i>Zaire</i>	
	Minesweeper with a crew compliment of 367	
	U.S.S. <i>Bellamy</i>	Fisher-class
	U.S.S. <i>Nairobi</i>	Paris-class
NCC-905	U.S.S. <i>Bavaria</i>	
	Light cruiser with a crew compliment of 367	
	U.S.S. <i>Goza</i>	Fisher-class
	U.S.S. <i>Progress</i>	Lincoln-class
	U.S.S. <i>Dar es Salaam</i>	Paris-class
NCC-906	U.S.S. <i>Lorraine</i>	
	Light cruiser with a crew compliment of 367.	
	U.S.S. <i>Woodworth</i>	Fisher-class
	U.S.S. <i>Soyuz</i>	Lincoln-class
	U.S.S. <i>Karachi</i>	Paris-class

NCC-907	U.S.S. <i>Valencia</i> Minesweeper with a crew compliment of 367.	
	U.S.S. <i>Slauson</i>	Fisher-class
	U.S.S. <i>Delhi</i>	Paris-class
NCC-908	U.S.S. <i>Whittaker</i>	Fisher-class
	U.S.S. <i>Teheran</i>	Paris-class
NCC-909	U.S.S. <i>Tyrol</i> Minesweeper with a crew compliment of 367.	
	U.S.S. <i>Baghdad</i>	Paris-class
	U.S.S. <i>Hodges</i>	
NCC-910	U.S.S. <i>Damascus</i>	Paris-class
	Starship that was a participant in battles at Garner 441, Bisei-Shinnihon G, and Lisyk VIII, became a display at the Starfleet Museum.	
	U.S.S. <i>Bansiya</i>	
	U.S.S. <i>Scotland</i>	Lincoln-class
NCC-911	U.S.S. <i>Muscovy</i> Starship later renamed U.S.S. <i>Koniev</i> and re-registered as NCC-961.	
	U.S.S. <i>Sarver</i>	Fisher-class
	U.S.S. <i>Merlin</i>	Lincoln-class
	U.S.S. <i>Amman</i>	Paris-class
NCC-912	U.S.S. <i>Sinai</i> Starship later renamed U.S.S. <i>Viking</i> and re-registered as NCC-962.	
	U.S.S. <i>Morphield</i>	Fisher-class
	U.S.S. <i>Jerusalem</i>	Paris-class
NCC-913	U.S.S. <i>Pape</i>	Fisher-class
	U.S.S. <i>Kabul</i>	Paris-class
	U.S.S. <i>Alpha Centauri</i>	
NCC-914	U.S.S. <i>Bangkok</i>	Paris-class
	U.S.S. <i>Gainies</i>	
NCC-915	U.S.S. <i>Reliance</i>	Reliance-class
	First vessel of the class, classified as a superscout.	
	U.S.S. <i>California</i> Starship later renamed U.S.S. <i>Patton</i> and re-registered as NCC-965.	
	U.S.S. <i>Seoul</i>	Paris-class
	U.S.S. <i>Cumbie</i>	
NCC-916	U.S.S. <i>Isfahan</i> Minesweeper with a crew of 367.	
	U.S.S. <i>Wentworth</i>	Fisher-class
	U.S.S. <i>Shanghai</i>	Paris-class
NCC-917	U.S.S. <i>Zana</i>	Fisher-class
	U.S.S. <i>Beijing</i>	Paris-class
NCC-918	U.S.S. <i>Crus</i>	Fisher-class
	U.S.S. <i>Manila</i>	Paris-class
NCC-919	U.S.S. <i>Pajunen</i>	Fisher-class
	U.S.S. <i>Tycho City</i>	Paris-class

NCC-920	U.S.S. <i>Jahor</i> Minesweeper with a crew of 367.	
	U.S.S. <i>Yates</i>	Fisher-class
	U.S.S. <i>Port Lowell</i>	Paris-class
	The last ship of her class to be withdrawn from service, in 2261.	
NCC-921	U.S.S. <i>Pendergrass</i>	Fisher-class
	U.S.S. <i>Cosmograd</i>	Paris-class
NCC-922	U.S.S. <i>Hooten</i>	Fisher-class
NCC-923	U.S.S. <i>Galaboff</i>	
NCC-924	U.S.S. <i>Alaska</i> Starship that was later redesignated NCC-974, U.S.S. <i>Voyager</i> .	
	U.S.S. <i>Windgate</i>	
NCC-925	U.S.S. <i>Augustus</i>	Fisher-class
NCC-926	U.S.S. <i>Stubno</i>	Fisher-class
NCC-927	U.S.S. <i>Palaoro</i>	Fisher-class
NCC-928	U.S.S. <i>Hubert</i>	Fisher-class
NCC-929	U.S.S. <i>Durbin</i>	Fisher-class
NCC-930	U.S.S. <i>O'lynn</i>	Fisher-class
NCC-931	U.S.S. <i>Shook</i>	Fisher-class
NCC-932	U.S.S. <i>Crone</i>	Fisher-class
NCC-933	U.S.S. <i>Normandy</i> Commando cruiser with a compliment of 367.	
	U.S.S. <i>Archibald</i>	Fisher-class
NCC-934	U.S.S. <i>Fehlandet</i>	Fisher-class
NCC-935	U.S.S. <i>Martinck</i>	Fisher-class
NCC-936	U.S.S. <i>Chernigoy</i>	Auckland-class
	Cruiser, the seventh ship of her class. It was built at the Biraktes shipyards.	
	U.S.S. <i>Remy</i>	Fisher-class
NCC-937	U.S.S. <i>Chien</i>	Fisher-class
NCC-938	U.S.S. <i>Okinawa</i> Commando cruiser with a crew of 367.	
	U.S.S. <i>Whitlock</i>	Fisher-class
NCC-939	U.S.S. <i>Gallipoli</i> Commando cruiser with a crew of 367.	
	U.S.S. <i>Cobb</i>	Fisher-class
NCC-940	U.S.S. <i>Quebec</i> Commando cruiser with a crew of 367.	
	U.S.S. <i>Patrick</i>	
	U.S.S. <i>Hornet</i>	
NCC-941	U.S.S. <i>Adamus</i>	
NCC-942	U.S.S. <i>Hoing</i>	Fisher-class
NCC-943	U.S.S. <i>Bainsworth</i>	Fisher-class
NCC-944	U.S.S. <i>Queenney</i>	Fisher-class

NCC-945

U.S.S. *Asia*

Asia-class

First vessel of her class, weighing in at 157,000 metric tones. 225.1m long, 99m wide and 55m high. The ship had a compliment of 280 and a top rated speed of warp 5.1.

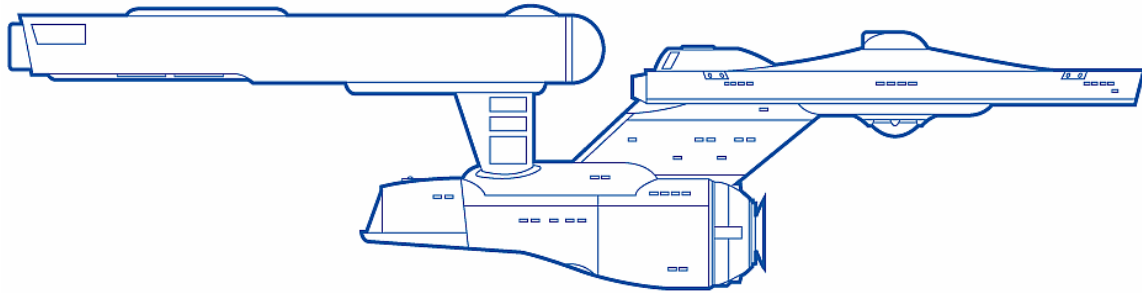

U.S.S. *Oklahoma*

Light cruiser.

U.S.S. *Prestguard*

Fisher-class

NCC-946

U.S.S. *Barclay*

Fisher-class

NCC-947

U.S.S. *Trefethen*

Fisher-class

NCC-948

U.S.S. *Refuge*

Hospital ship that was converted from a light cruiser.

U.S.S. *Fears*

Fisher-class

NCC-949

U.S.S. *Sanctuary*

Hospital ship that was converted from a light cruiser.

U.S.S. *Nease*

Fisher-class

NCC-950

U.S.S. *Tumlin*

Fisher-class

NCC-951

U.S.S. *Newter*

NCC-952

U.S.S. *Deanda*

Fisher-class

NCC-953

U.S.S. *Brazil*

Fisher-class

NCC-954

U.S.S. *Rawlins*

Fisher-class

NCC-955

U.S.S. *Joiner*

Fisher-class

NCC-956

U.S.S. *Eagle*

Constitution-class

James T. Kirk once served as First Officer of this vessel early in his Starfleet career. The ship was on a colony resupply mission on stardate 9521.

U.S.S. *Flannery*

Fisher-class

NCC-957

U.S.S. *Givens*

Fisher-class

NCC-958

U.S.S. *Porfillio*

Fisher-class

NCC-959

U.S.S. *Usselkar*

Fisher-class

NCC-960

U.S.S. *Rajnar*

Fisher-class

NCC-961

U.S.S. *Koniev*

Escort cruiser with a crew compliment of 367. It was assigned escort duty to the U.S.S. *Zhukov* NCC-2202, and had originally bore the name U.S.S. *Muscovy* and bore the registry number of NCC-911.

U.S.S. *Turri*

Fisher-class

NCC-962

U.S.S. *Viking*

Light survey cruiser with a crew compliment of 367. It originally bore the name U.S.S. *Sinai* and bore the registry number of NCC-912.

U.S.S. *Vandergriff*

Fisher-class

NCC-963

U.S.S. *Hurst*

Fisher-class

NCC-964

U.S.S. *Yeager*

NCC-965	U.S.S. <i>Patton</i> Escort cruiser with a crew compliment of 367. It was assigned escort duty to the U.S.S. <i>MacArthur</i> NCC-2201, and had originally bore the name U.S.S. <i>California</i> and bore the registry number of NCC-915.	
	U.S.S. <i>Lochard</i>	Fisher-class
NCC-966	U.S.S. <i>Orleans</i> Participant in the Battle of Donatu V in 2242. From 2254-56 it served as a testbed for phaser experiments.	Ranger-class
	U.S.S. <i>Edgar</i>	
NCC-967	U.S.S. <i>Hastings</i>	Fisher-class
NCC-968	U.S.S. <i>Fohner</i>	Fisher-class
NCC-969	U.S.S. <i>Allan</i>	Fisher-class
NCC-970	U.S.S. <i>Staker</i>	Fisher-class
NCC-971	U.S.S. <i>Barabus</i>	Fisher-class
NCC-972	U.S.S. <i>Jurenko</i>	Fisher-class
NCC-973	U.S.S. <i>Stover</i>	Fisher-class
NCC-974	U.S.S. <i>Voyager</i> Light survey cruiser with a crew of 367. This vessel was originally designated U.S.S. <i>Alaska</i> NCC-924.	
	U.S.S. <i>Bobbets</i>	Fisher-class
NCC-975	U.S.S. <i>Ingrad</i>	Fisher-class
NCC-976	U.S.S. <i>Sandwell</i>	Fisher-class
NCC-977	U.S.S. <i>Achatz</i>	Fisher-class
NCC-978	U.S.S. <i>Curvin</i>	Fisher-class
NCC-979	U.S.S. <i>Kennis</i>	Fisher-class
NCC-980	U.S.S. <i>Pinevale</i> U.S.S. <i>Atrius</i>	
NCC-981	U.S.S. <i>Meeford</i>	Fisher-class
NCC-982	U.S.S. <i>Sal'koth</i> Starship that captured the I.K.S. <i>Dit'kra</i> in 2239, providing Starfleet with an unheard of look at Klingon tech.	Ranger-class
	U.S.S. <i>Stoltz</i>	Fisher-class
NCC-983	U.S.S. <i>Wilheight</i>	Fisher-class
NCC-984	U.S.S. <i>Curtin</i>	Fisher-class
NCC-985	U.S.S. <i>Shaunessey</i>	Fisher-class
NCC-986	U.S.S. <i>Patience</i> U.S.S. <i>Farragut</i>	Fisher-class
NCC-987	U.S.S. <i>Tippewa</i>	
NCC-988	U.S.S. <i>O'brien</i>	Fisher-class
NCC-989	U.S.S. <i>Tenderall</i>	Fisher-class
NCC-990	U.S.S. <i>Madigan</i>	Fisher-class
NCC-991	U.S.S. <i>America</i> U.S.S. <i>Vincent</i>	Asia-class
NCC-992	U.S.S. <i>Wagner</i>	

NCC-1000	U.S.S. <i>Horizon</i>	Horizon-class
	First vessel of her class, designated a cruiser.	
	U.S.S. <i>Carolina</i>	Ranger-class
	Starship that made first contact with the gan'Teth in 2219. It destroyed four Klingon ships in the 2233 Battle of the Yosaan Cloud.	
NCC-1001	U.S.S. <i>Endeavour</i>	Constitution-class
	Lost in 2250 in the Theta Eridani star system.	
	U.S.S. <i>Discovery</i>	Horizon-class
	U.S.S. <i>Odyser</i>	
NCC-1001-A	U.S.S. <i>Odyser</i>	
	The second starship to bear the name, the <i>Odyser</i> remained in service well into the 24 th Century as a Starfleet Academy training vessel.	
NCC-1002	U.S.S. <i>Santa Maria</i>	Horizon-class
	U.S.S. <i>Africa</i>	Asia-class
NCC-1003	U.S.S. <i>Mathew</i>	Horizon-class
	U.S.S. <i>Europe</i>	Asia-class
NCC-1004	U.S.S. <i>Gauss</i>	Horizon-class
	U.S.S. <i>Australia</i>	Asia-class
NCC-1005	U.S.S. <i>Zephyr</i>	Miranda-class
	Vessel commanded by Captain Phil Burroughs, it was commandeered in 2291 by Garth of Izar and used to wreak havoc on the Klingon Empire, nearly starting an interstellar war.	
	U.S.S. <i>San Raphael</i>	Horizon-class
NCC-1006	U.S.S. <i>Scotia</i>	Horizon-class
NCC-1007	U.S.S. <i>Nimrod</i>	Horizon-class
NCC-1010	U.S.S. <i>Akyazi</i>	Akyazi-class
	Prototype vessel of her class, designated a perimeter action ship.	



NCC-1011	U.S.S. <i>Atsura</i>	Akyazi-class
	U.S.S. <i>Norge</i>	Horizon-class
NCC-1012	U.S.S. <i>Akitsu</i>	Akyazi-class
	U.S.S. <i>Meteor</i>	Horizon-class
NCC-1013	U.S.S. <i>Braga</i>	Akyazi-class
	U.S.S. <i>Victoria</i>	Horizon-class
NCC-1014	U.S.S. <i>Ameer</i>	Akyazi-class
	U.S.S. <i>Golden Hind</i>	Horizon-class
NCC-1015	U.S.S. <i>Epirus</i>	Akyazi-class
NCC-1016	U.S.S. <i>Amagi</i>	Akyazi-class
	U.S.S. <i>Half Moon</i>	Horizon-class

NCC-1017	U.S.S. <i>Constellation</i>	Constitution-class
	One of the original 12 Constitution-class ships, it was destroyed in 2267 near system L-374 by an extra-galactic 'planet killer' later learned to be a defense against the Borg. At the time of its destruction, the ship was under the command of Commodore Matthew Decker. At one time, the ship had been commanded by Captain Ronald Armstrong.	
	U.S.S. <i>Abreus</i>	Akyazi-class
NCC-1018	U.S.S. <i>Eleusis</i>	Akyazi-class
	U.S.S. <i>Eendracht</i>	Horizon-class
	U.S.S. <i>Goeben</i>	Constitution-class
NCC-1019	U.S.S. <i>Alten</i>	Alten-class
	First ship of her class, designated by Starfleet as a perimeter action vessel.	
NCC-1020	U.S.S. <i>Guam</i>	Guam-class
	Prototype vessel of her class, designated a though-deck carrier vessel. Crewed by 390 people, it weighed 220,000 metric tonnes. Designed to deliver two complete squadrons (of 25 each) of Tomahawk attack-craft to any arena, and then to serve as a support vessel after. Armed with seven dual phaser banks and two torpedo launchers, the <i>Guam</i> was 304.8m long, 141.7m wide and 81.6m high.	
	U.S.S. <i>Bucke</i>	Akyazi-class
	A perimeter action vessel.	
	U.S.S. <i>Discovery</i>	
	A galactic survey cruiser with a crew of 451.	
	U.S.S. <i>Oriskony</i>	Constitution-class
NCC-1021	U.S.S. <i>Bengal</i>	Akyazi-class
NCC-1022	U.S.S. <i>Biisk</i>	Akyazi-class
NCC-1023	U.S.S. <i>Ephesus</i>	Akyazi-class
	U.S.S. <i>Bolland</i>	Miranda-class
NCC-1024	U.S.S. <i>Whorfin</i>	
	Deep-space exploration vessel that on stardate 9521 was on Neutral Zone patrol.	
	U.S.S. <i>Ermont</i>	
NCC-1025	U.S.S. <i>Acavus</i>	Akyazi-class
NCC-1026	U.S.S. <i>Beuel</i>	Akyazi-class
NCC-1027	U.S.S. <i>Buran</i>	Akyazi-class
NCC-1028	U.S.S. <i>Atuga</i>	Akyazi-class
NCC-1029	U.S.S. <i>Arauca</i>	Akyazi-class
NCC-1030	U.S.S. <i>Araxes</i>	Akyazi-class
NCC-1031	U.S.S. <i>Eiger</i>	Akyazi-class
NCC-1032	U.S.S. <i>Ebro</i>	Akyazi-class
NCC-1033	U.S.S. <i>Brant</i>	Akyazi-class
NCC-1034	U.S.S. <i>Avesta</i>	Akyazi-class
NCC-1035	U.S.S. <i>Explorer</i>	Ranger-class
	Lost in the Theta Reticula system in 2233.	
	U.S.S. <i>Accipiter</i>	Akyazi-class
NCC-1036	U.S.S. <i>Bril</i>	Akyazi-class
NCC-1037	U.S.S. <i>Bisbee</i>	Akyazi-class
NCC-1038	U.S.S. <i>Akita</i>	Akyazi-class
NCC-1039	U.S.S. <i>Acri</i>	Akyazi-class
NCC-1040	U.S.S. <i>Bendraze</i>	Akyazi-class

NCC-1041	U.S.S. <i>Eire</i>	Akyazi-class
NCC-1042	U.S.S. <i>Echo</i>	Akyazi-class
NCC-1043	U.S.S. <i>Evian</i>	Akyazi-class
NCC-1044	U.S.S. <i>Abila</i>	Akyazi-class
NCC-1045	U.S.S. <i>Ancylus</i>	Akyazi-class
NCC-1046	U.S.S. <i>Amastra</i>	Akyazi-class
NCC-1047	U.S.S. <i>Accra</i>	Akyazi-class
NCC-1048	U.S.S. <i>Arbiter</i>	Arbiter-class
	First vessel of her class, classified by the Fleet as a perimeter action vessel.	
NCC-1049	U.S.S. <i>Acerra</i>	Arbiter-class
NCC-1050	U.S.S. <i>Juist</i>	Arbiter-class
	U.S.S. <i>Alert</i>	Alert-class
	First vessel of her class, a perimeter action vessel.	

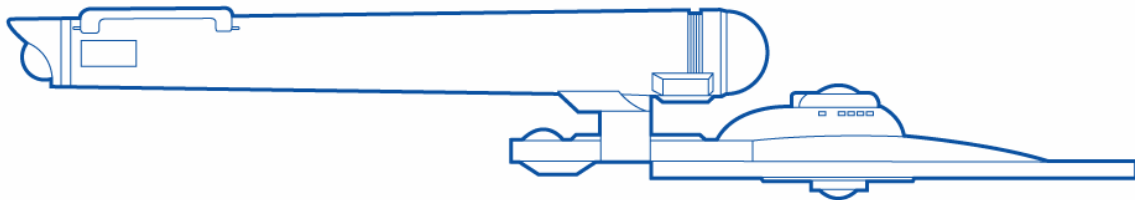

NCC-1051	U.S.S. <i>Arashi</i>	Arbiter-class
NCC-1052	U.S.S. <i>Atago</i>	Arbiter-class
	U.S.S. <i>Phalarope</i>	Alert-class
NCC-1053	U.S.S. <i>Apia</i>	Arbiter-class
NCC-1054	U.S.S. <i>Tensas</i>	Arbiter-class
NCC-1055	U.S.S. <i>Thun</i>	Arbiter-class
	U.S.S. <i>Surprise</i>	Alert-class
NCC-1056	U.S.S. <i>Atessa</i>	Arbiter-class
NCC-1057	U.S.S. <i>Jico</i>	Arbiter-class
NCC-1058	U.S.S. <i>Jari</i>	Arbiter-class
NCC-1059	U.S.S. <i>Armavir</i>	Arbiter-class
NCC-1060	U.S.S. <i>Artika</i>	Arbiter-class
NCC-1061	U.S.S. <i>Jelai</i>	Arbiter-class
NCC-1062	U.S.S. <i>Talence</i>	Arbiter-class
NCC-1063	U.S.S. <i>Tioga</i>	Arbiter-class
NCC-1064	U.S.S. <i>Thrace</i>	Arbiter-class
NCC-1065	U.S.S. <i>Julin</i>	Arbiter-class
NCC-1066	U.S.S. <i>Tachira</i>	Arbiter-class
NCC-1067	U.S.S. <i>Almdes</i>	Arbiter-class
NCC-1068	U.S.S. <i>Abitibi</i>	Arbiter-class
NCC-1069	U.S.S. <i>Archer</i>	Arbiter-class
NCC-1070	U.S.S. <i>Aversa</i>	Arbiter-class
NCC-1071	U.S.S. <i>Jativa</i>	Arbiter-class
NCC-1072	U.S.S. <i>Jersey</i>	Arbiter-class
NCC-1073	U.S.S. <i>Jefferson</i>	Asia-class
	U.S.S. <i>Tuira</i>	Arbiter-class
NCC-1074	U.S.S. <i>Azusa</i>	Arbiter-class
	U.S.S. <i>Manhattan</i>	Asia-class

NCC-1075	U.S.S. <i>Clarion</i> This ship was eventually retired from active Starfleet duty.	Constitution-class
	U.S.S. <i>Trigarta</i>	Arbiter-class
NCC-1076	U.S.S. <i>Arques</i>	Arbiter-class
NCC-1077	U.S.S. <i>Aparri</i>	Arbiter-class
NCC-1078	U.S.S. <i>Argus</i>	Arbiter-class
NCC-1079	U.S.S. <i>Tanaga</i>	Arbiter-class
NCC-1080	U.S.S. <i>Timis</i>	Arbiter-class
NCC-1081	U.S.S. <i>Alava</i>	Arbiter-class
NCC-1082	U.S.S. <i>Agtekerk</i>	Arbiter-class
NCC-1083	U.S.S. <i>Ashiya</i>	Arbiter-class
NCC-1084	U.S.S. <i>Jaro</i>	Arbiter-class
NCC-1085	U.S.S. <i>Manhattan</i>	Asia-class
	U.S.S. <i>Tinian</i>	Arbiter-class
NCC-1086	U.S.S. <i>Antibes</i>	Arbiter-class
NCC-1087	U.S.S. <i>Arban</i>	Arbiter-class
NCC-1088	U.S.S. <i>Apure</i>	Arbiter-class
NCC-1089	U.S.S. <i>Aulon</i>	Arbiter-class
NCC-1090	U.S.S. <i>Kruger</i> First starship of her class, designated a superscout.	Kruger-class
	U.S.S. <i>Akula</i> First vessel of her class, a perimeter action ship.	Akula-class
NCC-1091	U.S.S. <i>Kitkun</i>	Akula-class
NCC-1092	U.S.S. <i>Athy</i>	Akula-class
NCC-1093	U.S.S. <i>Arvika</i>	Akula-class
NCC-1094	U.S.S. <i>Kuril</i>	Akula-class
NCC-1095	U.S.S. <i>Atami</i>	Akula-class
NCC-1096	U.S.S. <i>Saros</i>	Akula-class
NCC-1097	U.S.S. <i>Avaricum</i>	Akula-class
NCC-1098	U.S.S. <i>Sjoto</i>	Akula-class
NCC-1099	U.S.S. <i>Sandusky</i>	Akula-class
NCC-1100	U.S.S. <i>Detroyat</i> First starship of her class, classified by the Fleet as a heavy destroyer.	Detroyat-class

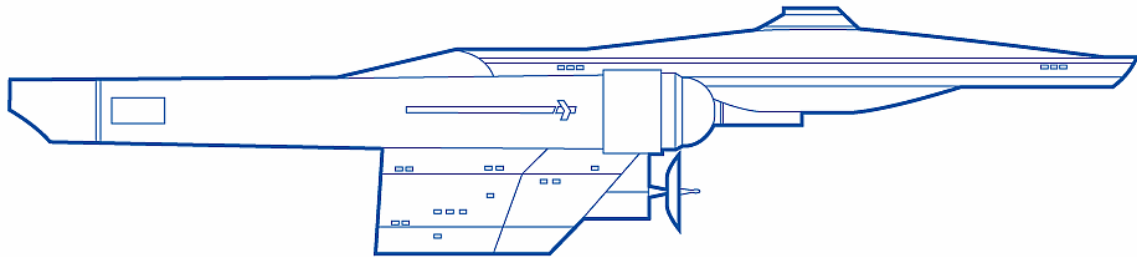

	U.S.S. <i>Kern</i> A perimeter action vessel.	
NCC-1101	U.S.S. <i>Resolution</i>	Detroyat-class
	U.S.S. <i>Atyra</i> A perimeter action ship.	

NCC-1102	U.S.S. <i>Miramar</i> U.S.S. <i>Sybaris</i> A perimeter action vessel.	
NCC-1103	U.S.S. <i>Troden</i> U.S.S. <i>Kuei</i> A perimeter action vessel.	Detroyat-class
NCC-1104	U.S.S. <i>Breckenridge</i> U.S.S. <i>Krka</i> A perimeter action ship.	Detroyat-class
NCC-1105	U.S.S. <i>Yukon</i> U.S.S. <i>Niantic</i> Believed lost to the same “planet killer” that claimed the U.S.S. <i>Constellation</i> NCC-1017 at system M-370. U.S.S. <i>Akuri</i> A perimeter action vessel.	Asia-class Detroyat-class
NCC-1106	U.S.S. <i>Thule</i> U.S.S. <i>Warangal</i> U.S.S. <i>Shirante</i> A perimeter action vessel.	Asia-class Detroyat-class
NCC-1107	U.S.S. <i>Commanger</i> U.S.S. <i>Samakov</i> A perimeter action vessel.	Detroyat-class
NCC-1108	U.S.S. <i>Strathclair</i> U.S.S. <i>Sitka</i> A perimeter action vessel.	Detroyat-class
NCC-1109	U.S.S. <i>Donar</i> U.S.S. <i>Ajanta</i> A perimeter action vessel.	Detroyat-class
NCC-1110	U.S.S. <i>Kalinin</i>	Detroyat-class
NCC-1111	U.S.S. <i>Kutaisi</i>	Detroyat-class
NCC-1112	U.S.S. <i>Sangamon</i>	Detroyat-class
NCC-1113	U.S.S. <i>Kelkit</i>	Detroyat-class
NCC-1114	U.S.S. <i>Anaiza</i>	Detroyat-class
NCC-1119	U.S.S. <i>Eclipse</i>	Eclipse-class

Light cruiser, the first vessel of her class. Launched in 2211, the ship was crewed by 220 persons. The ship was 169m long, 99m wide and 45m high.

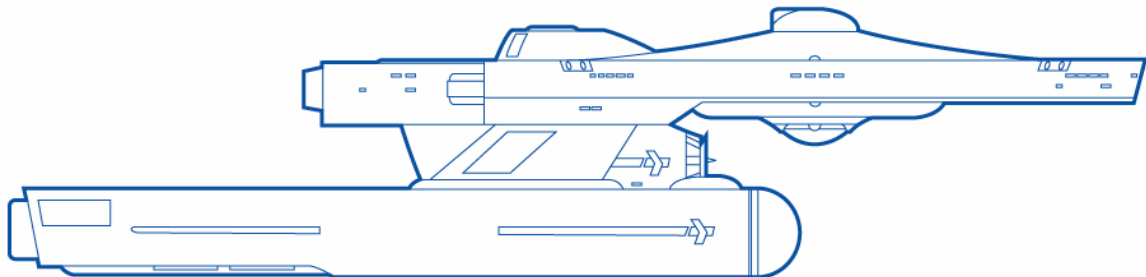

NCC-1120	U.S.S. <i>Panama</i>	Eclipse-class
NCC-1125	U.S.S. <i>Engage</i> First vessel of her class, classified as a perimeter action vessel.	Engage-class
NCC-1129	U.S.S. <i>Enfield</i>	Engage-class

NCC-1132	U.S.S. <i>Ortzi</i>	Palomino-class	Light cruiser commissioned in 2209. The vessel later served as a freighter near the Romulan Neutral Zone.
NCC-1145	U.S.S. <i>Caesar Augustus</i>	Caesar-class	First vessel of her class, a heavy cruiser. It was built at the Utopia Planitia Fleet Yards at Mars. It had 38 decks and was crewed by 940 persons.
NCC-1170	U.S.S. <i>Kirsanov</i>	Kirsanov-class	First ship of her class, a large perimeter action vessel.
NCC-1171	U.S.S. <i>Kitimat</i>	Kirsanov-class	
NCC-1176	U.S.S. <i>Excalibur</i>		
NCC-1199	U.S.S. <i>Massachusetts</i>		
NCC-1199-A	U.S.S. <i>Massachusetts</i>		
NCC-1199-B	U.S.S. <i>Massachusetts</i>		
NCC-1199-C	U.S.S. <i>Massachusetts</i>		
NCC-1199-D	U.S.S. <i>Massachusetts</i>	Nebula-class	
NCC-1200	U.S.S. <i>Advance</i>	Advance-class	First vessel of her class, designated a cruiser.
	U.S.S. <i>Brenton</i>	Brenton-class	Prototype "space-tank" vessel.
NCC-1209	U.S.S. <i>Lancaster</i>	Lancaster-class	First starship of her class, it was 227.26m long, with a crew of 310. The ship weighed 145,020 metric tones and had a maximum rated speed of warp factor 5.8.
NCC-1210	U.S.S. <i>Merkwurdigliebe</i>	Lancaster-class	
NCC-1211	U.S.S. <i>Ticonderoga</i>	Lancaster-class	
NCC-1212	U.S.S. <i>Poole</i>	Lancaster-class	
NCC-1213	U.S.S. <i>Colossus</i>	Lancaster-class	
NCC-1214	U.S.S. <i>Invincible</i>	Lancaster-class	
NCC-1215	U.S.S. <i>Ceres</i>	Lancaster-class	
NCC-1216	U.S.S. <i>Olympia</i>	Lancaster-class	
NCC-1217	U.S.S. <i>Wolfe</i>	Lancaster-class	
NCC-1218	U.S.S. <i>The Traceys</i>	Lancaster-class	
NCC-1219	U.S.S. <i>Mustang</i>	Lancaster-class	
NCC-1220	U.S.S. <i>Person</i>	Lancaster-class	
NCC-1221	U.S.S. <i>Haldeman</i>	Lancaster-class	
NCC-1222	U.S.S. <i>Giraud</i>	Lancaster-class	
NCC-1223	U.S.S. <i>Valiant</i>	Ranger-class	Cruiser destroyed at planet Eminiar VII in 2217 when it was declared a casualty in a computerized war between Eminiar and Vendikar.
NCC-1224	U.S.S. <i>Capek</i>	Lancaster-class	
NCC-1225	U.S.S. <i>Antitam</i>	Lancaster-class	
	U.S.S. <i>Sevastopol</i>		
NCC-1226	U.S.S. <i>Eisenhower</i>	Lancaster-class	
NCC-1227	U.S.S. <i>Whittle</i>	Lancaster-class	
NCC-1228	U.S.S. <i>Alexander Nevsky</i>	Lancaster-class	
NCC-1229	U.S.S. <i>Thunderbolt</i>	Lancaster-class	
NCC-1230	U.S.S. <i>Coventry</i>	Coventry-class	First vessel of her class, a frigate.
	U.S.S. <i>Ursus</i>	Lancaster-class	

NCC-1231	U.S.S. <i>Aristarchus</i>	Lancaster-class
	U.S.S. <i>Socorro</i>	Coventry-class
NCC-1232	U.S.S. <i>Hector</i>	Lancaster-class
	U.S.S. <i>Santander</i>	Coventry-class
NCC-1233	U.S.S. <i>Frantsa Iosifa</i>	Lancaster-class
	U.S.S. <i>Assurance</i>	Coventry-class
NCC-1234	U.S.S. <i>Unicorn</i>	Lancaster-class
	The last starship of her class to be retired from service (in 2264), it was put on permanent display at the Starfleet Museum.	
	U.S.S. <i>Dahlgren</i>	Coventry-class
NCC-1235	U.S.S. <i>Chafee</i>	Lancaster-class
	U.S.S. <i>Jen Miri</i>	Coventry-class
NCC-1236	U.S.S. <i>Lindbergh</i>	Lancaster-class
	U.S.S. <i>Constant</i>	Coventry-class
NCC-1237	U.S.S. <i>Kosciuszko</i>	Lancaster-class
	U.S.S. <i>Ashanti</i>	Ashanti-class
	First starship of her class.	
NCC-1238	U.S.S. <i>Jakarta</i>	Lancaster-class
	U.S.S. <i>Sverdlov</i>	Coventry-class
NCC-1239	U.S.S. <i>Korya</i>	Lancaster-class
	U.S.S. <i>Eltanin</i>	Coventry-class
NCC-1240	U.S.S. <i>Venkkman</i>	Lancaster-class
	U.S.S. <i>Resurgent</i>	Coventry-class
NCC-1241	U.S.S. <i>Auriga</i>	Coventry-class
	U.S.S. <i>London</i>	Lancaster-class
NCC-1242	U.S.S. <i>Burroughs</i>	Lancaster-class
	U.S.S. <i>Carriacou</i>	Coventry-class
NCC-1243	U.S.S. <i>Indus</i>	Coventry-class
	U.S.S. <i>Illustrious</i>	Lancaster-class
NCC-1243-A	U.S.S. <i>Indus</i>	
NCC-1243-B	U.S.S. <i>Indus</i>	MacPherson class
	A heavy transport vessel.	
NCC-1244	U.S.S. <i>Oppenheimer</i>	Lancaster-class
NCC-1245	U.S.S. <i>Phoenix</i>	Lancaster-class
NCC-1246	U.S.S. <i>Chandrasekhar</i>	Lancaster-class
NCC-1247	U.S.S. <i>Neptune</i>	Lancaster-class
NCC-1248	U.S.S. <i>Przhevalsky</i>	Lancaster-class
NCC-1249	U.S.S. <i>Singapore</i>	Lancaster-class
NCC-1250	U.S.S. <i>Arronax</i>	Lancaster-class
NCC-1251	U.S.S. <i>Alfred T Mahan</i>	Lancaster-class
NCC-1252	U.S.S. <i>Texas</i>	Lancaster-class
NCC-1253	U.S.S. <i>Churchill</i>	Lancaster-class
NCC-1254	U.S.S. <i>Spitfire</i>	Lancaster-class
NCC-1255	U.S.S. <i>Amundsen</i>	Lancaster-class
NCC-1256	U.S.S. <i>Phantom</i>	Lancaster-class
NCC-1257	U.S.S. <i>India</i>	Lancaster-class
NCC-1258	U.S.S. <i>Spaulding</i>	Lancaster-class

NCC-1259

U.S.S. *Swordfish*

Swordfish-class

First starship of her class, designated a carrier. Displacing 132,900 tones, the ship was 189.9m long, 100.4m wide and 52.7m high. The ship had a crew compliment of 290 and was capable of carrying 16 Puffin-class fighters.

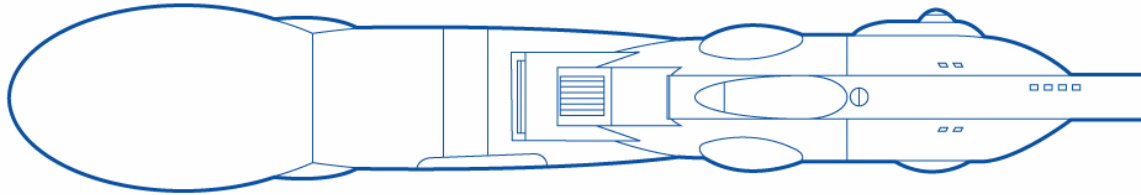

NCC-1260

U.S.S. *Barracuda*

Swordfish-class

NCC-1261

U.S.S. *Stingray*

Swordfish-class

NCC-1262

U.S.S. *Cachalot*

Swordfish-class

NCC-1263

U.S.S. *Orca*

Swordfish-class

NCC-1264

U.S.S. *Narwhal*

Swordfish-class

NCC-1265

U.S.S. *Lobster*

Swordfish-class

NCC-1266

U.S.S. *Piranha*

Swordfish-class

NCC-1267

U.S.S. *Squid*

Swordfish-class

NCC-1268

U.S.S. *Octopus*

Swordfish-class

NCC-1269

U.S.S. *Alligator*

Swordfish-class

NCC-1270

U.S.S. *Phoenix*

Eclipse-class

U.S.S. *Hammerhead*

Swordfish-class

NCC-1271

U.S.S. *Manatee*

Swordfish-class

NCC-1272

U.S.S. *Coelacanth*

Swordfish-class

Vessel that was put on display at the Starfleet Museum.

NCC-1273

U.S.S. *Carp*

Swordfish-class

NCC-1274

U.S.S. *Trilobite*

Swordfish-class

NCC-1275

U.S.S. *Grampus*

Swordfish-class

NCC-1276

U.S.S. *Sevastopol*

Eclipse-class

U.S.S. *Cuttlefish*

Swordfish-class

NCC-1277

U.S.S. *Steuben*

Eclipse-class

U.S.S. *Placoderm*

Swordfish-class

NCC-1278

U.S.S. *Cornwall*

Eclipse-class

U.S.S. *Walrus*

Swordfish-class

NCC-1279

U.S.S. *Polaris*

Eclipse-class

NCC-1280

U.S.S. *Quetzalcoatl*

Quetzalcoatl-class

First vessel of her class, classified as a semi-dreadnought. The ship was 239.2m long, 35.4m wide and 108.3m high and had a deadweight tonnage of 245,974 tones, with a crew compliment of 713.

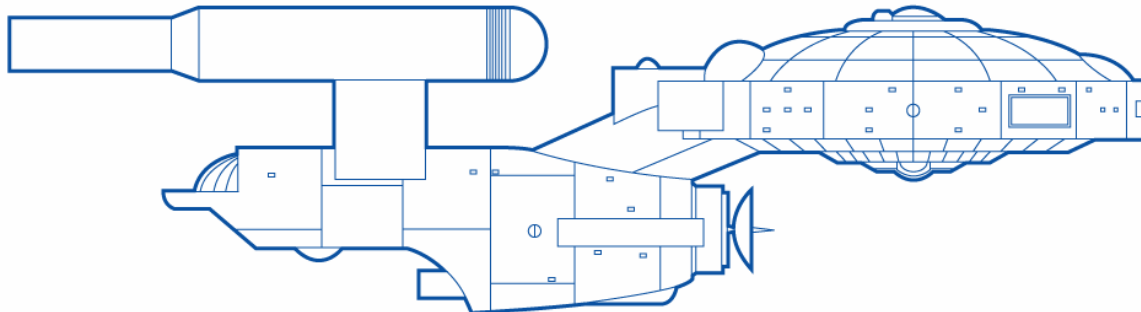

NCC-1281	U.S.S. <i>Marduk</i>	Quetzalcoatl-class
NCC-1282	U.S.S. <i>Osiris</i>	Quetzalcoatl-class
NCC-1283	U.S.S. <i>Viracocha</i>	Quetzalcoatl-class
	The last ship of the class to be withdrawn from service, was put on display at the Starfleet Museum.	
NCC-1284	U.S.S. <i>Huascar</i>	Quetzalcoatl-class
NCC-1288	U.S.S. <i>Mercury</i>	Mercury-class
	Starship, the first of her class, designated a frigate by Starfleet. The ship was launched in 2219 with a crew compliment of 179 persons. The ship was 184m long, 82m wide and 43m high.	
NCC-1296	U.S.S. <i>Bakker</i>	
	Starship destroyed on stardate 5973 at Starbase 6 by Klingon forces after a foiled robbery attempt.	
	U.S.S. <i>Arizona</i>	Mercury-class
NCC-1299	U.S.S. <i>El Paso</i>	Eclipse-class
NCC-1300	U.S.S. <i>Swiften</i>	Swiften-class
	Pathfinder vessel of her class, a fast destroyer.	
NCC-1301	U.S.S. <i>Saunders</i>	Swiften-class
NCC-1302	U.S.S. <i>Pascha</i>	Swiften-class
NCC-1303	U.S.S. <i>Edstroum</i>	Swiften-class
NCC-1304	U.S.S. <i>Houston</i>	Swiften-class
NCC-1305	U.S.S. <i>Yamato</i>	
	U.S.S. <i>Bealer</i>	Swiften-class
NCC-1305-E	U.S.S. <i>Yamato</i>	Galaxy-class
	Temporary registration of the Galaxy-class vessel later reregistered as NCC-71807.	
NCC-1306	U.S.S. <i>Chub</i>	Swiften-class
NCC-1307	U.S.S. <i>Gard</i>	Swiften-class
NCC-1308	U.S.S. <i>Scheer</i>	Swiften-class
NCC-1309	U.S.S. <i>Mathias</i>	Swiften-class
NCC-1310	U.S.S. <i>Higdon</i>	Swiften-class
	U.S.S. <i>Amchitka</i>	Amchitka-class
	Prototype vessel of her class, classified by the Fleet as a light cruiser. Launched in 2292.	
NCC-1311	U.S.S. <i>Bagley</i>	Swiften-class
NCC-1312	U.S.S. <i>Eligh</i>	Swiften-class
NCC-1313	U.S.S. <i>Boyd</i>	Swiften-class
NCC-1314	U.S.S. <i>Dimbow</i>	Swiften-class
NCC-1315	U.S.S. <i>Acreman</i>	Swiften-class
NCC-1316	U.S.S. <i>Widener</i>	Swiften-class
NCC-1317	U.S.S. <i>Yokeley</i>	Swiften-class
NCC-1318	U.S.S. <i>Kauffer</i>	Swiften-class
	U.S.S. <i>Austin</i>	Austin-class superscout
	First vessel of her class, a superscout.	
NCC-1319	U.S.S. <i>Gillian</i>	Swiften-class
NCC-1320	U.S.S. <i>Reese</i>	Swiften-class
NCC-1321	U.S.S. <i>Kalavan</i>	Swiften-class
NCC-1322	U.S.S. <i>Kaitlin</i>	Swiften-class
	U.S.S. <i>Himalaya</i>	Eclipse-class

NCC-1323	U.S.S. <i>Earlz</i>	Swiften-class
NCC-1324	U.S.S. <i>Sharply</i>	Swiften-class
NCC-1325	U.S.S. <i>Pierce</i>	Swiften-class
NCC-1326	U.S.S. <i>Styce</i>	Swiften-class
NCC-1327	U.S.S. <i>Zickius</i>	Swiften-class
NCC-1328	U.S.S. <i>Olsen</i>	Swiften-class
NCC-1337	U.S.S. <i>Saturn</i>	Eclipse-class
NCC-1360	U.S.S. <i>Tristan</i>	Mercury-class
NCC-1361	U.S.S. <i>Greenwich</i>	Mercury-class
NCC-1362	U.S.S. <i>Edison</i>	Mercury-class
NCC-1370	U.S.S. <i>Archon</i>	Archon-class
	Prototype vessel of her class, a cruiser.	
NCC-1371	U.S.S. <i>Republic</i>	Constitution-class
	The first deep-space assignment of Dr. Leonard McCoy in 2253, during which time the vessel was commanded by Captain Hillios. James T. Kirk, Gary Mitchell and Benjamin Finney also served aboard this ship, circa 2250, during which time the ship was commanded by Captain Rollin Bannock. The ship remained in the Sol system as a training vessel at least until the latter half of the 24 th century.	
NCC-1372	U.S.S. <i>Independence</i>	Archon-class
	U.S.S. <i>Reshadije</i>	Constitution-class
NCC-1373	U.S.S. <i>Adventure</i>	Archon-class
	U.S.S. <i>Ramilles</i>	Constitution-class
NCC-1374	U.S.S. <i>Resolution</i>	Archon-class
NCC-1375	U.S.S. <i>Roebuck</i>	Archon-class
NCC-1376	U.S.S. <i>Southern Cross</i>	Archon-class
NCC-1386	U.S.S. <i>Izar</i>	Eclipse-class
NCC-1396	U.S.S. <i>Detroit</i>	Detroit-class
	Light cruiser, the first of her class. Launched in 2223, the ship was 184m long, 138m wide and 43m high, with a standard crew compliment of 277.	
NCC-1398	U.S.S. <i>Guarnerius</i>	Archon-class
	U.S.S. <i>Edison</i>	
NCC-1400	U.S.S. <i>Shanks</i>	Shanks-class
	First vessel of her class, a light cruiser.	
NCC-1401	U.S.S. <i>Rothwell</i>	
	U.S.S. <i>Columbia</i>	Detroit-class
NCC-1402	U.S.S. <i>Ambercrombie</i>	Shanks-class
	U.S.S. <i>Lion</i>	Detroit-class
NCC-1403	U.S.S. <i>Nurember</i>	Shanks-class
	U.S.S. <i>Maine</i>	Detroit-class
NCC-1404	U.S.S. <i>Kasey</i>	Shanks-class
	U.S.S. <i>Forrestal</i>	Detroit-class
NCC-1405	U.S.S. <i>Renfroe</i>	Shanks-class
	U.S.S. <i>Mexico</i>	Detroit-class
NCC-1406	U.S.S. <i>Dykoski</i>	Shanks-class
	U.S.S. <i>Kestrel</i>	Kestrel-class
	Starship, the first of her class, designated a light cruiser. Launched in 2223, the ship was 111.6m long, 112.4m wide and 22.1m high, with a crew compliment of 175 and a mass of 69,480 tones.	

NCC-1407	U.S.S. <i>Carlson</i>	Shanks-class
	U.S.S. <i>Falcon</i>	Kestrel-class
NCC-1408	U.S.S. <i>Berringer</i>	Shanks-class
	U.S.S. <i>Aquila</i>	Kestrel-class
NCC-1409	U.S.S. <i>Spurlane</i>	Shanks-class
	U.S.S. <i>Warhawk</i>	Kestrel-class
NCC-1410	U.S.S. <i>Olinski</i>	Shanks-class
	U.S.S. <i>Kingfisher</i>	Kestrel-class
NCC-1411	U.S.S. <i>Vargo</i>	Shanks-class
	U.S.S. <i>Caudiptyrex</i>	Kestrel-class
NCC-1412	U.S.S. <i>Wilkins</i>	Shanks-class
	U.S.S. <i>Osprey</i>	Kestrel-class
NCC-1413	U.S.S. <i>Hartley</i>	Shanks-class
	U.S.S. <i>Vulture</i>	Kestrel-class
NCC-1414	U.S.S. <i>Sloan</i>	Shanks-class
	U.S.S. <i>Pelecyornis</i>	Kestrel-class
NCC-1415	U.S.S. <i>Alzaman</i>	Shanks-class
	U.S.S. <i>Harrier</i>	Kestrel-class
NCC-1416	U.S.S. <i>Chimathi</i>	Shanks-class
	U.S.S. <i>Roc</i>	Kestrel-class
NCC-1417	U.S.S. <i>McDaid</i>	Shanks-class
	U.S.S. <i>Diornis</i>	Kestrel-class
NCC-1418	U.S.S. <i>Zupko</i>	Shanks-class
	U.S.S. <i>Harpy</i>	Kestrel-class
NCC-1419	U.S.S. <i>Hunter</i>	Shanks-class
	U.S.S. <i>Condor</i>	Kestrel-class
NCC-1420	U.S.S. <i>Olmsted</i>	Shanks-class
	U.S.S. <i>Krechet</i>	Kestrel-class
NCC-1421	U.S.S. <i>Wynn</i>	Shanks-class
	U.S.S. <i>Deinonychus</i>	Kestrel-class
NCC-1422	U.S.S. <i>Kite</i>	Kestrel-class
	U.S.S. <i>Saultry</i>	
	U.S.S. <i>Jupiter</i>	
NCC-1423	U.S.S. <i>Harski</i>	Shanks-class
	U.S.S. <i>Goshawk</i>	Kestrel-class
NCC-1424	U.S.S. <i>Pinson</i>	Shanks-class
	U.S.S. <i>Orion</i>	Mercury-class
NCC-1425	U.S.S. <i>Jetsor</i>	Shanks-class
	U.S.S. <i>California</i>	Mercury-class
NCC-1426	U.S.S. <i>Feldman</i>	Shanks-class
	U.S.S. <i>Hamlet</i>	Mercury-class
NCC-1427	U.S.S. <i>Grandstaff</i>	Shanks-class
	U.S.S. <i>Icarus</i>	Mercury-class
NCC-1428	U.S.S. <i>Olivert</i>	Shanks-class
	U.S.S. <i>Darwin</i>	Mercury-class

NCC-1429	U.S.S. <i>Fischlar</i>	Shanks-class
	U.S.S. <i>Accipiter</i>	Kestrel-class
NCC-1430	U.S.S. <i>Torness</i>	Shanks-class
	U.S.S. <i>Pterodactyl</i>	Kestrel-class
NCC-1431	U.S.S. <i>Verdun</i>	Shanks-class
	U.S.S. <i>Rhamphorynchus</i>	Kestrel-class
NCC-1432	U.S.S. <i>Opelika</i>	Shanks-class
	U.S.S. <i>Mononykus</i>	Kestrel-class
NCC-1433	U.S.S. <i>Walmeir</i>	Shanks-class
	U.S.S. <i>Kremlin</i>	Kremlin-class
	Starship, the first of her class, a survey vessel. The ship was launched in 2226, and had a crew of 86. The ship was 161m long, 99m wide with a height of 26m.	
NCC-1434	U.S.S. <i>Sanchez</i>	Shanks-class
	U.S.S. <i>Shrike</i>	Kestrel-class
	Starship that was placed on display at the Starfleet Museum.	
NCC-1435	U.S.S. <i>Xia</i>	Shanks-class
	U.S.S. <i>Owl</i>	Kestrel-class
NCC-1436	U.S.S. <i>Peleon</i>	Shanks-class
	U.S.S. <i>Peregrine</i>	Kestrel-class
NCC-1437	U.S.S. <i>Yeargone</i>	Shanks-class
	U.S.S. <i>Topaz</i>	Kremlin-class
NCC-1438	U.S.S. <i>Decatur</i>	Shanks-class
	U.S.S. <i>Courageous</i>	Kremlin-class
NCC-1439	U.S.S. <i>Carper</i>	Shanks-class
	U.S.S. <i>Merlin</i>	Kestrel-class
NCC-1440	U.S.S. <i>Tallgo</i>	Shanks-class
	U.S.S. <i>Romeo</i>	Mercury-class
NCC-1441	U.S.S. <i>Oakus</i>	Shanks-class
	U.S.S. <i>Juliet</i>	Mercury-class
NCC-1442	U.S.S. <i>Velociraptor</i>	Kestrel-class
	U.S.S. <i>Greer</i>	
	U.S.S. <i>Nebulary</i>	Constellation-class
NCC-1443	U.S.S. <i>Skua</i>	Kestrel-class
NCC-1444	U.S.S. <i>Hobby</i>	Kestrel-class
NCC-1445	U.S.S. <i>Sparrowhawk</i>	Kestrel-class
NCC-1446	U.S.S. <i>Arybhata</i>	Aryabhata-Class
	First vessel of her class, an explorer. Launched in Marxh of 2222, the ship was 129.3m long, 116m wide and 23.1m high, with a crew compliment of 194 and a mass of 75,111 tones..	
NCC-1447	U.S.S. <i>Prince Henry</i>	Aryabhata-Class
	Starship that became a display piece at the Starfleet Museum.	
NCC-1448	U.S.S. <i>John Burke</i>	Aryabhata-Class
NCC-1449	U.S.S. <i>Van Allen</i>	Aryabhata-Class

NCC-1450

U.S.S. *Hopi*

Hopi-class

Survey vessel, the first of her class. Modular in design, the *Hopi* had four large sensor arrays. Weighing 151,800 metric tones, the ship was 203m long, with a beam of 138.3m and a draft of 92.1m. Crewed by 325 persons, the ship was armed with two dual phaser banks.

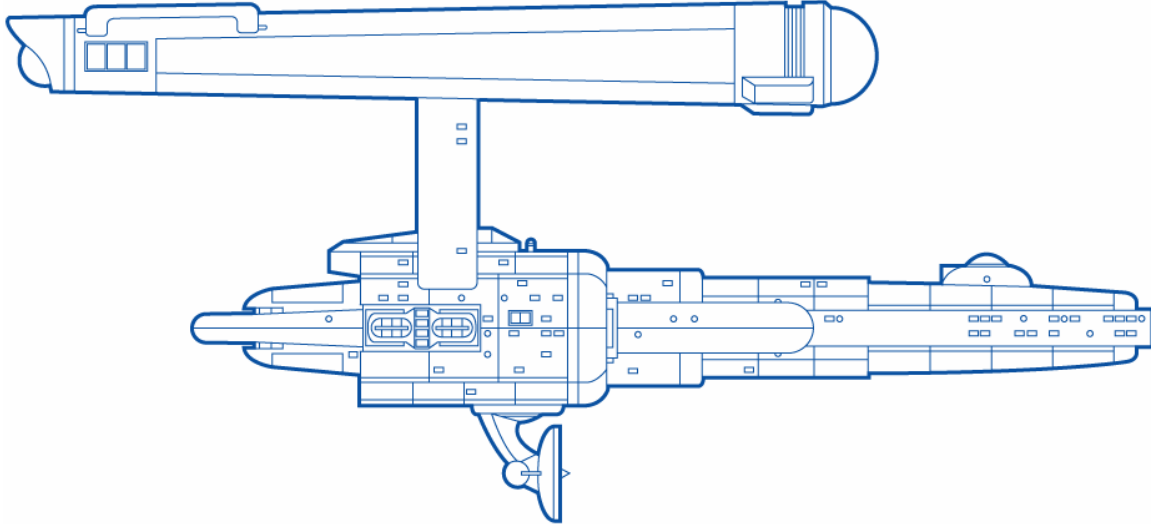

NCC-1451

U.S.S. *Herschell*

Aryabhata-Class

NCC-1452

U.S.S. *Huygens*

Aryabhata-Class

NCC-1453

U.S.S. *Kepler*

Aryabhata-Class

NCC-1454

U.S.S. *Lagrange*

Aryabhata-Class

NCC-1454

U.S.S. *Lowell*

Aryabhata-Class

NCC-1455

U.S.S. *Maury*

Aryabhata-Class

NCC-1456

U.S.S. *Omar Khayyam*

Aryabhata-Class

NCC-1457

U.S.S. *Zheng He*

Aryabhata-Class

NCC-1458

U.S.S. *Aliquippa*

Hopi-class

U.S.S. *Lewis and Clark*

Aryabhata-Class

NCC-1459

U.S.S. *Amundsen*

Aryabhata-Class

NCC-1460

U.S.S. *Aristarchus*

Aryabhata-Class

NCC-1463

U.S.S. *Valley Forge*

Valley Forge-class

Pathfinder vessel of her class, the ship was 245.13m long. With a crew compliment of 325, broken down into 53 officers and 272 crew, the ship was armed with 12 phaser banks and two photon torpedo tubes.

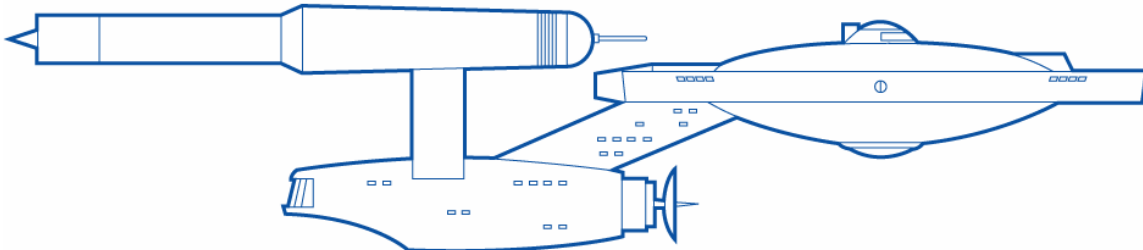

NCC-1464

U.S.S. *Aldrin*

Valley Forge-class

NCC-1465

U.S.S. *Tigress*

Valley Forge-class

NCC-1466

U.S.S. *California*

Valley Forge-class

NCC-1467

U.S.S. *Petrograd*

Valley Forge-class

NCC-1468

U.S.S. *Cougar*

Valley Forge-class

NCC-1469	U.S.S. <i>Independence</i>	Valley Forge-class
NCC-1470	U.S.S. <i>Diana</i>	Valley Forge-class
NCC-1471	U.S.S. <i>Arizona</i>	Valley Forge-class
NCC-1472	U.S.S. <i>O'Bannon</i>	Valley Forge-class
NCC-1473	U.S.S. <i>Tokyo</i>	Valley Forge-class
NCC-1474	U.S.S. <i>Bonderenko</i>	Valley Forge-class
	U.S.S. <i>Juno</i>	Polaris-class
	A destroyer.	
NCC-1475	U.S.S. <i>Europa</i>	Valley Forge-class
NCC-1476	U.S.S. <i>Normandy</i>	Valley Forge-class
NCC-1477	U.S.S. <i>Clarke</i>	Valley Forge-class
NCC-1478	U.S.S. <i>Proteus</i>	Valley Forge-class
NCC-1479	U.S.S. <i>Los Angeles</i>	Valley Forge-class
	U.S.S. <i>Montana</i>	
NCC-1480	U.S.S. <i>Aelita</i>	Valley Forge-class
	U.S.S. <i>Rio Grande</i>	
NCC-1481	U.S.S. <i>Elygren</i>	Valley Forge-class
NCC-1482	U.S.S. <i>Hong Kong</i>	Valley Forge-class
	U.S.S. <i>Pegasus</i>	
NCC-1483	U.S.S. <i>Ishtar</i>	Valley Forge-class
NCC-1484	U.S.S. <i>LaFayette</i>	Valley Forge-class
NCC-1485	U.S.S. <i>Yamato</i>	Valley Forge-class
NCC-1486	U.S.S. <i>Vesta</i>	Valley Forge-class
NCC-1487	U.S.S. <i>Koop</i>	Koop-class
	First vessel of her class, a medical vessel. Dr. Leonard McCoy served on this vessel at one time.	
	U.S.S. <i>Masaryk</i>	Valley Forge-class
NCC-1488	U.S.S. <i>Chernkov</i>	Valley Forge-class
NCC-1489	U.S.S. <i>Oriskany</i>	Valley Forge-class
NCC-1490	U.S.S. <i>Clavius</i>	Valley Forge-class
NCC-1491	U.S.S. <i>Sheridan</i>	Valley Forge-class
NCC-1492	U.S.S. <i>Toklas</i>	Valley Forge-class
NCC-1493	U.S.S. <i>Rattlesnake</i>	Valley Forge-class
	Starship that was a key participant in the battle of Donatu V. The ship was retired and made an exhibit of the Starfleet Museum.	
NCC-1494	U.S.S. <i>Asaph Hall</i>	Valley Forge-class
NCC-1495	U.S.S. <i>Ripley</i>	Valley Forge-class
NCC-1496	U.S.S. <i>Dallas</i>	Valley Forge-class
NCC-1497	U.S.S. <i>Imanot</i>	Barazi-class
	U.S.S. <i>Canberra</i>	Valley Forge-class
NCC-1498	U.S.S. <i>Kora</i>	Polaris-class
	U.S.S. <i>Boxer</i>	Valley Forge-class
NCC-1499	U.S.S. <i>Cheetah</i>	Valley Forge-class

NCC-1500

U.S.S. *Kearsarge*

Kearsarge-class

First vessel of her class, a light cruiser. Its crew compliment was 361.

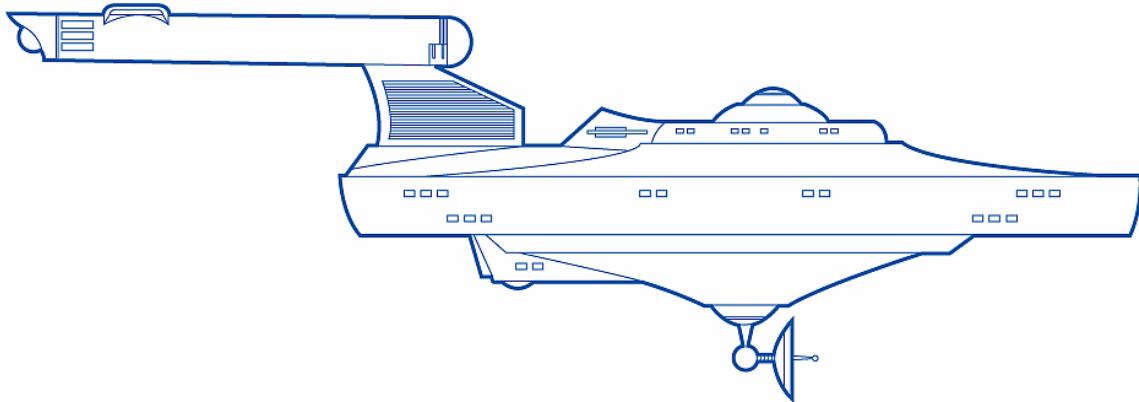

NCC-1501

U.S.S. *Artemis*

Valley Forge-class

U.S.S. *Reliant*

Kearsarge-class

U.S.S. *Scorpion*

Valley Forge-class

NCC-1502

U.S.S. *Alabama*

Kearsarge-class

U.S.S. *Narcissus*

Valley Forge-class

NCC-1503

U.S.S. *Repulse*

Kearsarge-class

U.S.S. *Ganesa*

Valley Forge-class

NCC-1504

U.S.S. *Renown*

Kearsarge-class

U.S.S. *Dolphin*

Valley Forge-class

NCC-1505

U.S.S. *Prince of Wales*

Kearsarge-class

U.S.S. *Vargas*

Valley Forge-class

U.S.S. *Bordeaux*

NCC-1506

U.S.S. *Mutso*

Kearsarge-class

U.S.S. *Anaconda*

Valley Forge-class

NCC-1507

U.S.S. *Jonathan Levy*

Oberth-class

Decorated science vessel under the command of Captain Lightfoot in 2290.

U.S.S. *Nagato*

Kearsarge-class

NCC-1508

U.S.S. *Kaga*

NCC-1509

U.S.S. *Gneisenau*

Kearsarge-class

NCC-1510

U.S.S. *Scharnhorst*

Kearsarge-class

U.S.S. *Montana*

Kremlin-class

NCC-1511

U.S.S. *Prince Eugen*

Kearsarge-class

U.S.S. *Rio Grande*

Kremlin-class

NCC-1512

U.S.S. *Vittorio Vento*

Kearsarge-class

U.S.S. *Bordeaux*

Kremlin-class

NCC-1513

U.S.S. *Littorio*

Kearsarge-class

U.S.S. *Wolf*

Kremlin-class

NCC-1514

U.S.S. *Caio Duilio*

Kearsarge-class

NCC-1515

U.S.S. *Azoz*

Drone cruiser with a crew of 361.

NCC-1516

U.S.S. *Groznyy*

Drone cruiser with a crew of 361.

NCC-1517	U.S.S. <i>Gromykii</i> Drone cruiser with a crew of 361.	
NCC-1518	U.S.S. <i>Dunkerque</i>	Kearsarge-class
NCC-1519	U.S.S. <i>Richelieu</i>	Kearsarge-class
NCC-1520	U.S.S. <i>Strasbourg</i>	Kearsarge-class
	U.S.S. <i>Al-Burak</i>	Al-Burak-class
	Starship, the first vessel of her class. Classified as a carrier, the ship was 245m long, 114.3m wide, and 42.9m high and had a displacement of 156,000 tones. The ship had a crew compliment of 300, and carried 12 Puffin-class fighters.	

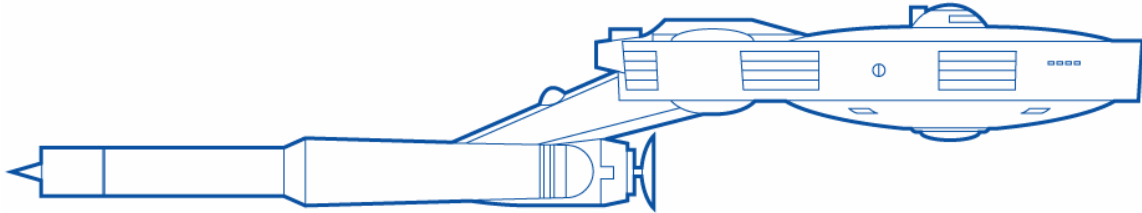

NCC-1521	U.S.S. <i>Rivadavia</i>	Kearsarge-class
	U.S.S. <i>Cardinal</i>	Polaris-class
	U.S.S. <i>Qu-Lin</i>	Al-Burak-class
NCC-1522	U.S.S. <i>Moreno</i>	Kearsarge-class
	U.S.S. <i>Tiamat</i>	Al-Burak-class
NCC-1523	U.S.S. <i>Minas Gerais</i>	Kearsarge-class
	U.S.S. <i>Cyclops</i>	Al-Burak-class
NCC-1524	U.S.S. <i>New Mexico</i>	Kearsarge-class
	U.S.S. <i>Garuda</i>	Al-Burak-class
NCC-1525	U.S.S. <i>Iowa</i>	Kearsarge-class
	U.S.S. <i>Griffon</i>	Al-Burak-class
NCC-1526	U.S.S. <i>Missouri</i>	Kearsarge-class
	U.S.S. <i>Manticore</i>	Al-Burak-class
NCC-1527	U.S.S. <i>Kortenauer</i>	Kearsarge-class
	U.S.S. <i>Chimera</i>	Al-Burak-class
NCC-1528	U.S.S. <i>De Ruyter</i>	Kearsarge-class
	U.S.S. <i>Sok Cho</i>	Polaris-class
	U.S.S. <i>Gorgon</i>	Al-Burak-class
NCC-1529	U.S.S. <i>Naken</i>	Kearsarge-class
	U.S.S. <i>Basilisk</i>	Al-Burak-class
NCC-1530	U.S.S. <i>Glorie</i>	Kearsarge-class
	U.S.S. <i>Thunderbird</i>	Al-Burak-class
NCC-1531	U.S.S. <i>Magellan</i>	Magellan-class
	Pathfinder vessel of her class, it was classified as a galactic survey cruiser.	
	U.S.S. <i>Vindicator</i>	Miranda-class
	U.S.S. <i>Defence</i>	Kearsarge-class
	U.S.S. <i>Pegasus</i>	Al-Burak-class
NCC-1532	U.S.S. <i>Pervenetz</i>	Kearsarge-class
	U.S.S. <i>Virgil</i>	Miranda-class
	U.S.S. <i>Pegasus</i>	Mercury-class
	U.S.S. <i>Centaur</i>	Al-Burak-class

NCC-1533	U.S.S. <i>Meko</i> U.S.S. <i>Ford</i> U.S.S. <i>Babylon</i> U.S.S. <i>Hydra</i>	Kearsarge-class Miranda-class Mercury-class Al-Burak-class
NCC-1534	U.S.S. <i>Vosper</i> U.S.S. <i>Andromeda</i> U.S.S. <i>Dragon</i>	Kearsarge-class Mercury-class Al-Burak-class
NCC-1535	U.S.S. <i>Groton</i> U.S.S. <i>Atlantis</i> U.S.S. <i>Lamia</i>	Kearsarge-class Mercury-class Al-Burak-class
NCC-1536	U.S.S. <i>Ramadan</i> U.S.S. <i>Vanguard</i> U.S.S. <i>Sphinx</i>	Kearsarge-class Miranda-class Al-Burak-class
NCC-1537	U.S.S. <i>Aliyah</i> U.S.S. <i>Venture</i> U.S.S. <i>Naga</i>	Kearsarge-class Miranda-class Al-Burak-class
NCC-1538	Vessel that was put on display at the Starfleet Museum. U.S.S. <i>Assawari</i> U.S.S. <i>Bismarck</i> U.S.S. <i>Satyr</i>	Kearsarge-class Fargo-class Al-Burak-class
NCC-1539	U.S.S. <i>Michigan</i> U.S.S. <i>Kappa</i>	Kearsarge-class Al-Burak-class
NCC-1540	U.S.S. <i>North Carolina</i> U.S.S. <i>Kraken</i>	Kearsarge-class Al-Burak-class
NCC-1541	U.S.S. <i>Sverdlov</i> Drone cruiser with a crew compliment of 361. U.S.S. <i>Nemesis</i>	
NCC-1542	U.S.S. <i>Varyag</i>	Miranda-class
NCC-1543	U.S.S. <i>Mikasa</i> U.S.S. <i>Nemesis</i>	Kearsarge-class Kremlin-class
NCC-1544	U.S.S. <i>Laffey</i> An escort cruiser with a crew of 361. U.S.S. <i>Kronstadt</i>	Kremlin-class
NCC-1545	U.S.S. <i>Wainwright</i> Escort cruiser with a crew of 361. Along with the U.S.S. <i>Patton</i> (NCC-965), it was an escort assigned to the U.S.S. <i>MacArthur</i> , NCC-2201. U.S.S. <i>Dauphin</i>	Kremlin-class

NCC-1547

U.S.S. *Piorun*

Kearsarge-class

U.S.S. *Belleau Wood*

Belleau Wood-class

First starship of her class, classified as an assault transport. Derived in design from the Valley Forge-class, the ship was launched in April of 2230. Designed to carry either 500 or 1000 troops, depending on their roles, the ship was 245.1m long, 114.3m wide and 56.6m high, and had a regular crew compliment of 305. The ship's mass was 209,098 tones.

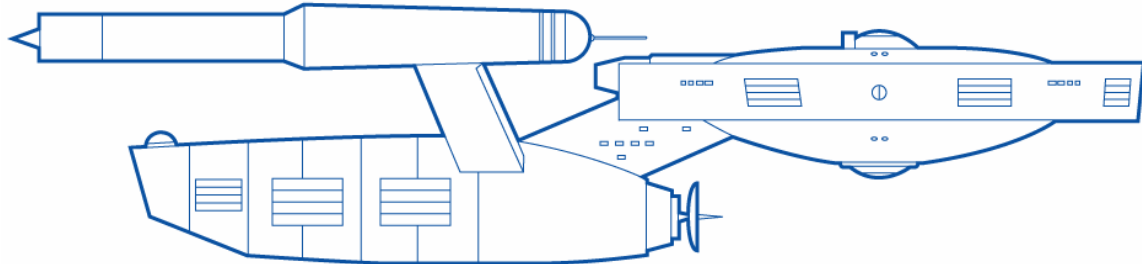

NCC-1548

U.S.S. *Warspite*

Kearsarge-class

U.S.S. *Veracruz*

Belleau Wood-class

NCC-1549

U.S.S. *Hellas Planitia*

Belleau Wood-class

NCC-1550

U.S.S. *Iwo Jima*

Belleau Wood-class

NCC-1551

U.S.S. *Bougainville*

Belleau Wood-class

NCC-1552

U.S.S. *Kitty Hawk*

Kitty Hawk-class

Cruiser, the first of her class. Commissioned in 2231, the ship was 178.5m long, 81.3m wide and 41.3m and weighed 357,650 metric tones. The crew compliment was 159 persons.

U.S.S. *Okinawa*

Belleau Wood-class

The last vessel of her class to be retired, in 2276.

NCC-1553

U.S.S. *Quebec*

Belleau Wood-class

NCC-1554

U.S.S. *Bataan*

Belleau Wood-class

NCC-1555

U.S.S. *Dieppe*

Belleau Wood-class

NCC-1556

U.S.S. *Pennsylvania*

Starship, a light cruiser.

U.S.S. *Saipan*

Belleau Wood-class

NCC-1557

U.S.S. *Argonne*

Belleau Wood-class

NCC-1558

U.S.S. *Taurus*

Taurus-class

Heavy cruiser, the first ship of her class, launched in 2236. 167.9m long, 83.3m wide and 33.8m high, the ship had a crew of 167 and had a weight of 312,500 metric tones. From 2236 to 2241, it was assigned to patrol duties of the Vulcanis system and surrounding space.

U.S.S. *Tripoli*

Belleau Wood-class

NCC-1559

U.S.S. *Brandywine*

Belleau Wood-class

NCC-1560

U.S.S. *Luzon*

Belleau Wood-class

NCC-1561

U.S.S. *Rodger Young*

Belleau Wood-class

NCC-1562

U.S.S. *William Mandella*

Belleau Wood-class

Starship that was a participant in landings at Lisyk VIII, Thaae, and Corf I was put on permanent display at the Starfleet Museum.

NCC-1563

U.S.S. *Marygay Potter*

Belleau Wood-class

NCC-1564

U.S.S. *Hoerner*

Aegis cruiser with a standard crew of 361.

U.S.S. *Sevastapol*

Belleau Wood-class

NCC-1565 U.S.S. *Chernavin*
Aegis cruiser with a standard crew of 361.

NCC-1566 U.S.S. *Malta* Belleau Wood-class
U.S.S. *Soult*
Aegis cruiser with a standard crew of 361.

NCC-1567 U.S.S. *Yadalla* Belleau Wood-class
NCC-1571 U.S.S. *Pandora* Polaris-class
U.S.S. *Cautious*
Minesweeper with a crew of 361.

NCC-1572 U.S.S. *Meticulous*
Minesweeper with a crew compliment of 361.

NCC-1573 U.S.S. *Cordelia* Miranda-class
NCC-1576 U.S.S. *Washington* Mercury-class
NCC-1577 U.S.S. *Pluto* Mercury-class
NCC-1578 U.S.S. *Attica* Mercury-class
NCC-1580 U.S.S. *Clausewitz*
Command cruiser with a crew compliment of 361.

NCC-1581 U.S.S. *Sun Tzu*
Command cruiser with a crew compliment of 361.
U.S.S. *Lindbergh* Kitty Hawk-class
Vessel destroyed in the Zeta Perseid system in 2239.

NCC-1582 U.S.S. *Jomini*
Command cruiser with a crew compliment of 361.
U.S.S. *Dauphin*

NCC-1583 U.S.S. *Tacitus*
Command cruiser with a crew compliment of 361.
U.S.S. *Earhart* Kitty Hawk-class
Crippled by Klingon raiders in 2242, it was rebuilt as an Academy training vessel in 2247.

NCC-1584 U.S.S. *Mahan*
Command cruiser with a crew compliment of 361.

NCC-1585 U.S.S. *Clancy*
Command cruiser with a crew compliment of 361.

NCC-1586 U.S.S. *Coyle*
Command cruiser with a crew compliment of 361.
U.S.S. *Aries* Taurus-class
Participated in the 2242 Battle of Donatu V, destroyed later that same year.

NCC-1587 U.S.S. *Webber*
Command cruiser with a crew compliment of 361.

NCC-1588 U.S.S. *Boeing* Kitty Hawk-class
NCC-1589 U.S.S. *Siegfried* Siegfried-class
First vessel of her class, a dreadnought. Displacing 199,320 tones, the ship was 252.5m long, 114.3m wide and 63.6m long, and had a crew compliment of 419.

U.S.S. *Ise*
Heavy fighter-carrier with a standard crew of 361.
U.S.S. *Pluto*

NCC-1590	U.S.S. <i>Sampson</i>	Siegfried-class
	U.S.S. <i>Scorpio</i>	Taurus-class
	Vessel whose entire crew vanished, leaving the vessel unharmed under mysterious circumstances in 2253, later believed to have been an Excalbian experiment. It was recreated and continued on to have two 5 year missions under Captain Thomas Dunbar and was decommissioned in 2264.	
	U.S.S. <i>Thunderbolt</i>	Thunderbolt-class
	A fast destroyer, the prototype vessel of her class. Sometimes known as the "Quick-Response Destroyer" because of it's ability to race to any trouble scene, the ship was crewed by 305 people. The ship was armed with six dual phaser banks and two torpedo tubes, and the ship weighed 125,000 metric tones. It was 200m long, 141.7m wide and 70m high.	
	U.S.S. <i>Hyuga</i>	
	Heavy fighter-carrier with a crew of 361.	
NCC-1591	U.S.S. <i>Beowulf</i>	Siegfried-class
	U.S.S. <i>Kiev</i>	
	Light carrier with a crew of 361.	
NCC-1592	U.S.S. <i>Perseus</i>	Siegfried-class
	U.S.S. <i>Mali</i>	Miranda-class
	U.S.S. <i>Hosho</i>	
	Light carrier with a crew of 361.	
	U.S.S. <i>Mesopotamia</i>	
NCC-1593	U.S.S. <i>Lysander</i>	Siegfried-class
	U.S.S. <i>Udzha</i>	Miranda-class
	U.S.S. <i>Princeton</i>	
	Light carrier with a crew of 361.	
NCC-1594	U.S.S. <i>Horatio</i>	Siegfried-class
	U.S.S. <i>Veinticinco De Mayo</i>	
	Light carrier with a crew of 361.	
NCC-1595	U.S.S. <i>Hercules</i>	Siegfried-class
	U.S.S. <i>Hermes</i>	
	Strike carrier with a crew of 361.	
NCC-1596	U.S.S. <i>Alexander</i>	Siegfried-class
	Vessel that was put on display at the Starfleet Museum.	
	U.S.S. <i>Vikrant</i>	
	Strike carrier with a crew of 361	
NCC-1597	U.S.S. <i>Vercingetorix</i>	Siegfried-class
	U.S.S. <i>Clemenceu</i>	
	Strike carrier with a crew of 361	
NCC-1598	U.S.S. <i>Scovil</i>	
	Vessel that was assigned to astronomical research on stardate 9521.	
	U.S.S. <i>Gilgamesh</i>	Siegfried-class
	U.S.S. <i>Garibaldi</i>	
	Strike carrier with a crew of 361	
NCC-1599	U.S.S. <i>Hector</i>	Siegfried-class

NCC-1600

U.S.S. *Baton Rogue*

Baton Rogue-class

Command cruiser, the first vessel of her class.

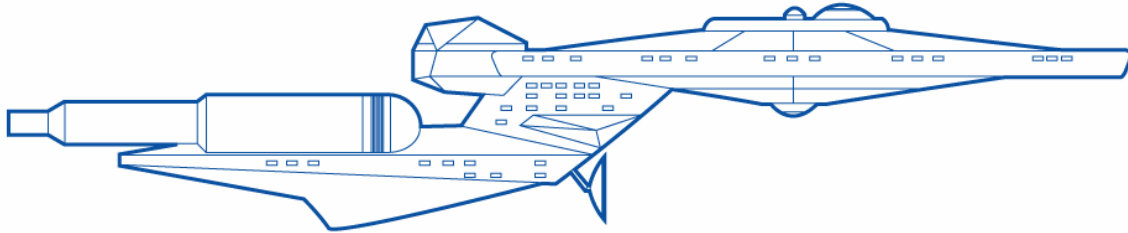

NCC-1601

U.S.S. *Musashi*

Siegfried-class

U.S.S. *Agincourt*

Constitution-class

Starship with a very multi-racial crew. Commanded by Captain N'hran Th'ersa.

U.S.S. *Charlemagne*

Siegfried-class

NCC-1602

U.S.S. *Siva*

Siegfried-class

U.S.S. *Vulture*

Constitution-class

NCC-1603

U.S.S. *Ballista*

Constitution-class

NCC-1604

U.S.S. *Barr*

Constitution-class

NCC-1605

U.S.S. *Reprisal*

Constitution-class

NCC-1606

U.S.S. *Cerebus*

Cerebus-class

First vessel of her class, designated a frigate by Starfleet.

NCC-1607

U.S.S. *Kobayashi Maru*

NCC-1619

U.S.S. *Potomac*

NCC-1622

U.S.S. *Savannah*

Savannah-class

Prototype of her class, it's shuttlecraft #1 was named *Balboa*.

U.S.S. *Virgo*

Taurus-class

Starship destroyed by a warp core overload in 2261.

NCC-1623

U.S.S. *Valiant*

Constitution-class

NCC-1627

U.S.S. *Wayfarer*

Wayfarer-class

First starship of her class.

NCC-1630

U.S.S. *Hunt*

Hunt-class

Prototype of her class, a light cruiser.

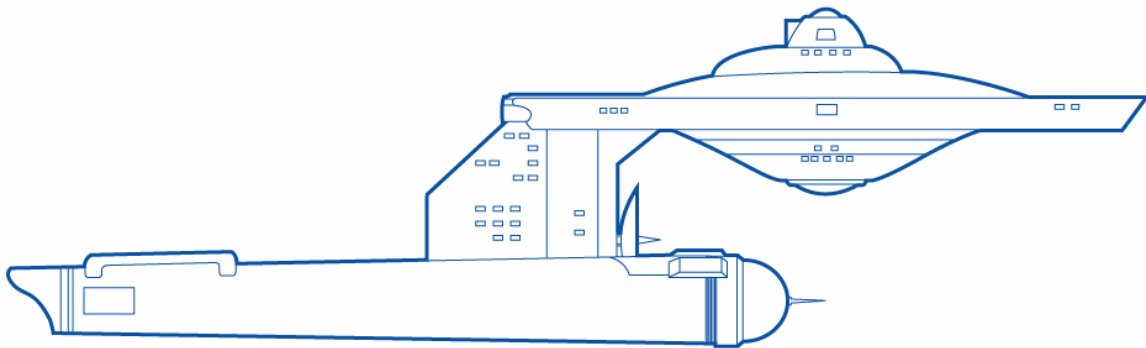

NCC-1638

U.S.S. *Sagittarius*

Taurus-class

NCC-1639

U.S.S. *Mesopotamia*

Kremlin-class

NCC-1640

U.S.S. *Potomac*

Kremlin-class

NCC-1641

U.S.S. *New Berlin*

Kremlin-class

U.S.S. *Archanis*

Kremlin-class

NCC-1647	U.S.S. <i>Farragut</i>	Constitution-class
	One of the original twelve Constitution-class vessels. Former postings of James T. Kirk and Andovar Drake. In 2257, while under the command of Captain Charles Garrovick, two hundred of her crew were killed by a vampiric cloud creature.	
NCC-1651	U.S.S. <i>Chicago</i>	
	Heavy cruiser with a crew of 404.	
NCC-1652	U.S.S. <i>New York</i>	
	Heavy cruiser with a crew of 404.	
	U.S.S. <i>Aarchanis</i>	
NCC-1653	U.S.S. <i>Dayton</i>	
	Heavy cruiser with a crew of 404.	
NCC-1654	U.S.S. <i>Los Angeles</i>	
	Heavy cruiser with a crew of 404.	
NCC-1655.	U.S.S. <i>Electra</i>	Polaris-class
	U.S.S. <i>London</i>	
	Heavy cruiser with a crew of 404.	
	U.S.S. <i>Attica</i>	
NCC-1656	U.S.S. <i>Nemesis</i>	Neihardt-class
	A heavy cruiser.	
	U.S.S. <i>Tokyo</i>	
	Heavy cruiser with a crew of 404.	
NCC-1657	U.S.S. <i>Potemkin</i>	Constitution-class
	One of the original 12 Constitution-class starships, notable as being one of the vessels to participate in the disastrous M-5 tests of 2268.	
	U.S.S. <i>Beijing</i>	
	Heavy cruiser with a crew of 404.	
NCC-1658	U.S.S. <i>Berlin</i>	
	Heavy cruiser with a crew of 404.	
NCC-1659	U.S.S. <i>Mecca</i>	
	Heavy cruiser with a crew of 404.	
NCC-1660	U.S.S. <i>Buenos Aires</i>	
	Heavy cruiser with a crew of 404.	
NCC-1661	U.S.S. <i>Kinshasa</i>	
	Heavy cruiser with a crew of 404.	
NCC-1664	U.S.S. <i>Excalibur</i>	Constitution-class
	One of the original twelve Constitution-class starships, it was commanded by Captain Rollin Bannok at the Battle of Donatu V. Later, the vessel was commanded by Captain Harris, He and the entire ship's crew were killed by the disastrous M-5 tests of 2268. The ship survived, was refurbished, and later commanded by Captain DeCampo.	
NCC-1666	U.S.S. <i>Dragonfire</i>	
NCC-1670	U.S.S. <i>Pyotr Velikiy</i>	Pyotr Velikiy-class
	First vessel of her class. Developed in conjunction with the Constitution-class, the ship 250.3m long, 169.1m wide and 36.5m high, displaced 280,000 metric tones and had a crew of 500.	
NCC-1671	U.S.S. <i>Shrelev</i>	Pyotr Velikiy-class
NCC-1672	U.S.S. <i>Exeter</i>	Constitution-class
	One of the original twelve Constitution-class starships. The entire crew, while under the command of Captain Ronald Tracey, was killed by an ancient	

biological weapon. The ship itself remained on active duty and was later commanded by both Captain John Quincy Garrovick, and Captain Styles.

	U.S.S. <i>Yi Sun-Shin</i>	Pyotr Velikiy-class
NCC-1673	U.S.S. <i>John Paul Jones</i>	Pyotr Velikiy-class
NCC-1674	U.S.S. <i>Tav</i>	Pyotr Velikiy-class
NCC-1675	U.S.S. <i>Elizibeth I</i>	Pyotr Velikiy-class
NCC-1676	U.S.S. <i>Etrox</i>	Pyotr Velikiy-class
NCC-1677	U.S.S. <i>Togo</i>	Pyotr Velikiy-class
NCC-1678	U.S.S. <i>Rommel</i>	Pyotr Velikiy-class
NCC-1679	U.S.S. <i>Friedrich Barbarosa</i>	Pyotr Velikiy-class
NCC-1680	U.S.S. <i>Goyathlay</i>	Pyotr Velikiy-class
NCC-1681	U.S.S. <i>Washington</i>	Pyotr Velikiy-class
NCC-1682	U.S.S. <i>Niakenchiis</i>	Pyotr Velikiy-class
NCC-1683	U.S.S. <i>Salah Ad-Din</i>	Pyotr Velikiy-class
	The last vessel of her class to be retired, this vessel was placed in the Starfleet Museum.	
NCC-1684	U.S.S. <i>Giap</i>	Pyotr Velikiy-class
NCC-1685	U.S.S. <i>Hannibal</i>	Pyotr Velikiy-class
	U.S.S. <i>Heston</i>	Heston-class
	Prototype of the Heston class, a heavy cruiser.	
NCC-1686	U.S.S. <i>Zulu</i>	Kremlin-class
	U.S.S. <i>Zerisshebi</i>	Pyotr Velikiy-class
NCC-1687	U.S.S. <i>Dragon</i>	Kremlin-class
	U.S.S. <i>De Grasse</i>	Pyotr Velikiy-class
NCC-1688	U.S.S. <i>Rexx</i>	Pyotr Velikiy-class
NCC-1689	U.S.S. <i>Gantu</i>	Pyotr Velikiy-class
NCC-1691	U.S.S. <i>Asimov</i>	Constitution-class
NX-1692	U.S.S. <i>Glen Coe</i>	Glen Coe-class
	First vessel of her class, a perimeter action vessel.	
NCC-1692	U.S.S. <i>Helin</i>	
	The <i>Helin</i> was a scientific survey ship on Neutral Zone patrol in Sector 21290 in 2293, stardate 9521.	
NCC-1697	U.S.S. <i>Essex</i>	Constitution-class
NCC-1699	U.S.S. <i>Richtofen</i>	Larson-class
NCC-1700	U.S.S. <i>Constitution</i>	Constitution-class
	Pathfinder vessel of the famous Constitution-class. The ship weighed 190,000 and was 288.646m long, 127.102m wide, and 72.6m high. It originally had a crew of 203, this was later boosted to 430 though a refit program. Montgomery Scott once served aboard the <i>Constitution</i> . During the ship's initial testing phase, the ship may have bore the registry number NX-1700. It was destroyed in 2268 by an encounter with a subspace rift.	

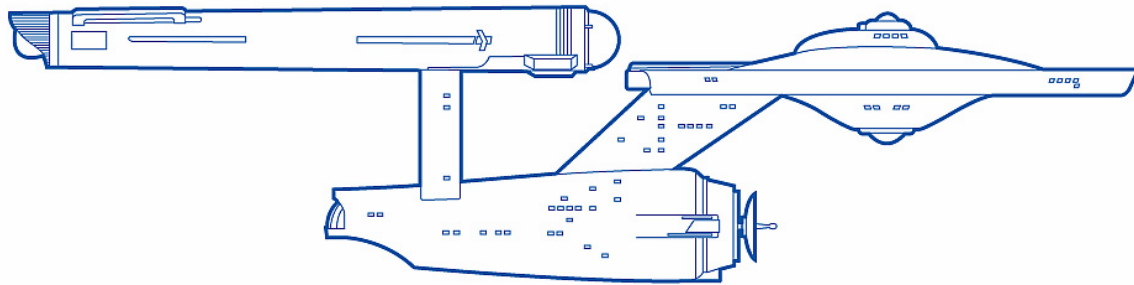

- NCC-1701 U.S.S. *Enterprise* Constitution-class
 Launched in 2245, the *Enterprise* had five commanders during her forty years of service; Captain Robert April, Captain Christopher Pike, Captain James T. Kirk, Captain Willard Decker and Captain Spock of Vulcan. The ship went through two major refits, one in 2261 and an intensive overhaul/redesign in 2269-71. The ship's motto was "...to boldly go where no man has gone before.". The ship was self-destructed at the Genesis planet by Admiral Kirk to prevent it from falling into Klingon hands. It was the first Federation starship to bear the name.
- NCC-1701-A U.S.S. *Enterprise* Constitution-class
 Second starship to bear the name. It was commissioned on Stardate 8442.5 from the San Francisco Fleet Yards. It remained under the command of James T. Kirk until its destruction at planet Chal in 2293.
- NCC-1701-B U.S.S. *Enterprise* Excelsior-class
 Third starship to bear the name, the *Enterprise-B* was commissioned on stardate 9715.5 under the command of Captain John Harriman.
- NCC-1701-C U.S.S. *Enterprise* Ambassador-class
 Fourth vessel to bear the name. Built at Earth Station McKinnley, the ship was lost in 2344 defending the Klingon outpost of Narendra III while under the command of Captain Rachel Garrett.
- NCC-1701-D U.S.S. *Enterprise* Galaxy-class
 Fifth vessel to bear the name, the third Galaxy-class vessel to be launched. The ship was commissioned on stardate 40759.9 from the Utopia Planitia Fleet Yards, Mars, under the command of Jean-Luc Picard. During its illustrious career, it was also commanded by Captain William T. Riker and Captain Edward Jellico. The ship crash-landed and was destroyed in the Veridian system in 2371.
- NCC-1701-E U.S.S. *Enterprise* Sovereign-class
 Sixth Federation starship to bear the name, this, the second vessel of the Sovereign-class, was launched from the San Francisco Fleet Yards on stardate 49027.5 under the command of Jean-Luc Picard.
- NCC-1701-F U.S.S. *Enterprise*
 Seventh Federation starship to bear the name.
- NCC-1701-G U.S.S. *Enterprise*
 Eighth Federation starship to bear the name.
- NCC-1701-H U.S.S. *Enterprise*
 Ninth Federation starship to bear the name.
- NCC-1701-I U.S.S. *Enterprise*
 Tenth Federation starship to bear the name.
- NCC-1701-J U.S.S. *Enterprise*
 Eleventh Federation starship to bear the name.
- NCC-1703 U.S.S. *Hood* Constitution-class
 One of the twelve original Constitution-class starships. The ship had at least five different commanding officers during its impressive career: Captain Kenneth

	Dodge, Captain Mark Rousseau, Captain Hojo Yorii, Captain Joaquin Martinez and Captain Lustig. Montgomery Scott once served aboard the <i>Hood</i> . It participated in the 2268 tests of the M-5 computer unit. Later that same year the ship's crew were killed by Romulan forces, though the ship itself was saved.	
NCC-1709	U.S.S. <i>Lexington</i>	Constitution-class
	One of the twelve original Constitution-class starships. The ship participated in the disastrous M-5 tests of 2268 while under the command of Commodore Robert Wesley.	
	U.S.S. <i>Christopher Pike</i>	Constitution-class
NCC-1710	U.S.S. <i>Kongo</i>	Constitution-class
	One of the twelve original Constitution-class starships. At one time commanded by Captain Toroyan, on stardate 9521 it was on Neutral Zone patrol.	
NCC-1712	U.S.S. <i>BonHomme Richard</i>	BonHomme Richard-class
	First vessel of her class, a sub-class of the Constitution-class design. James T. Kirk served aboard this vessel early in his career.	
NX-1713	U.S.S. <i>Confederate</i>	Constitution-class
	Experimental vessel that was used to test the "Warp-Accelerator Drive", a propulsion system based on designs by Virgil Brahms. Intended for near-transwarp speeds, it didn't work successfully. On it's maiden voyage the ship was captured by Romulan force and subsequently transported though time to the year 2371, where it was destroyed.	
NCC-1713	U.S.S. <i>Monitor</i>	BonHomme Richard-class
NCC-1714	U.S.S. <i>Hornet</i>	BonHomme Richard-class
	At one time, the <i>Hornet</i> was commanded by Captain Stephen Leedson.	
NCC-1715	U.S.S. <i>Merrimac</i>	BonHomme Richard-class
NCC-1716	U.S.S. <i>Endeavor</i>	BonHomme Richard-class
NCC-1717	U.S.S. <i>Yorktown</i>	Constitution-class
	Launched in 2247 from the San Fransisco Fleet Yards, it was one of the original twelve Constitution-class starships. In 2286 the <i>Yorktown</i> was commanded by Captain Joel Randolph. Previous commanding officers included Captain Jarobe, Captain Matthew Decker and Captain von Holtzbrinck. The ship was later retired and became a part of the Starfleet Museum at Starbase 178.	
	U.S.S. <i>Defiance</i>	BonHomme Richard-class
NCC-1718	U.S.S. <i>Excelsior</i>	BonHomme Richard-class
NCC-1719	U.S.S. <i>Eagle</i>	BonHomme Richard-class
NCC-1720	U.S.S. <i>Lafayette</i>	BonHomme Richard-class
NCC-1721	U.S.S. <i>Wasp</i>	BonHomme Richard-class
	U.S.S. <i>Seneca</i>	
NCC-1722	U.S.S. <i>El Dorado</i>	BonHomme Richard-class
	Former posting of James T. Kirk, during which time the ship was commanded by Prince Fiawol of Andor.	
NCC-1723	U.S.S. <i>Ari</i>	BonHomme Richard-class
NCC-1724	U.S.S. <i>Saratoga</i>	BonHomme Richard-class
NCC-1725	U.S.S. <i>Tori</i>	BonHomme Richard-class
NCC-1726	U.S.S. <i>Krieger</i>	BonHomme Richard-class
	In 2269, the <i>Krieger</i> found a derelict free-trader infested with Udarian blood-maggots near the Beta Lyrae system.	
NCC-1727	U.S.S. <i>Essex</i>	
	Decommissioned in 2295.	

NCC-1728	U.S.S. <i>Truxton</i> Commissioned in 2275.	Constitution-class
	U.S.S. <i>Constellation</i>	BonHomme Richard-class
	Ship destroyed in 2285 when it encountered a bizarre phenomenon known as the EMP Effect. At the time of it's destruction it had been commanded by Captain Carmen Ikeya, and had previously been commanded by Captain Aya Nakajima.	
	U.S.S. <i>Gettysburg</i>	Gettysburg-class
	Pathfinder vessel of her class, a command cruiser with a crew of 483. It had a 20 percent increase in phaser output power over standard Constitution-class ships, and had a warp-capable saucer hull.	
NCC-1729	U.S.S. <i>Confiance</i>	Constitution-class
	U.S.S. <i>Farragut</i>	BonHomme Richard-class
	U.S.S. <i>Kadesh</i>	Gettysburg-class
NCC-1730	U.S.S. <i>Bunker Hill</i> Commissioned in 2275.	Constitution-class
	U.S.S. <i>Intrepid</i>	BonHomme Richard-class
	Launched in 2269 under the command of Captain Suvuk of Vulcan.	
	U.S.S. <i>Thermopolaë</i>	Gettysburg-class
NCC-1731	U.S.S. <i>La Vengeance</i> Commissioned in 2275.	Constitution-class
	U.S.S. <i>Valiant</i>	BonHomme Richard-class
	U.S.S. <i>Cannae</i>	Gettysburg-class
NCC-1732	U.S.S. <i>John Muir</i> Starship, it was receiving a systems upgrade at Starbase 24 on stardate 9521.	
	U.S.S. <i>Achernar</i>	Achernar-class
	First vessel of her class, a sub-class of the Constitution-class design.	
NCC-1733	U.S.S. <i>Sol</i>	Achernar-class
NCC-1734	U.S.S. <i>Jupiter</i>	Achernar-class
NCC-1735	U.S.S. <i>Rigel Kentaurus</i>	Achernar-class
	U.S.S. <i>Tannenberg</i>	Gettysburg-class
NCC-1736	U.S.S. <i>Quindar</i>	Achernar-class
	U.S.S. <i>Kursk</i>	Constitution-class
NCC-1737	U.S.S. <i>Coral Sea</i>	Gettysburg-class
	U.S.S. <i>Proxima</i>	Achernar-class
NCC-1738	U.S.S. <i>Androclus</i>	Achernar-class
NCC-1739	U.S.S. <i>Astrad</i>	Achernar-class
NCC-1740	U.S.S. <i>Mondoloy</i>	Achernar-class
NCC-1741	U.S.S. <i>Alfr</i>	Achernar-class
NCC-1742	U.S.S. <i>Thelonii</i>	Achernar-class
NCC-1743	U.S.S. <i>Xanthii</i>	Achernar-class
NCC-1744	U.S.S. <i>Sirius</i> Ship that was commanded by Gregory Calkins early in his career.	Achernar-class
NCC-1745	U.S.S. <i>Shahr</i>	Achernar-class
NCC-1746	U.S.S. <i>Pilar</i>	Achernar-class
NCC-1747	U.S.S. <i>Tholus</i>	Achernar-class
NCC-1748	U.S.S. <i>Horok</i>	Achernar-class

NCC-1749	U.S.S. <i>Vincennes</i>	Vincennes-class
	Pathfinder of her class, a more powerful heavy cruiser variant. Eleven of the class were built, each having a crew of 501.	
	U.S.S. <i>Ghondr</i>	Achernar-class
NCC-1750	U.S.S. <i>Pelione</i>	Achernar-class
NCC-1751	U.S.S. <i>Kirov</i>	Kirov-class
	First vessel of her class, a battle cruiser with a crew compliment of 503.	
	U.S.S. <i>Tali</i>	Achernar-class
NCC-1752	U.S.S. <i>Australia</i>	Kirov-class
	U.S.S. <i>Annobon</i>	Achernar-class
NCC-1753	U.S.S. <i>New Zealand</i>	Kirov-class
	U.S.S. <i>Caspan</i>	Achernar-class
NCC-1754	U.S.S. <i>Shangri-La</i>	
	Battle carrier with a crew of 503. The <i>Shangri-La</i> had a distinguished career, becoming known as a 'ghost ship' because of it's sudden appearances in various engagements. The sister ship to the U.S.S. <i>Atlantis</i> NCC-1764.	
	U.S.S. <i>Jassan</i>	Achernar-class
NCC-1755	U.S.S. <i>Paegan</i>	Achernar-class
NCC-1756	U.S.S. <i>Procyon</i>	Achernar-class
NCC-1757	U.S.S. <i>Tubman</i>	
	U.S.S. <i>Phardos</i>	Achernar-class
	Spock once served aboard this ship under the command of Captain Abd-ul Aziz, a very prejudicial officer.	
NCC-1757-A	U.S.S. <i>Tubman</i>	
NCC-1757-B	U.S.S. <i>Tubman</i>	
	The <i>Tubman</i> remained on duty in the late 24 th century as a Starfleet Academy training vessel.	
NCC-1758	U.S.S. <i>Ndele</i>	Achernar-class
NCC-1759	U.S.S. <i>Zindar</i>	Achernar-class
NCC-1760	U.S.S. <i>Za-faran</i>	Achernar-class
NCC-1761	U.S.S. <i>Otto Von Bismarck</i>	Bismarck-class
	Battle cruiser that borrowed technology from the Gorn, with a crew of 503.	
	U.S.S. <i>Oomaru</i>	Achernar-class
NCC-1762	U.S.S. <i>Nathan Bedford Forrest</i>	Bismarck-class
	U.S.S. <i>Yaan</i>	Achernar-class
NCC-1763	U.S.S. <i>Nikolai V Ogarkov</i>	Bismarck-class
	U.S.S. <i>Temir</i>	Achernar-class
NCC-1764	U.S.S. <i>Defiant</i>	Constitution-class
	The <i>Defiant</i> vanished into a spatial-interphase rift near Tholian space in 2268.	
	U.S.S. <i>Atlantis</i>	
	Battle carrier with a crew of 503. It's sister ship was the U.S.S. <i>Shangri-La</i> , NCC-1754.	
	U.S.S. <i>Galina</i>	Achernar-class
NCC-1765	U.S.S. <i>Samaara</i>	Achernar-class
NCC-1766	U.S.S. <i>Kestral</i>	Achernar-class
NCC-1767	U.S.S. <i>Kep Salu</i>	Achernar-class
NCC-1768	U.S.S. <i>Ketoi</i>	Achernar-class
NCC-1769	U.S.S. <i>Kars</i>	Achernar-class
NCC-1770	U.S.S. <i>Sinuiji</i>	Achernar-class

NCC-1771	U.S.S. <i>Revolution</i>	Vincennes-class
	U.S.S. <i>Ekinus</i>	Achernar-class
NCC-1772	U.S.S. <i>Pari Commune</i>	Vincennes-class
	U.S.S. <i>Oblik</i>	Achernar-class
NCC-1773	U.S.S. <i>Ayacucho</i>	Vincennes-class
	U.S.S. <i>Mengen</i>	Achernar-class
NCC-1774	U.S.S. <i>Long March</i>	Vincennes-class
	U.S.S. <i>Salayna</i>	Achernar-class
NCC-1775	U.S.S. <i>Krasny Barikaddy</i>	Vincennes-class
	U.S.S. <i>Qizan</i>	Achernar-class
NCC-1776	U.S.S. <i>Qual'at</i>	Achernar-class
NCC-1777	U.S.S. <i>Tulan</i>	Achernar-class
NCC-1778	U.S.S. <i>Mazda</i>	Achernar-class
NCC-1779	U.S.S. <i>Esabl</i>	Achernar-class
NCC-1780	U.S.S. <i>Zaahm</i>	Achernar-class
NCC-1781	U.S.S. <i>Alferaz</i>	Achernar-class
NCC-1782	U.S.S. <i>Hajj</i>	Achernar-class
NCC-1783	U.S.S. <i>Tajarhi</i>	Achernar-class
NCC-1784	U.S.S. <i>Armstrong</i>	Miranda-class
	U.S.S. <i>Kasimar</i>	Achernar-class
NCC-1785	U.S.S. <i>Mongo</i>	Achernar-class
NCC-1786	U.S.S. <i>Gihar</i>	Achernar-class
NCC-1787	U.S.S. <i>Pari</i>	Achernar-class
NCC-1788	U.S.S. <i>Mirazh</i>	Achernar-class
NCC-1789	U.S.S. <i>Eskiis</i>	Achernar-class
NCC-1790	U.S.S. <i>Ahzdar</i>	Achernar-class
NCC-1791	U.S.S. <i>Jenshahn</i>	Achernar-class
NCC-1792	U.S.S. <i>Elohim</i>	Achernar-class
NCC-1793	U.S.S. <i>Hiemdal</i>	Achernar-class
NCC-1794	U.S.S. <i>Maat</i>	Achernar-class
NCC-1795	U.S.S. <i>Shaandra</i>	Achernar-class
NCC-1796	U.S.S. <i>Alam'ak</i>	Achernar-class
NCC-1797	U.S.S. <i>Behr'ak</i>	Achernar-class
NCC-1798	U.S.S. <i>Ti-Ho</i>	Constitution-class
	Starship that served as a tested for transwarp drive along with the U.S.S. <i>Excelsior</i> NX-2000. It utilized an M-6 Mark II computer system.	
	U.S.S. <i>Czar'ak</i>	Achernar-class
	U.S.S. <i>Discovery</i>	Constitution-class
NCC-1799	U.S.S. <i>Tutakai</i>	Achernar-class
NX-1800	U.S.S. <i>Phoenix</i>	Phoenix-class
	First vessel of her class.	
NCC-1800	U.S.S. <i>Tikopai</i>	Tikopai-class
	First vessel of her class, a sub-class of the Constitution-class design.	
	U.S.S. <i>Benning</i>	Benning-class
	Starship, first of her class, designated a frigate.	
	U.S.S. <i>Byrd</i>	
	Galactic survey cruiser with a crew of 451.	

NCC-1801	U.S.S. <i>Columbus</i> Galactic survey cruiser with a crew of 451.	
	U.S.S. <i>K'ushui</i>	Tikopai-class
NCC-1802	U.S.S. <i>Darwin</i> Galactic survey cruiser with a crew compliment of 451.	
	U.S.S. <i>K'hotan</i>	Tikopai-class
	Known for single-handedly repelling a Romulan advance. Number One served on the <i>K'hotan</i> prior to serving on the U.S.S. <i>Enterprise</i> NCC-1701.	
NCC-1803	U.S.S. <i>Lewis & Clark</i> Galactic survey cruiser with a crew of 451.	
	U.S.S. <i>Altair</i>	Tikopai-class
	Dr. Phillip Boyce once served on this vessel, along with Dr. Stewart Baumgard.	
NCC-1804	U.S.S. <i>Magellan</i> Galactic survey cruiser with a crew of 451.	
	U.S.S. <i>Fomalhaut</i>	Tikopai-class
NCC-1805	U.S.S. <i>Courageous</i>	Miranda-class
	Commanded by Captain March, this vessel was destroyed in 2285.	
	U.S.S. <i>Marco Polo</i> Galactic survey cruiser with a crew compliment of 451.	
	U.S.S. <i>Nakarat</i>	Tikopai-class
NCC-1806	U.S.S. <i>Cousteau</i> Galactic survey cruiser with a crew of 451.	
	U.S.S. <i>Vega</i>	Tikopai-class
NCC-1807	U.S.S. <i>Sagan</i> Galactic survey cruiser with a crew of 451.	
	U.S.S. <i>Arcturus</i>	Tikopai-class
	Former posting of Hikaru Sulu.	
NCC-1808	U.S.S. <i>Armstrong</i> Galactic survey cruiser with a crew of 451.	
	U.S.S. <i>Pollux</i>	Tikopai-class
NCC-1809	U.S.S. <i>Challenger</i> Galactic survey cruiser with a crew of 451.	
	U.S.S. <i>Capella</i>	Tikopai-class
NCC-1810	U.S.S. <i>Darion</i>	Tikopai-class
NCC-1811	U.S.S. <i>Sardar</i>	Tikopai-class
NCC-1812	U.S.S. <i>Aldebaran</i>	Tikopai-class
NCC-1813	U.S.S. <i>Hor</i>	Tikopai-class
NCC-1814	U.S.S. <i>Canopus</i>	Tikopai-class
NCC-1815	U.S.S. <i>Spica</i>	Tikopai-class
NCC-1816	U.S.S. <i>Agena</i>	Tikopai-class
NCC-1817	U.S.S. <i>Vena</i>	Tikopai-class
NCC-1818	U.S.S. <i>Acrux</i>	Tikopai-class
NCC-1819	U.S.S. <i>Binar</i>	Tikopai-class
NCC-1820	U.S.S. <i>Einstein</i> Galactic survey cruiser with a crew of 601.	
	U.S.S. <i>Antares</i>	Tikopai-class
	Former posting of Nyota Uhura.	

NCC-1821	U.S.S. <i>Sakharov</i> Galactic survey cruiser with a crew compliment of 601.	
	U.S.S. <i>Anak</i>	Tikopai-class
NCC-1822	U.S.S. <i>Teller</i> Galactic survey cruiser with a crew compliment of 601.	
	U.S.S. <i>Betelgeuse</i>	Tikopai-class
NCC-1823	U.S.S. <i>Fermi</i> Galactic survey cruiser with a crew compliment of 601.	
	U.S.S. <i>Lux</i>	Tikopai-class
NCC-1824	U.S.S. <i>Feynman</i> Galactic survey cruiser with a crew compliment of 601.	
	U.S.S. <i>Rigel</i>	Tikopai-class
NCC-1825	U.S.S. <i>Helios</i>	Tikopai-class
NCC-1826	U.S.S. <i>Deneb</i>	Tikopai-class
NCC-1827	U.S.S. <i>Adhara</i>	Tikopai-class
NCC-1828	U.S.S. <i>Alioth</i>	Tikopai-class
NCC-1829	U.S.S. <i>Alkaid</i>	Tikopai-class
NCC-1830	U.S.S. <i>Pacific</i> Starship that was due to be decommissioned in 2290, it was instead used by Starfleet to test an experimental protomatter weapon that later destroyed the ship.	Miranda-class
	U.S.S. <i>Alnilam</i>	Tikopai-class
NCC-1831	U.S.S. <i>Intrepid</i> One of the original twelve Constitution-class starships, the <i>Intrepid</i> was crewed entirely by Vulcans. Commanders of the vessel included Captains Spiak and T'Noy. It was destroyed by a massive space-borne amoeba entity near the Gamma 7a system in 2268.	Constitution-class
	U.S.S. <i>Arided</i>	Tikopai-class
	U.S.S. <i>Joshua Paul</i> A heavy frigate, the first vessel of her class.	Joshua Paul-class
NCC-1832	U.S.S. <i>Bellatrix</i>	Tikopai-class
NCC-1833	U.S.S. <i>Miranda</i> First starship of her class. Launched from the San Francisco Fleet Yards stardate 7996.5.	Miranda-class

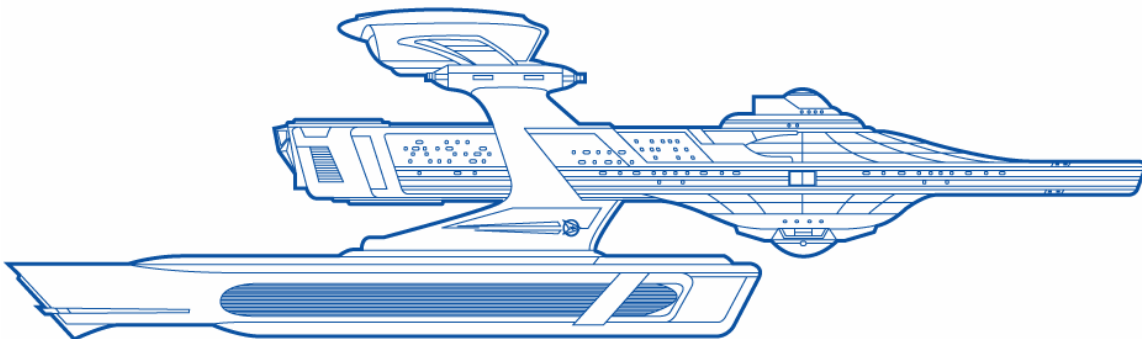

U.S.S. *Castor*

Tikopai-class

NCC-1834	U.S.S. <i>Cortez</i> Starship commanded by Captain John Stone, the <i>Cortez</i> was taken over by Vulcan colonists in 2254. Later destroyed, the <i>Cortez</i> 's shuttle #4 was named <i>Apollo</i> .	
	U.S.S. <i>Dubhe</i>	Tikopai-class
NCC-1835	U.S.S. <i>El Nath</i> Starship destroyed in 2285 when it was caught up in an accelerated time-wave emanating from the Guardian of Forever.	Tikopai-class
	U.S.S. <i>Rutheford</i>	Miranda-class
NCC-1836	U.S.S. <i>Miaplacidis</i>	Tikopai-class
NCC-1837	U.S.S. <i>Lantree</i> Commanded by Captain L. Isao Telaka, the <i>Lantree</i> was designated a Class-6 supply ship. Equipped with class-3 defensive arms, the ship's entire crew was killed by the immune system of genetically engineered children. 26 people died, and the contaminated starship was destroyed by the U.S.S. <i>Enterprise</i> NCC-1701-D to prevent further deaths.	Miranda-class
	U.S.S. <i>Mirfak</i>	Tikopai-class
NCC-1838	U.S.S. <i>Murzim</i>	Tikopai-class
NCC-1839	U.S.S. <i>Polaris</i>	Tikopai-class
NCC-1840	U.S.S. <i>Regulus</i>	Tikopai-class
NCC-1841	U.S.S. <i>Shaula</i>	Tikopai-class
NCC-1842	U.S.S. <i>Wezen</i>	Tikopai-class
NCC-1843	U.S.S. <i>Nelson</i> Former posting of Pavel Chekov.	Tikopai-class
	U.S.S. <i>Levant</i> Starship commissioned in 2290.	Constitution-class
NCC-1844	U.S.S. <i>Ticonderoga</i>	Constitution-class
NCC-1845	U.S.S. <i>Raritan</i>	Constitution-class
NCC-1846	U.S.S. <i>Temeraire</i>	Constitution-class
NCC-1847	U.S.S. <i>America</i>	Constitution-class
NCC-1848	U.S.S. <i>Scipion</i>	Constitution-class
NCC-1849	U.S.S. <i>Alliance</i>	Constitution-class
NCC-1850	U.S.S. <i>Surya</i> First starship of her class, a frigate.	Surya-class

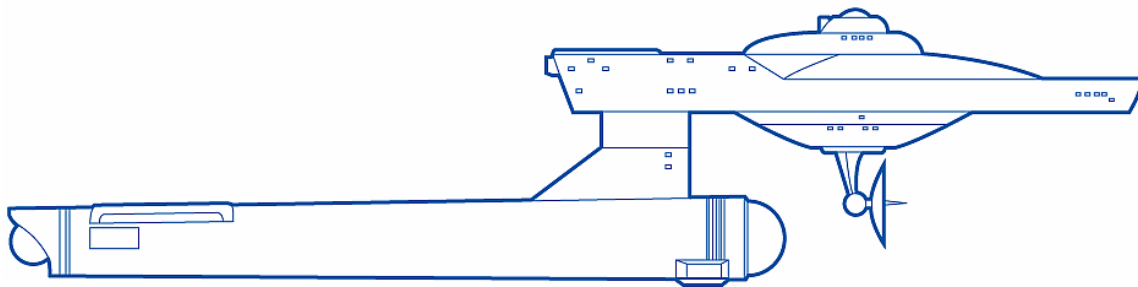

	U.S.S. <i>Hippocrates</i>	Hippocrates-class
	First starship of her class, a medical frigate with a crew complement of 425. Weighing 170,000 metric tons, the ship has twenty-five percent of its volume dedicated to lab facilities. It is 236m long, 141.7m wide and 53m high.	
NCC-1851	U.S.S. <i>Illusive</i>	
NCC-1852	U.S.S. <i>Antrim</i>	
NCC-1853	U.S.S. <i>Durmitov</i>	Surya-class

NCC-1854	U.S.S. <i>Kanaris</i>	
NCC-1855	U.S.S. <i>Pralaya</i>	
NCC-1856	U.S.S. <i>Emden</i>	
	Vessel on Neutral Zone patrol on stardate 9521.	
	U.S.S. <i>Hashira</i>	
NCC-1857	U.S.S. <i>Andalucia</i>	Surya-class
NCC-1858	U.S.S. <i>Brilliant</i>	Surya-class
	U.S.S. <i>Ashanti</i>	Ashanti-class
	Heavy frigate, the first ship of her class, commissioned in 2267. 212.7m long, 75.5m wide and 33.5m high, the ship had a crew of 340.	
NCC-1859	U.S.S. <i>Thetis</i>	Surya-class
NCC-1860	U.S.S. <i>Avenger</i>	Avenger-class
	First vessel of her class, similar in size and configuration to the Miranda-class. Launched in 2247.	
	U.S.S. <i>Endeavour</i>	Endeavor-class
	Pathfinder vessel of her class.	
	U.S.S. <i>Bantu</i>	Ashanti-class
NCC-1861	U.S.S. <i>Courageous</i>	Soyuz-class
NCC-1862	U.S.S. <i>Endurance</i>	Endurance-class
	First starship of her class, designated a frigate.	
	U.S.S. <i>Bolivar</i>	Miranda-class
NCC-1863	U.S.S. <i>Repulse</i>	Miranda-class
	U.S.S. <i>Illustrious</i>	
NCC-1864	U.S.S. <i>Reliant</i>	Miranda-class
	Starship commanded by Captain Clark Terell, Pavel Chekov was the ship's first officer. It was destroyed in 2285 at the Mutara Nebula after being commandeered by Khan Noonien Singh and his genetic 'supermen'.	
NCC-1865	U.S.S. <i>Yoruba</i>	Ashanti-class
	U.S.S. <i>Vigilant</i>	
NCC-1866	U.S.S. <i>Dromio</i>	
	U.S.S. <i>Condor</i>	Miranda-class
NCC-1867	U.S.S. <i>Saratoga</i>	Miranda-class
	U.S.S. <i>Balthasar</i>	
NCC-1868	U.S.S. <i>Ardana</i>	
NCC-1869	U.S.S. <i>Gallant</i>	Miranda-class
	U.S.S. <i>Amiens</i>	Miranda-class
NCC-1870	U.S.S. <i>Renown</i>	Miranda-class
	U.S.S. <i>Antipholus</i>	Avenger-class
NCC-1871	U.S.S. <i>Invincible</i>	Miranda-class
	U.S.S. <i>Dardanius</i>	
NCC-1872	U.S.S. <i>Daring</i>	Miranda-class
	U.S.S. <i>Hippolyta</i>	
NCC-1873	U.S.S. <i>Devastator</i>	Miranda-class
	U.S.S. <i>Melkotia</i>	
NCC-1874	U.S.S. <i>Courage</i>	Miranda-class
	U.S.S. <i>Sarpeidon</i>	
NCC-1875	U.S.S. <i>Odin</i>	
NCC-1876	U.S.S. <i>Nar-Tak Shir</i>	

NCC-1877	U.S.S. <i>Resolution</i>	Avenger-class
NCC-1878	U.S.S. <i>Polonius</i>	Avenger-class
NCC-1879	U.S.S. <i>Yonada</i>	
NCC-1880	U.S.S. <i>Oberon</i>	Miranda-class
	U.S.S. <i>Bolivar</i>	Bolivar-class
	Light cruiser, the first vessel of her class. Launched in 2264 from the Copernicus Fleet Yards, the ship was 198m long, 146m wide, 58m high and had a crew compliment of 296.	
	U.S.S. <i>Malawi</i>	Ashanti-class
	Starship lost in 2275.	
NCC-1881	U.S.S. <i>Alacrity</i>	
NCC-1882	U.S.S. <i>Shiva</i>	Surya-class
NCC-1883	U.S.S. <i>Regent</i>	Surya-class
NCC-1884	U.S.S. <i>Spiro</i>	Surya-class
NCC-1885	U.S.S. <i>Noshiro</i>	Surya-class
NCC-1886	U.S.S. <i>Ardent</i>	
NCC-1887	U.S.S. <i>Niovi</i>	Surya-class
NCC-1888	U.S.S. <i>Argus</i>	
NCC-1889	U.S.S. <i>Bir Hakeim</i>	Surya-class
NCC-1890	U.S.S. <i>Cyane</i>	Cyane-class
	First starship of her class, designated a heavy frigate.	
	U.S.S. <i>Rickover</i>	Rickover-class
	First starship of her class, a fast frigate. Intended as a frigate version of a dreadnought, it has three nacelles. Crewed by 425 people, it weighed 191,000 metric tones and was armed with two megaphaser turrets, 6 phaser banks and 4 photon torpedo tubes. The vessel was 141.7 wide, 236m long and 75m high.	
NCC-1891	U.S.S. <i>Repose</i>	
NCC-1892	U.S.S. <i>Balthasar</i>	Cyane-class
	U.S.S. <i>Saratoga</i>	
NCC-1893	U.S.S. <i>Tecumseh</i>	Cyane-class
NCC-1894	U.S.S. <i>Savannah</i>	Cyane-class
NCC-1895	U.S.S. <i>Endeavour</i>	Constitution-class
	Starship assigned to deep-space exploration as of stardate 9521.	
	U.S.S. <i>Constellation</i>	Cyane-class
NCC-1896	U.S.S. <i>Reprisal</i>	Cyane-class
NCC-1897	U.S.S. <i>Toresta</i>	Cyane-class
NCC-1898	U.S.S. <i>Sumter</i>	Cyane-class
NCC-1899	U.S.S. <i>Auguste</i>	Cyane-class

NCC-1900

U.S.S. *Benning* Benning-class
Frigate-type vessel, first of her class.
U.S.S. *Hook* Hook-class
Starship, first of her class.

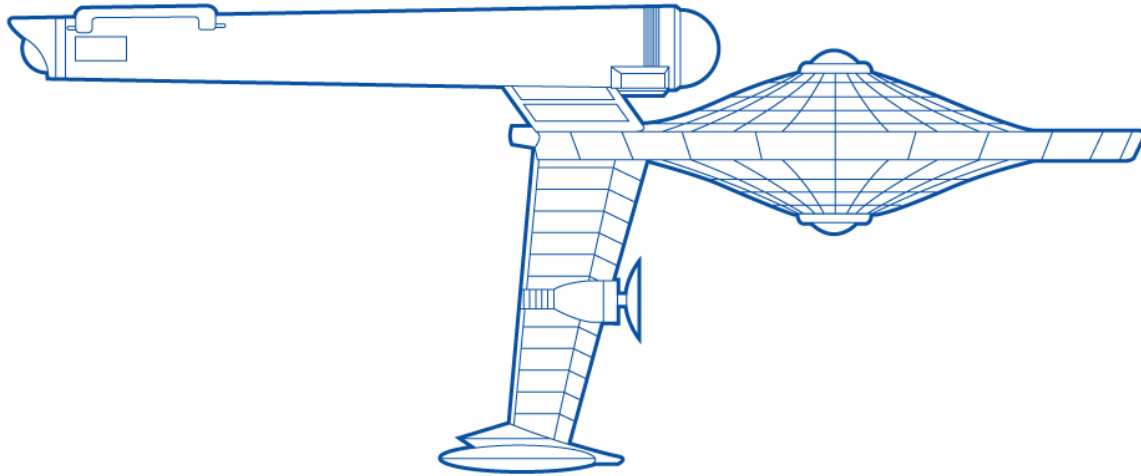

NCC-1901

U.S.S. *Leavenworth* Leavenworth-class
First vessel of her class, a frigate.

NCC-1903

U.S.S. *Zimbabwe* Ashanti-class
Vessel that rescued the survivors of the Kebris III disaster in 2283.

NCC-1913

U.S.S. *Mistral* Bolivar-class

NCC-1915

U.S.S. *Langley* Leavenworth-class

NCC-1925

U.S.S. *Santee* Santee-class
Prototype vessel of her class, an escort-cruiser.

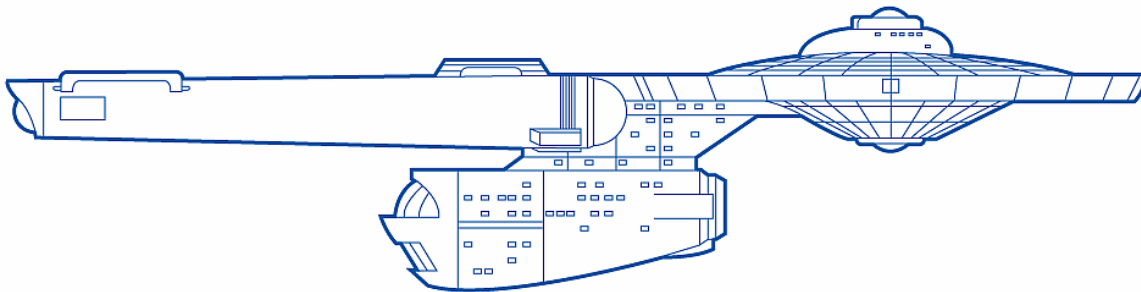

NX-1927

U.S.S. *Sparta* Sparta-class
Pathfinder vessel of the class. Launched in 2276, it served Starfleet for 42 years, when it was decommissioned due to having suffered a hull breach. The ship retained an NX- prefix for the entire duration of its service. A heavy cruiser, it was 281m long, 189m wide, 80m high, with a crew of 410. The ship had four warp nacelles.

NCC-1928

U.S.S. *Suwannee* Santee-class

NCC-1934

U.S.S. *Dublin* Bolivar-class

NCC-1935

U.S.S. *Stargazer* Stargazer-class

First starship of her class, designated an exploratory cruiser.

NCC-1936

U.S.S. *Peregrine* Peregrine-class

Starship, the first and only vessel of her class, a frigate. Designed to mimic certain design features of Romulan vessels, the ship was built up from a finished Miranda-class hull.

- NCC-1937 U.S.S. *Saratoga* Miranda-class
Starship commanded by Captain Alexander in 2286 when it was temporarily disabled by the “Whale Probe”.
- NCC-1938 U.S.S. *Coral Sea* Coral Sea-class
Battleship, the first vessel of her class.
- NCC-1939 U.S.S. *Soyuz* Soyuz-class
First vessel of her class, 243m long.

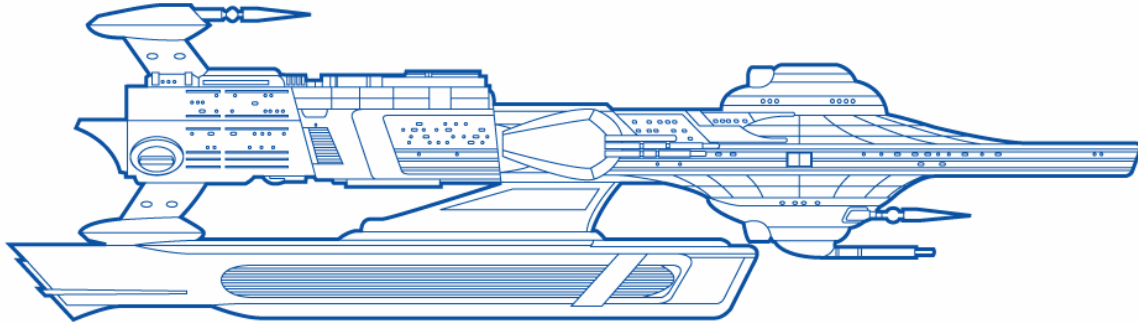

- NCC-1940 U.S.S. *Knox* Knox-class
First vessel of her class, designated a frigate.
- NCC-1941 U.S.S. *Bozeman* Soyuz-class
Starship under the command of Captain Morgan Bateson, the ship was three weeks out of Starbase 12 when it traveled through a temporal causality loop from 2278 to the year 2368. The ship was later decommissioned and remained at Starbase 12 as a museum ship.
- NCC-1941-A U.S.S. *Bir Hakeim*
U.S.S. *Bozeman*
The newest *Bozeman* was launched in 2272 under the command of Captain Morgan Bateson. Built at Starbase 12, it was to have originally been named U.S.S. *Roderick*.
- NCC-1942 U.S.S. *Seneschal* Knox-class
- NCC-1943 U.S.S. *Enhance* Knox-class
- NCC-1944 U.S.S. *Asturias* Knox-class
- NCC-1945 U.S.S. *Kiri* Knox-class
- NCC-1946 U.S.S. *Opportune* Knox-class
- NCC-1947 U.S.S. *Sivrihisar* Knox-class
- NCC-1948 U.S.S. *Le Malin* Knox-class
- NCC-1949 U.S.S. *Thach* Knox-class
- NCC-1950 U.S.S. *Springeren* Knox-class
U.S.S. *Pruitt* Oriskany-class
- NCC-1951 U.S.S. *Nimitz*
Strike carrier with a crew complement of 459. It's assigned escort vessel was the U.S.S. *Halsey*, NCC-565.
U.S.S. *Cassiopee* Knox-class
U.S.S. *Kinnebrew* Oriskany-class
- NCC-1952 U.S.S. *Yamamoto*
Strike carrier with a crew of 459. It's assigned escort was the U.S.S. *Nagumo* NCC-566.
U.S.S. *Kaya* Knox-class
U.S.S. *Dauphinais* Oriskany-class

NCC-1953	U.S.S. <i>Nelson</i> Strike carrier with a crew compliment of 459.	
	U.S.S. <i>Ability</i>	Knox-class
	U.S.S. <i>Katarina</i>	Oriskany-class
NCC-1954	U.S.S. <i>Gordhkob</i> Strike carrier with a crew compliment of 459.	
	U.S.S. <i>Pico</i>	Knox-class
	U.S.S. <i>Mueller</i>	Oriskany-class
NCC-1955	U.S.S. <i>Raeder</i> Strike carrier with a crew of 459.	
	U.S.S. <i>Incharron</i>	Knox-class
	U.S.S. <i>Sceto</i>	Oriskany-class
NCC-1956	U.S.S. <i>Houston</i> Strike carrier with a crew of 459.	
	U.S.S. <i>Diligence</i>	Knox-class
	U.S.S. <i>Windsor</i>	Oriskany-class
NCC-1957	U.S.S. <i>Atrevida</i>	Knox-class
	U.S.S. <i>Quinten</i>	Oriskany-class
NCC-1958	U.S.S. <i>Swift</i>	Knox-class
	U.S.S. <i>Zabell</i>	Oriskany-class
NCC-1959	U.S.S. <i>Peleliu</i>	
	U.S.S. <i>Yourich</i>	Oriskany-class
NCC-1960	U.S.S. <i>Matapan</i>	Knox-class
	U.S.S. <i>Escriba</i>	Oriskany-class
NCC-1961	U.S.S. <i>Espadon</i>	Knox-class
	U.S.S. <i>Lawton</i>	Oriskany-class
NCC-1962	U.S.S. <i>Skate</i>	Knox-class
	U.S.S. <i>Forbus</i>	Oriskany-class
NCC-1963	U.S.S. <i>Springfield</i> Starship assigned to Neutral Zone patrol as of stardate 9521.	
	U.S.S. <i>Miramichi</i>	Knox-class
	U.S.S. <i>Lechner</i>	Oriskany-class
NCC-1964	U.S.S. <i>Utsira</i>	Knox-class
	U.S.S. <i>Kincaid</i>	Oriskany-class
NCC-1965	U.S.S. <i>Carron</i>	
	U.S.S. <i>Young</i>	Oriskany-class
NCC-1966	U.S.S. <i>Rithmire</i>	Oriskany-class
	U.S.S. <i>Kresta</i>	Kresta-class
	First starship of her class, a heavy frigate.	
	U.S.S. <i>Valhalla</i>	
NCC-1967	U.S.S. <i>Smartt</i>	Oriskany-class
	U.S.S. <i>Uselton</i>	Kresta-class
	U.S.S. <i>Stonehenge</i>	Bolivar-class
NCC-1968	U.S.S. <i>Labrynth</i>	Oriskany-class
	U.S.S. <i>Deitrich</i>	Kresta-class
	U.S.S. <i>Calypso</i>	Bolivar-class

NCC-1969	U.S.S. <i>Chelsea</i> U.S.S. <i>Moreno</i> U.S.S. <i>Sea Lion</i>	Oriskany-class Kresta-class Bolivar-class
NCC-1970	U.S.S. <i>Drago</i> U.S.S. <i>Howerton</i> U.S.S. <i>Tolstoy</i>	Oriskany-class Kresta-class Bolivar-class
NCC-1971	U.S.S. <i>Carlat</i> U.S.S. <i>Cramblit</i> U.S.S. <i>Teheran</i>	Oriskany-class Kresta-class Bolivar-class
NCC-1972	U.S.S. <i>Krile</i> U.S.S. <i>Misha</i>	Oriskany-class Kresta-class
NCC-1973	U.S.S. <i>Solter</i> U.S.S. <i>Irby</i>	Oriskany-class Kresta-class
NCC-1974	U.S.S. <i>Constellation</i>	Constellation-class

Pathfinder of her class, originally registered NX-1974. On stardate 9521, the ship was undergoing certification tests at Starbase 24. On stardate 51408.6 the *Constellation* was ordered to search for survivors of the *starship Honshu*. The ship was 310m long and had 15 decks, with a crew compliment of 535.

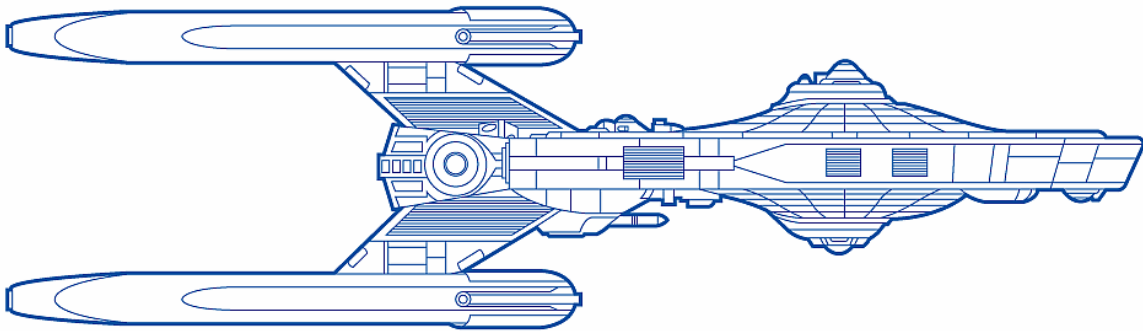

NCC-1975	U.S.S. <i>Coronado</i> U.S.S. <i>Ranger</i> Commanded by Captain Amanda Sheldon.	Coronado-class Miranda-class
NCC-1976	U.S.S. <i>Oriskany</i>	Oriskany-class
NCC-1977	U.S.S. <i>Clemenceau</i>	Oriskany-class
NCC-1978	U.S.S. <i>Exultant</i> First vessel of her class, a frigate. Crewed by 370 persons, it was armed with two megaphaser emplacements and six dualphaser banks. The ship was 258.7m long, 141.7m wide and 49.9m high.	Exultant-class
NCC-1979	U.S.S. <i>Bennington</i> U.S.S. <i>Devonshire</i>	Coronado-class
NCC-1980	U.S.S. <i>Kiev</i>	
NCC-1981	U.S.S. <i>Advance</i> First starship of her class, a thru-deck carrier.	Advance-class
NCC-1982	U.S.S. <i>Ebrew</i> U.S.S. <i>Phinias</i>	Oriskany-class
NCC-1983	U.S.S. <i>Tarina</i> U.S.S. <i>Adroit</i>	Advance-class

NCC-1984	U.S.S. <i>Ueller</i>	
	U.S.S. <i>Accent</i>	Advance-class
NCC-1986	U.S.S. <i>Adamant</i>	Advance-class
NCC-1990	U.S.S. <i>Hook</i>	Hook-class
	Pathfinder vessel of her class, a cruiser.	
	U.S.S. <i>Recovery</i>	Recovery-class
	Starship, first vessel of her class.	
NCC-1995	U.S.S. <i>Siegen</i>	Bolivar-class
NCC-1996	U.S.S. <i>Laura Reinecke</i>	
	Starship renown for its instrumental involvement in the Ceti IV incident, it was commanded by Captain Uazuri Mgumi.	
	U.S.S. <i>Kilimanjaro</i>	Bolivar-class
NCC-1997	U.S.S. <i>Cartagena</i>	Bolivar-class
NCC-1998	U.S.S. <i>Scientia</i>	Bolivar-class
NCC-2000	U.S.S. <i>Excelsior</i>	Excelsior-class
	Pathfinder vessel of one of the Fleet's most durable vessel classes. Launched from the San Francisco Fleet Yards on stardate 8205.5, it was originally designated NX-2000. The ship was a tested for the experimental transwarp drive and was later fitted with standard, though up rated, warp drive. 467m long and having 35 decks, the ship's first commander was Captain Styles. He was replaced by Hikaru Sulu in 2290. It had a crew compliment of 770 and bore the motto "No matter where you go, there you are."	

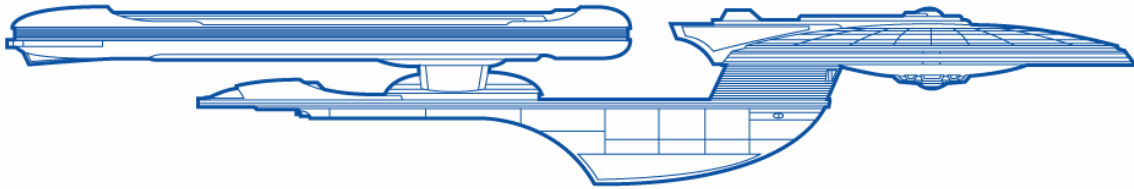

	U.S.S. <i>Hatfield</i>	Hatfield-class
	First vessel of her class, designated a command cruiser.	
NCC-2001	U.S.S. <i>Ingram</i>	Ingram-class
	First starship of her class, a technological advancement to the Excelsior-class.	
	U.S.S. <i>Proxima</i>	Excelsior-class
	U.S.S. <i>Discovery</i>	
	Scout cruiser with a crew compliment of 361.	
	U.S.S. <i>McCoy</i>	Hatfield-class
NCC-2002	U.S.S. <i>Columbia</i>	Excelsior-class
	U.S.S. <i>Transeifer</i>	Hatfield-class
	U.S.S. <i>Santa Maria</i>	
	Scout cruiser with a crew of 361.	
NCC-2003	U.S.S. <i>Inaieu</i>	Defender-class.
	Built at the Starfleet Shipyards at Deneb, the <i>Inaieu</i> was commanded by Captain Nhauris Rihaul. Classified a heavy destroyer, the ship had three times the standard armament of a Constitution-class ship and boasted four warp nacelles.	
	U.S.S. <i>Galacta</i>	Excelsior-class
	U.S.S. <i>Calypso</i>	
	Scout cruiser with a crew compliment of 361.	
	U.S.S. <i>Coulton</i>	Hatfield-class

NCC-2004	U.S.S. <i>Excalibur</i>	Excelsior-class
	U.S.S. <i>Pedroso</i>	Hatfield-class
	U.S.S. <i>Crockett</i>	

Scout cruiser with a crew compliment of 361.

NCC-2005	U.S.S. <i>Sydney</i>	Sydney-class
	Pathfinder vessel of her class, a transport vessel.	

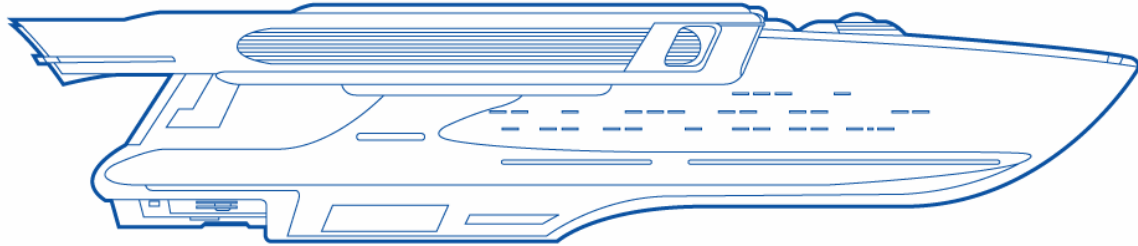

	U.S.S. <i>Hancock</i>	Excelsior-class
	U.S.S. <i>Zaider</i>	Hatfield-class
	U.S.S. <i>Pendragon</i>	

NCC-2006	U.S.S. <i>Potemkin</i>	Excelsior-class
	U.S.S. <i>Silencio</i>	Hatfield-class

NCC-2007	U.S.S. <i>Kitty Hawk</i>	Excelsior-class
	U.S.S. <i>Lyon</i>	Hatfield-class

NCC-2008	U.S.S. <i>Chikuma</i>	Excelsior-class
	U.S.S. <i>Biggler</i>	Hatfield-class

NCC-2009	U.S.S. <i>Kongo</i>	Excelsior-class
	U.S.S. <i>Henderson</i>	Hatfield-class

NCC-2010	U.S.S. <i>Jenolan</i>	Sydney-class
----------	-----------------------	--------------

Transport vessel under the command of Captain James Armstrong, it was on course for the Norpin V colony when it crashed on a Dyson sphere in 2294. Montgomery Scott , a passenger, saved himself and attempted to save another in a transporter buffer, where he remained until rescued by the U.S.S. *Enterprise* NCC-1701-D in 2369.

	U.S.S. <i>Ajax</i>	Excelsior-class
	U.S.S. <i>Nazarek</i>	Hatfield-class
NCC-2011	U.S.S. <i>Achilles</i>	Excelsior-class
	U.S.S. <i>Sundburg</i>	Hatfield-class

NCC-2012	U.S.S. <i>Arizona</i>	Excelsior-class
	U.S.S. <i>Red October</i>	Excelsior-class

Starship commissioned stardate 9311.7 with the motto "*They will tremble at the sound of our silence.*" It was commanded by Admiral Todd M. Pletz.

	U.S.S. <i>Mauston</i>	Hatfield-class
NCC-2013	U.S.S. <i>Royal Oak</i>	Excelsior-class
	U.S.S. <i>Krackel</i>	Hatfield-class

NCC-2014	U.S.S. <i>Korolev</i>	
	Ship assigned to a diplomatic mission as of stardate 9521.	

	U.S.S. <i>Agincourt</i>	Excelsior-class
	U.S.S. <i>Rusk</i>	Hatfield-class
NCC-2015	U.S.S. <i>Yamashiro</i>	Excelsior-class
	U.S.S. <i>Archive</i>	Hatfield-class

NCC-2016	U.S.S. <i>Exeter</i>	Excelsior-class
	U.S.S. <i>Tuten</i>	Hatfield-class
NCC-2017	U.S.S. <i>Hood</i>	Excelsior-class
	U.S.S. <i>Quire</i>	Hatfield-class
	U.S.S. <i>Retribution</i>	Excelsior-class
NCC-2018	U.S.S. <i>Valiant</i>	Excelsior-class
	U.S.S. <i>Justice</i>	Hatfield-class
NCC-2019	U.S.S. <i>Fuso</i>	Excelsior-class
	U.S.S. <i>Cendra</i>	Hatfield-class
NCC-2020	U.S.S. <i>Intrepid</i>	Excelsior-class
	U.S.S. <i>Lukert</i>	Hatfield-class
NCC-2021	U.S.S. <i>Farragut</i>	Excelsior-class
NCC-2022	U.S.S. <i>Ryujo</i>	Excelsior-class
NCC-2023	U.S.S. <i>Challenger</i>	Excelsior-class
NCC-2024	U.S.S. <i>Sussex</i>	Excelsior-class
NCC-2025	U.S.S. <i>Constitution</i>	Excelsior-class
NCC-2026	U.S.S. <i>Lexington</i>	Excelsior-class
NCC-2027	U.S.S. <i>Bearn</i>	Excelsior-class
	U.S.S. <i>Wildfire</i>	Hatfield-class
NCC-2028	U.S.S. <i>Aquila</i>	Excelsior-class
NCC-2029	U.S.S. <i>De Mayo</i>	Excelsior-class
NCC-2030	U.S.S. <i>Brisbane</i>	Excelsior-class
	U.S.S. <i>Roosevelt</i>	Roosevelt-class
	First starship of her class, a light cruiser. Launched in 2281, it was crewed by 239 persons. The ship was 202m long, 79m wide and 59m high.	
NCC-2031	U.S.S. <i>Eagle</i>	Excelsior-class
NCC-2032	U.S.S. <i>Challenger</i>	Challenger-class
	The first vessel of her class, an exploratory cruiser. It was assigned to deep-space exploration as of stardate 9521.	
	U.S.S. <i>Thunderer</i>	Excelsior-class
NCC-2033	U.S.S. <i>Yorktown</i>	Excelsior-class
NCC-2034	U.S.S. <i>Ticonderoga</i>	Excelsior-class
NCC-2035	U.S.S. <i>Alamo</i>	Excelsior-class
NCC-2036	U.S.S. <i>Fearless</i>	Excelsior-class
NCC-2037	U.S.S. <i>Republic</i>	Excelsior-class
NCC-2042	U.S.S. <i>Athens</i>	Excelsior-class
NCC-2048	U.S.S. <i>Ahwahnee</i>	
	Starship assigned to deep-space exploration as of stardate 9521.	
NCC-2049	U.S.S. <i>Ulster</i>	Roosevelt-class
NCC-2050	U.S.S. <i>Yokohama</i>	Roosevelt-class
NCC-2051	U.S.S. <i>Principium</i>	Excelsior-class
NCC-2053	U.S.S. <i>Valorous</i>	Excelsior-class
NCC-2069	U.S.S. <i>Begdar Ser</i>	Excelsior-class
NCC-2097	U.S.S. <i>Yokohama</i>	

NCC-2100

U.S.S. *Federation*

Federation-class

Pathfinder vessel of her class, the *Federation* was 320m long, 140m wide and 87m high. Classified a dreadnought, it had three warp nacelles.

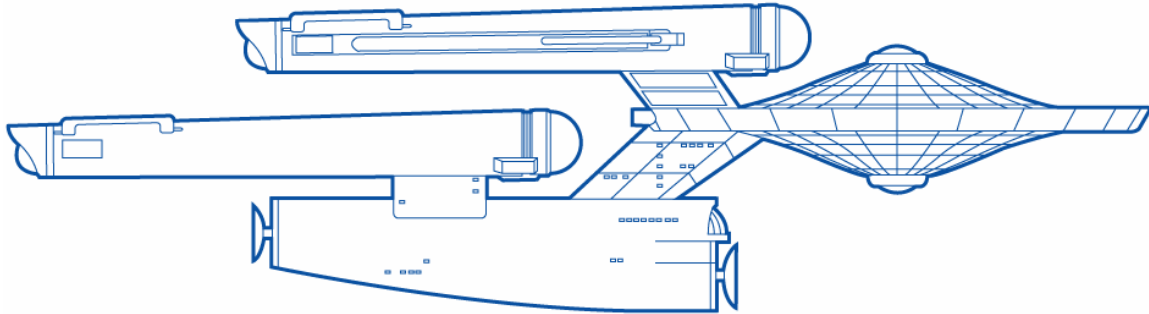

NCC-2101

U.S.S. *Star League*

Star League-class

NCC-2102

U.S.S. *Unificatum*

Federation-class

NCC-2103

U.S.S. *Compactat*

Federation-class

NCC-2104

U.S.S. *Corporation*

Federation-class

NCC-2105

U.S.S. *Archangelese*

Federation-class

U.S.S. *Balson*

Balson-class

First vessel of her class, considered a command ship.

NCC-2106

U.S.S. *Konkordium*

Federation-class

Starship in dry-dock at starbase 7 on stardate 4720.

NCC-2107

U.S.S. *Star System*

Federation-class

NCC-2108

U.S.S. *Affiliation*

Federation-class

NCC-2109

U.S.S. *Concordat*

Federation-class

NCC-2110

U.S.S. *Directorate*

Federation-class

NCC-2111

U.S.S. *Organization*

Federation-class

NCC-2112

U.S.S. *Sabre*

Caesar-class

Heavy cruiser built at the Utopia Planitia Fleet Yards. It's motto was "*Storm'd at with shot and shell. Boldly they rode and well, Into the jaws of Death, Into the mouth of Hell.*"

U.S.S. *Star Union*

Federation-class

NCC-2113

U.S.S. *Alliance*

Federation-class

NCC-2114

U.S.S. *Confederation*

Federation-class

NCC-2115

U.S.S. *Dominion*

Federation-class

Starship in dry-dock at starbase 7 on stardate 4720.

U.S.S. *Sutherland*

Bolivar-class

NCC-2115-A

U.S.S. *Dominion*

NCC-2115-B

U.S.S. *Dominion*

Republic-class

NCC-2116

U.S.S. *Star Empire*

Federation-class

NCC-2117

U.S.S. *Trusteeship*

Federation-class

U.S.S. *Star Stalker*

Star Stalker-class

First vessel of her class, a patrol cruiser.

NCC-2118

U.S.S. *Association*

Federation-class

NCC-2119

U.S.S. *Consortium*

Federation-class

NCC-2120

U.S.S. *Entente*

Federation-class

U.S.S. *Star Ranger*

Star Ranger-class

Prototype of her class, a dreadnought.

NCC-2121

U.S.S. *Pact*

Balson-class

NCC-2122	U.S.S. <i>Territory</i>	Balson-class
NCC-2123	U.S.S. <i>Formality</i>	Balson-class
NCC-2130	U.S.S. <i>Soryu</i> Starship, the first of her class, a though-deck cruiser.	Soryu-class
NCC-2131	U.S.S. <i>Etna</i> First starship of her class, designated a command ship.	Etna-class
NCC-2143	U.S.S. <i>Confederation</i>	
NCC-2143-A	U.S.S. <i>Confederation</i>	
NCC-2143-B	U.S.S. <i>Confederation</i>	Nichter-class
NCC-2150	U.S.S. <i>Kirov</i> First starship of her class, a dreadnought.	Kirov-class
NCC-2151	U.S.S. <i>Excalibur</i>	
NCC-2152	U.S.S. <i>Mars</i>	Federation-class
NCC-2153	U.S.S. <i>Nebu</i>	Federation-class
NCC-2183	U.S.S. <i>Neptune</i>	Bolivar-class
NCC-2191	U.S.S. <i>Triumph</i> Classified by Starfleet as a 'light dreadnought.'	
NCC-2200	U.S.S. <i>Ariel</i> First starship of her class, designated a shuttle-carrier.	Ariel-class
	U.S.S. <i>Napoleon</i> First vessel of her class, originally a heavy carrier. With a crew compliment of 493. After being heavily damaged, the ship underwent a conversion to a space control vessel with a new crew compliment of 549. The ship was later destroyed.	Napoleon-class
	U.S.S. <i>Crusader</i> First starship of her class, a battleship.	Crusader-class
NCC-2201	U.S.S. <i>MacArthur</i> Heavy carrier with a crew of 493. Escorts for her included the U.S.S. <i>Patton</i> NCC-956 and the U.S.S. <i>Wainwright</i> NCC-1545.	
	U.S.S. <i>Ichkeul</i>	Ariel-class
NCC-2202	U.S.S. <i>Zhukov</i> Heavy carrier of 493. It's escort vessel was the U.S.S. <i>Koniev</i> NCC-961.	
	U.S.S. <i>Manna</i>	Ariel-class
NCC-2203	U.S.S. <i>Julius Caesar</i> Originally intended as a heavy carrier, the <i>Caesar</i> was instead completed as a space control vessel with a crew of 549. It was later destroyed in battle.	
	U.S.S. <i>Adjuvant</i>	Ariel-class
NCC-2204	U.S.S. <i>Fredrikstad</i> First vessel of her class, the prototype was designated a shuttle carrier.	Fredrikstad-class
	U.S.S. <i>George Washington</i> Space control vessel with a crew compliment of 549. Upon it's retirement, the <i>George Washington</i> became a museum ship.	
NCC-2205	U.S.S. <i>Malverne</i>	Fredrikstad-class
	U.S.S. <i>Frederick the Great</i> Space control vessel with a crew of 549.	
NCC-2215	U.S.S. <i>Jenshahn</i> Prototype vessel of her class, a shuttle carrier.	Jenshahn-class
NCC-2250	U.S.S. <i>Harrier</i>	Federation-class

NCC-2252	U.S.S. <i>Valiant</i> A light cruiser.	
	U.S.S. <i>Tyrant</i>	Federation-class
NCC-2254	U.S.S. <i>Kali</i>	Federation-class
NCC-2257	U.S.S. <i>Agamemnon</i>	Federation-class
NCC-2259	U.S.S. <i>Venture</i>	
NCC-2260	U.S.S. <i>Valiant</i>	Roosevelt-class
NCC-2261	U.S.S. <i>Frontenac</i>	Roosevelt-class
NCC-2262	U.S.S. <i>Fearless</i>	Roosevelt-class
NCC-2263	U.S.S. <i>Archangel</i> Starship, first vessel of her class, a shuttle carrier.	Archangel-class
	U.S.S. <i>Bennington</i> Thru-deck carrier, first of her class.	Bennington-class
NCC-2294	U.S.S. <i>Archangel</i> Prototype vessel of her class, considered a shuttle carrier.	Archangel-class
NCC-2296	U.S.S. <i>Matrix</i>	
NCC-2300	U.S.S. <i>Chandley</i> Prototype frigate, first of her class.	Chandley-class

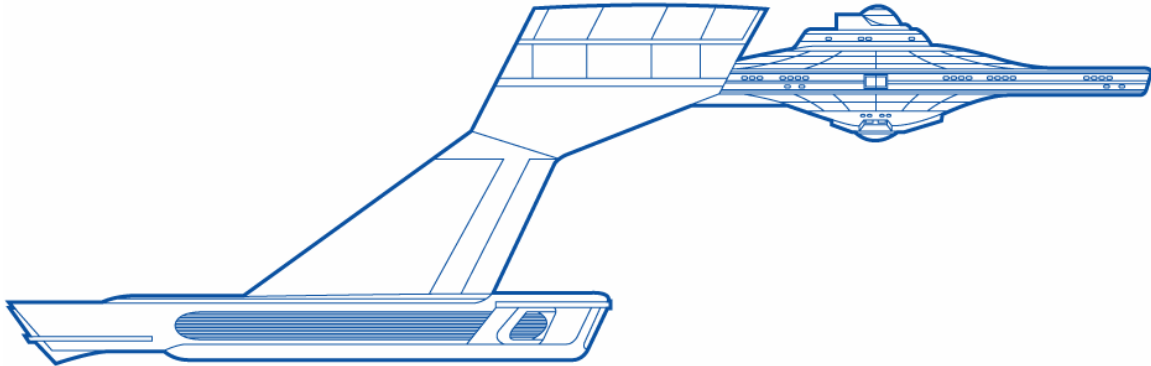

NCC-2309	U.S.S. <i>Hanson</i>	Chandley-class
NCC-2327	U.S.S. <i>Blackheart</i>	Chandley-class
NCC-2346	U.S.S. <i>Dupleix</i> First vessel of her class, a perimeter-action vessel.	Dupleix-class
NCC-2349	U.S.S. <i>Bismarck</i>	
NCC-2360	U.S.S. <i>Vanguard</i> Starship commanded by Captain Gythia North	
NCC-2363	U.S.S. <i>Repulse</i>	
NCC-2370	U.S.S. <i>Furious</i> Starship, the first of her class, designated a cruiser. Launched in October of 2296. With a crew compliment of 339, the ship was 246.1m long, 111.2m wide and 37.4m high, and displaced 158,720 tones.	Furious-class
NCC-2371	U.S.S. <i>Glorious</i>	Furious-class
	U.S.S. <i>Alacrity</i> Starship, the first of five vessels in the class, designated a Command and Control Vessel.	Alacrity-class
NCC-2372	U.S.S. <i>Horrible</i>	Furious-class
NCC-2373	U.S.S. <i>Merciless</i>	Furious-class
NCC-2374	U.S.S. <i>Relentless</i>	Furious-class
NCC-2375	U.S.S. <i>Terrible</i>	Furious-class

NCC-2376	U.S.S. <i>Savage</i>	Furious-class
NCC-2377	U.S.S. <i>Spiteful</i>	Furious-class
NCC-2378	U.S.S. <i>Audacious</i>	Furious-class
NCC-2379	U.S.S. <i>Dauntless</i>	Furious-class
NCC-2380	U.S.S. <i>Majestic</i>	Furious-class
NCC-2381	U.S.S. <i>Swiftsure</i>	Furious-class
	U.S.S. <i>Kaga</i>	
	A heavy cruiser.	
NCC-2382	U.S.S. <i>Sir Richard</i>	
	Starship commanded by Captain Nick Farey.	
	U.S.S. <i>Superb</i>	Furious-class
NCC-2383	U.S.S. <i>Peerless</i>	Furious-class
NCC-2384	U.S.S. <i>Courageous</i>	Furious-class
NCC-2385	U.S.S. <i>Invincible</i>	Furious-class
NCC-2386	U.S.S. <i>Inflexible</i>	Furious-class
NCC-2387	U.S.S. <i>Brilliant</i>	Furious-class
NCC-2388	U.S.S. <i>Triumphant</i>	Furious-class
NCC-2389	U.S.S. <i>Vigilant</i>	Furious-class
NCC-2390	U.S.S. <i>Resolute</i>	Furious-class
NCC-2391	U.S.S. <i>Splendid</i>	Furious-class
NCC-2392	U.S.S. <i>Monson</i>	Chandley-class
	U.S.S. <i>Vengeful</i>	Furious-class
NCC-2393	U.S.S. <i>Formidable</i>	Furious-class
NCC-2394	U.S.S. <i>Daring</i>	Daring-class
	First vessel of her class, a surveillance corvette.	
	U.S.S. <i>Indomitable</i>	Furious-class
NCC-2395	U.S.S. <i>Tenacious</i>	Furious-class
NCC-2400	U.S.S. <i>Podesti</i>	Podesti-class
	First vessel of her class, classified as a cruiser.	
NCC-2401	U.S.S. <i>Passerio</i>	Podesti-class
NCC-2402	U.S.S. <i>Dolton</i>	Podesti-class
NCC-2403	U.S.S. <i>Naumann</i>	Podesti-class
NCC-2404	U.S.S. <i>Funghi</i>	Podesti-class
NCC-2405	U.S.S. <i>Howden</i>	Podesti-class
NCC-2406	U.S.S. <i>Zendeler</i>	Podesti-class
NCC-2407	U.S.S. <i>Rhett</i>	Podesti-class
NCC-2408	U.S.S. <i>Butler</i>	Podesti-class
NCC-2409	U.S.S. <i>Dixon</i>	Podesti-class
NCC-2410	U.S.S. <i>Elliott</i>	Podesti-class
NCC-2411	U.S.S. <i>Abreu</i>	Podesti-class
NCC-2412	U.S.S. <i>Ledyar</i>	Podesti-class
NCC-2413	U.S.S. <i>Woodall</i>	Podesti-class
NCC-2414	U.S.S. <i>Tanner</i>	Podesti-class
NCC-2415	U.S.S. <i>Juerjensen</i>	Podesti-class
NCC-2416	U.S.S. <i>Hawkling</i>	Podesti-class
NCC-2417	U.S.S. <i>Bohn</i>	Podesti-class
NCC-2418	U.S.S. <i>Newport</i>	Podesti-class

NCC-2419	U.S.S. <i>Wilkie</i>	Podesti-class
NCC-2420	U.S.S. <i>Booth</i>	Podesti-class
NCC-2421	U.S.S. <i>Scott</i>	Podesti-class
NCC-2422	U.S.S. <i>Brokish</i>	Podesti-class
NCC-2423	U.S.S. <i>Trask</i>	Podesti-class
NCC-2424	U.S.S. <i>McKay</i>	Podesti-class
NCC-2425	U.S.S. <i>Kricher</i>	Podesti-class
NCC-2426	U.S.S. <i>Deshler</i>	Podesti-class
NCC-2427	U.S.S. <i>Trav</i>	Podesti-class
NCC-2428	U.S.S. <i>Humphries</i>	Podesti-class
NCC-2429	U.S.S. <i>Griggs</i>	Podesti-class
NCC-2430	U.S.S. <i>Tonge</i>	Podesti-class
NCC-2431	U.S.S. <i>Almaden</i>	Podesti-class
NCC-2432	U.S.S. <i>Brunsen</i>	Podesti-class
NCC-2433	U.S.S. <i>Lee</i>	Podesti-class
NCC-2434	U.S.S. <i>Griffith</i>	Podesti-class
NCC-2435	U.S.S. <i>Jiohann</i>	Podesti-class
NCC-2436	U.S.S. <i>Showpan</i>	Podesti-class
NCC-2437	U.S.S. <i>Iglesia</i>	Podesti-class
NCC-2438	U.S.S. <i>Reavis</i>	Podesti-class
NCC-2442	U.S.S. <i>Nebulary</i>	Constellation-class
NCC-2465	U.S.S. <i>Mayal</i>	
NCC-2500	U.S.S. <i>Decatur</i>	Decatur-class
	Prototype vessel, a strike cruiser, commissioned in 2270.	
	U.S.S. <i>Swift</i>	
NCC-2501	U.S.S. <i>Belknap</i>	Belknap-class
	Heavily modified strike cruiser originally to have been completed as a Decatur-class vessel. However, so many modifications were made to the basic design that it was launched under it's own class name. Launched in 2273.	
	U.S.S. <i>Nova</i>	Constellation-class
NCC-2502	U.S.S. <i>Bradley</i>	Belknap-class
	U.S.S. <i>Nebula</i>	Constellation-class
NCC-2503	U.S.S. <i>Khiritat</i>	
	U.S.S. <i>Polaris</i>	Constellation-class
NCC-2504	U.S.S. <i>Haversham</i>	Belknap-class
	U.S.S. <i>Magellan</i>	Constellation-class
NCC-2505	U.S.S. <i>Sovereign</i>	Belknap-class
	U.S.S. <i>Andromeda</i>	Constellation-class
NCC-2506	U.S.S. <i>Concord</i>	Belknap-class
	U.S.S. <i>Libra</i>	Constellation-class
NCC-2507	U.S.S. <i>Rishiri</i>	Belknap-class
	U.S.S. <i>Sagittarius</i>	Constellation-class
NCC-2508	U.S.S. <i>Essahir</i>	
	U.S.S. <i>Pulsar</i>	Constellation-class
NCC-2509	U.S.S. <i>Jarrett</i>	
	U.S.S. <i>Callisto</i>	Constellation-class

NCC-2510	U.S.S. <i>Fahrion</i>	
	U.S.S. <i>Orion</i>	Constellation-class
NCC-2511	U.S.S. <i>Estocin</i>	
	U.S.S. <i>Eridani</i>	Constellation-class
NCC-2512	U.S.S. <i>Matsurra</i>	Belknap-class
	U.S.S. <i>Taurus</i>	Constellation-class
NCC-2513	U.S.S. <i>Baikal</i>	Belknap-class
	U.S.S. <i>Ceres</i>	Constellation-class
NCC-2514	U.S.S. <i>Haven</i>	Belknap-class
	U.S.S. <i>Antares</i>	Constellation-class
NCC-2515	U.S.S. <i>Pisces</i>	Constellation-class
NCC-2516	U.S.S. <i>Mikuma</i>	Belknap-class
	U.S.S. <i>Lenoid</i>	Constellation-class
NCC-2517	U.S.S. <i>Shangri-La</i>	Belknap-class
	U.S.S. <i>Aquarius</i>	Constellation-class
NCC-2518	U.S.S. <i>Hai Din</i>	Belknap-class
	U.S.S. <i>Indiri</i>	Constellation-class
NCC-2519	U.S.S. <i>Raan</i>	Belknap-class
	U.S.S. <i>Effros</i>	Constellation-class
NCC-2520	U.S.S. <i>Ascension</i>	Ascension-class
	Prototype dreadnought version of the Belknap-class.	
	U.S.S. <i>Betelgeuse</i>	Constellation-class
NCC-2521	U.S.S. <i>Leander</i>	Ascension-class
	U.S.S. <i>Diadem</i>	Constellation-class
NCC-2522	U.S.S. <i>Nashua</i>	Ascension-class
NCC-2523	U.S.S. <i>Sussex</i>	Ascension-class
	U.S.S. <i>Canopus</i>	Constellation-class
NCC-2524	U.S.S. <i>Tai Shan</i>	Ascension-class
	U.S.S. <i>Sirius Major</i>	Constellation-class
NCC-2525	U.S.S. <i>Minsk</i>	Ascension-class
	U.S.S. <i>Minora</i>	Constellation-class
NCC-2526	U.S.S. <i>Hiryu</i>	Ascension-class
NCC-2527	U.S.S. <i>Capodanno</i>	Ascension-class
NCC-2528	U.S.S. <i>Temperance</i>	Ascension-class
NCC-2529	U.S.S. <i>Repulse</i>	Ascension-class
NCC-2530	U.S.S. <i>Impervious</i>	Impervious-class
	First starship of her class, a strike cruiser.	
NCC-2537	U.S.S. <i>Delphin</i>	Impervious-class
NCC-2538	U.S.S. <i>Seneca</i>	Impervious-class
NCC-2539	U.S.S. <i>Ki Rin</i>	Impervious-class
NCC-2540	U.S.S. <i>Cicala</i>	Impervious-class
NCC-2541	U.S.S. <i>Hood</i>	Excelsior-class
	U.S.S. <i>Sur Cha</i>	Impervious-class
NCC-2542	U.S.S. <i>Mira</i>	Impervious-class
NCC-2543	U.S.S. <i>Aveley</i>	Impervious-class

- NCC-2544 U.S.S. *Repulse* Excelsior-class
Starship commanded by Captain Taggart, it was the former posting of Dr. Katherine Pulaski before she was transferred to the U.S.S. *Enterprise* NCC-1701-D in 2365.
- NCC-2545 U.S.S. *Alor*
- NCC-2545 U.S.S. *Excel* Excel-class
First vessel of her class, classified by Starfleet as a strike cruiser.
- NCC-2548 U.S.S. *Vanguard* Excel-class
- NCC-2560 U.S.S. *Athabaska* Athabaska-class
First vessel of her class, an exploratory/strike cruiser.
- NCC-2567 U.S.S. *Dahlgren* Dahlgren-class
Prototype of her class, designated a cruiser. Designed for patrol duties, the ship was crewed by 468 persons and had a deadweight tonnage of 183,000 metric tones. The ship was armed with 8 phaser banks and two torpedo launchers. It was 290m long, 141.7m wide and 65.9m high.
- NCC-2573 U.S.S. *Belisarius* Alexander-class
- NCC-2573 U.S.S. *Roosevelt* Excelsior-class
One of the Federation starships lost to the Borg at the Battle of Wolf 359.
- NCC-2589 U.S.S. *Conquest* Conquest-class
First vessel of her class, a dreadnought with a tonnage of 239,000 metric tonnes. The ship had a crew compliment of 530, and was armed with seven dual phaser banks and two torpedo launchers. The *Conquest* was 300.8m long, 141.7m wide and 74.1m tall.
- NCC-2590 U.S.S. *Valkyrie* Constellation-class
Starship that was lost and presumed destroyed.
- NCC-2593 U.S.S. *Hathaway* Constellation-class
Starship commissioned in 2285, it was built at the Copernicus Shipyards on Luna. The *Hathaway* was decommissioned prior to 2365 when it was part of a Starfleet war-games exercise. The ship's motto was "No matter where you go, there you are..."
- NCC-2600 U.S.S. *Komsomolsk* Komsomolsk-class
First vessel of her class, designated as a dreadnought.
- NCC-2605 U.S.S. *Concord*
- NCC-2607 U.S.S. *Pharriss* Komsomolsk-class
- NCC-2610 U.S.S. *Chosin* Chosin-class
Starship classified by the Fleet as an attack-carrier.
- NCC-2635 U.S.S. *Davenport* Davenport-class
First vessel of her class, designated a corvette by Starfleet's standards.
- NCC-2679 U.S.S. *Christopher* Christopher-class
Vessel classified as a corvette, the first in her class.
- NCC-2700 U.S.S. *Loknar* Loknar-class
First starship of her class, a medium frigate.

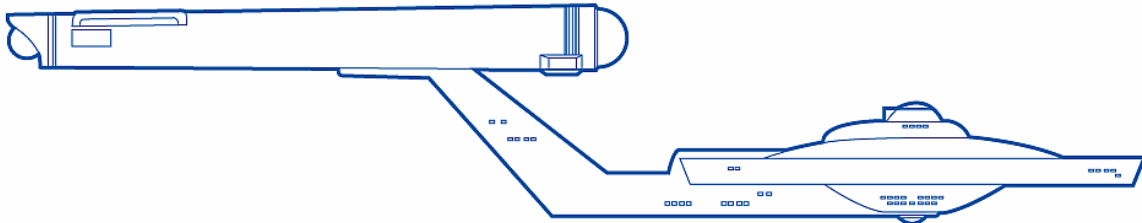

U.S.S. *Joshua* Joshua-class
First starship of her class, a command cruiser.

NCC-2701	U.S.S. <i>Ahkeil</i>	Loknar-class
	U.S.S. <i>Ranger</i>	Ranger-class
	First starship of her class, designated a light cruiser.	
	U.S.S. <i>Hamilton</i>	Joshua-class
NCC-2702	U.S.S. <i>Vernol</i>	Loknar-class
	U.S.S. <i>April</i>	Joshua-class
NCC-2703	U.S.S. <i>Trantis</i>	Loknar-class
	U.S.S. <i>Irvington</i>	Joshua-class
NCC-2704	U.S.S. <i>Morgan City</i>	Loknar-class
	U.S.S. <i>Cheney</i>	Joshua-class
NCC-2705	U.S.S. <i>Farside</i>	Loknar-class
	U.S.S. <i>Rypli</i>	Joshua-class
NCC-2706	U.S.S. <i>New America</i>	Loknar-class
	U.S.S. <i>T'Leinad</i>	Joshua-class
NCC-2707	U.S.S. <i>Fife</i>	Joshua-class
NCC-2708	U.S.S. <i>Kosk</i>	Loknar-class
	U.S.S. <i>O'Neill</i>	Joshua-class
NCC-2709	U.S.S. <i>Borga</i>	Loknar-class
	U.S.S. <i>Macarthur</i>	Joshua-class
NCC-2710	U.S.S. <i>Peking</i>	Loknar-class
	U.S.S. <i>Geronimo</i>	Joshua-class
NCC-2711	U.S.S. <i>Epcot</i>	Loknar-class
	U.S.S. <i>Habstran</i>	Joshua-class
NCC-2712	U.S.S. <i>Aldebaran</i>	Loknar-class
	U.S.S. <i>Levitt</i>	Joshua-class
NCC-2713	U.S.S. <i>Proxima</i>	Loknar-class
NCC-2714	U.S.S. <i>Antares</i>	Loknar-class
NCC-2715	U.S.S. <i>Argus City</i>	Loknar-class
NCC-2716	U.S.S. <i>New York</i>	Loknar-class
NCC-2717	U.S.S. <i>Boridi</i>	Loknar-class
NCC-2718	U.S.S. <i>Moscow</i>	Loknar-class
NCC-2719	U.S.S. <i>Tokyo</i>	Loknar-class
NCC-2720	U.S.S. <i>Corinth IV</i>	Loknar-class
NCC-2721	U.S.S. <i>Daran V</i>	Loknar-class
NCC-2722	U.S.S. <i>Paris</i>	Loknar-class
NCC-2723	U.S.S. <i>Elas</i>	Loknar-class
NCC-2724	U.S.S. <i>Troyius</i>	Loknar-class
NCC-2726	U.S.S. <i>Rome</i>	Loknar-class
NCC-2727	U.S.S. <i>Los Angeles</i>	Loknar-class
NCC-2728	U.S.S. <i>Ekos</i>	Loknar-class
NCC-2729	U.S.S. <i>Yonada</i>	Loknar-class
NCC-2730	U.S.S. <i>Makusia</i>	Loknar-class
NCC-2731	U.S.S. <i>Berlin</i>	Loknar-class
NCC-2732	U.S.S. <i>Opkapi</i>	Loknar-class
NCC-2733	U.S.S. <i>Aurelia</i>	Loknar-class
NCC-2734	U.S.S. <i>Ciarinae II</i>	Loknar-class
NCC-2735	U.S.S. <i>Antos IV</i>	Loknar-class

NCC-2736	U.S.S. <i>Arcannis</i>	Loknar-class
NCC-2737	U.S.S. <i>Mordensia</i>	Loknar-class
NCC-2738	U.S.S. <i>Chicago</i>	Loknar-class
NCC-2739	U.S.S. <i>Deneb Clar</i>	Loknar-class
NCC-2740	U.S.S. <i>Gaikos</i>	Loknar-class
NCC-2741	U.S.S. <i>Sydney</i>	Loknar-class
NCC-2742	U.S.S. <i>Halk</i>	Loknar-class
NCC-2743	U.S.S. <i>Ilyra</i>	Loknar-class
NCC-2744	U.S.S. <i>Mjorn</i>	Loknar-class
NCC-2745	U.S.S. <i>Alondra</i>	Loknar-class
NCC-2746	U.S.S. <i>Carinae V</i>	Loknar-class
NCC-2747	U.S.S. <i>Argelia</i>	Loknar-class
NCC-2748	U.S.S. <i>Lactra</i>	Loknar-class
NCC-2749	U.S.S. <i>London</i>	Loknar-class
NCC-2750	U.S.S. <i>Deneva Ra</i>	Loknar-class
NCC-2751	U.S.S. <i>Izar</i>	Loknar-class
NCC-2752	U.S.S. <i>Titan</i>	Loknar-class
NCC-2753	U.S.S. <i>Rhea</i>	Loknar-class
NCC-2754	U.S.S. <i>Helios</i>	Loknar-class
NCC-2755	U.S.S. <i>Capor Bana</i>	Loknar-class
NCC-2756	U.S.S. <i>Houston</i>	Loknar-class
NCC-2757	U.S.S. <i>Rio De Janiero</i>	Loknar-class
NCC-2758	U.S.S. <i>Lavinius</i>	Loknar-class
NCC-2759	U.S.S. <i>Dallas</i>	Loknar-class
NCC-2760	U.S.S. <i>Irilia</i>	Loknar-class
NCC-2761	U.S.S. <i>Karrik Al Van</i>	Loknar-class
	U.S.S. <i>Thruxton</i>	Thruxton-class
	First starship of her class, designated a tactical cruiser.	
NCC-2762	U.S.S. <i>Thefel</i>	Loknar-class
NCC-2763	U.S.S. <i>Ptarth</i>	Loknar-class
NCC-2764	U.S.S. <i>Alpha Colony</i>	Loknar-class
NCC-2765	U.S.S. <i>Altair VI</i>	Loknar-class
NCC-2766	U.S.S. <i>Ariannus</i>	Loknar-class
NCC-2767	U.S.S. <i>Cairo</i>	Loknar-class
NCC-2768	U.S.S. <i>Coridan</i>	Loknar-class
NCC-2769	U.S.S. <i>Cygnia Minor</i>	Loknar-class
NCC-2770	U.S.S. <i>Drox</i>	Loknar-class
NCC-2771	U.S.S. <i>Toronto</i>	Loknar-class
NCC-2772	U.S.S. <i>Trifis</i>	Loknar-class
NCC-2773	U.S.S. <i>Bondorant</i>	Loknar-class
NCC-2774	U.S.S. <i>Garros</i>	Loknar-class
NCC-2775	U.S.S. <i>Janus Colony</i>	Loknar-class
NCC-2776	U.S.S. <i>Iotia</i>	Loknar-class
NCC-2777	U.S.S. <i>Tryla</i>	Loknar-class
NCC-2778	U.S.S. <i>Vladivostok</i>	Loknar-class
NCC-2779	U.S.S. <i>Noma Ra Den</i>	Loknar-class
NCC-2780	U.S.S. <i>New Delphi</i>	Loknar-class

NCC-2781	U.S.S. <i>Salos</i>	Loknar-class
NCC-2782	U.S.S. <i>Thuphylla</i>	Loknar-class
NCC-2783	U.S.S. <i>Moldens</i>	Loknar-class
NCC-2784	U.S.S. <i>Mantilles</i>	Loknar-class
NCC-2785	U.S.S. <i>Sogon</i>	Loknar-class
NCC-2786	U.S.S. <i>Phobos</i>	Loknar-class
NCC-2787	U.S.S. <i>Luna</i>	Loknar-class
NCC-2788	U.S.S. <i>Johannesburg</i>	Loknar-class
NCC-2789	U.S.S. <i>Stockholm</i>	Loknar-class
NCC-2790	U.S.S. <i>Manon</i>	Manon-class
	First vessel of her class, designated a destroyer.	
	U.S.S. <i>Fall Den</i>	Loknar-class
NCC-2791	U.S.S. <i>Que Dane</i>	Loknar-class
NCC-2793	U.S.S. <i>Jezar</i>	Loknar-class
NCC-2794	U.S.S. <i>Hobbiton</i>	Loknar-class
NCC-2795	U.S.S. <i>Hong Kong</i>	Loknar-class
NCC-2796	U.S.S. <i>Caitos Prea</i>	Loknar-class
NCC-2797	U.S.S. <i>Mulandra</i>	Loknar-class
NCC-2798	U.S.S. <i>Kism</i>	Loknar-class
NCC-2799	U.S.S. <i>Tog</i>	Loknar-class
NCC-2830	U.S.S. <i>Valor</i>	Valor-class
	First vessel of her class, a strike cruiser. Designed to operate as an infantry transport, it carries Marine assault fighters in its upper port hangar, interception craft in it's upper starboard hanger ad regular shuttlecraft in it's main hangar at the end of the secondary hull. Crewed by 490 persons, it weighed 193,000 metric tones. Armed with two megaphaser emplacements, seven dual phaser banks and two pho-torp tubes, the ship was 290m long, 141.7m wide and 67.9m high.	
NCC-2857	U.S.S. <i>Sirus</i>	Constellation-class
NCC-2864	U.S.S. <i>Terrell</i>	
NCC-2887	U.S.S. <i>Fearless</i>	
NCC-2893	U.S.S. <i>Stargazer</i>	Constellation-class
	Starship commanded by Jean-Luc Picard from 2333 to 2355, when it was thought destroyed at the Maxia Zeta system. The derelict <i>Stargazer</i> was returned to Starfleet by Ferengi Daimon Bok. The ship's motto was " <i>To bring light into the darkness.</i> "	
NCC-2893-A	U.S.S. <i>Stargazer</i>	Intrepid-class
	The <i>Stargazer</i> was commanded by Captain Rackham in 2373.	
NCC-2894	U.S.S. <i>Starquest</i>	Constellation-class
NCC-2901	U.S.S. <i>Scimitar</i>	Scimitar-class
	First starship of her class, designated a fast destroyer.	
NCC-2923	U.S.S. <i>Kirov</i>	Kirov-class
	Starship, the first of her class. A dreadnought based on the Excelsior-class platform.	
NCC-2951	U.S.S. <i>Phantom</i>	Phantom-class
	First starship of her class, designated a superscout.	

NCC-3000	U.S.S. <i>Kestral</i>	Kestral-class
	First vessel of her class, designated a superscout. The ship had two nacelles, and a OC9777W Passive “Big Ear” Sensor Nacelle that detects distant enemy ships and communications. The ship carried a large contingent of cryptographic techs among it’s 290 crew, and weighed 135,000 metric tones. The ship was armed with 6 dual phaser banks and was 276.8m long, 141.7m wide and 61.4m high.	
	U.S.S. <i>Royal Sovereign</i>	Royal Sovereign-class
	First vessel of her class, the <i>Royal Sovereign</i> was classified a battle cruiser.	
NCC-3001	U.S.S. <i>Alaska</i>	Royal Sovereign-class
NCC-3002	U.S.S. <i>Royal Andor</i>	Royal Sovereign-class
NCC-3003	U.S.S. <i>Kola</i>	Royal Sovereign-class
NCC-3004	U.S.S. <i>Royal Proxima</i>	Royal Sovereign-class
NCC-3005	U.S.S. <i>Nagato</i>	Royal Sovereign-class
NCC-3006	U.S.S. <i>Discovery</i>	Royal Sovereign-class
NCC-3007	U.S.S. <i>Saratoga</i>	Royal Sovereign-class
NCC-3008	U.S.S. <i>Royal Centauri</i>	Royal Sovereign-class
NCC-3009	U.S.S. <i>Royal Hibernia</i>	Royal Sovereign-class
NCC-3010	U.S.S. <i>Valiant</i>	Royal Sovereign-class
NCC-3011	U.S.S. <i>Jean Bart</i>	Royal Sovereign-class
NCC-3029	U.S.S. <i>Adamant</i>	Adamant-class
	Prototype of her class, a dreadnought.	
NCC-3039	U.S.S. <i>Barcelona</i>	Roosevelt-class
NCC-3040	U.S.S. <i>Nimitz</i>	Roosevelt-class
NCC-3041	U.S.S. <i>Java</i>	Roosevelt-class
NCC-3069	U.S.S. <i>Magellan</i>	Constellation-class
	Starship commanded by Captain Conkin, it was part of the fleet that retook <i>Deep Space Nine</i> from Dominion forces in 2373.	
NCC-3088	U.S.S. <i>Nimitz</i>	
NCC-3092	U.S.S. <i>Lexington</i>	Lexington-class
	First vessel of her class.	
NCC-3100	U.S.S. <i>Menahga</i>	Menahga-class
	First starship of her class, a heavy destroyer.	
NCC-3101	U.S.S. <i>Arsuf</i>	Menahga-class
NCC-3102	U.S.S. <i>Koryak</i>	
NCC-3103	U.S.S. <i>Mitannic</i>	Mitannic-class
	First starship of her class, designated a battle cruiser.	
NCC-3104	U.S.S. <i>Hastings</i>	Mitannic-class
NCC-3105	U.S.S. <i>Marathon</i>	Mitannic-class
NCC-3106	U.S.S. <i>Pashto</i>	Mitannic-class
NCC-3107	U.S.S. <i>Avendesta</i>	
	U.S.S. <i>S'Harien</i>	S’Harien-class
	First vessel of her class, a battle cruiser.	
NCC-3108	U.S.S. <i>Austerlitz</i>	Mitannic-class
NCC-3109	U.S.S. <i>Zetar</i>	Mitannic-class
NCC-3112	U.S.S. <i>Andernach</i>	Andernach-class
	Prototype of her class, a battle cruiser.	
NCC-3114	U.S.S. <i>Casthes</i>	Durkan-class
	Light cruiser. Destroyed in Sector 1517, fourteen years after being commissioned.	
NCC-3135	U.S.S. <i>Coeur De Lion</i>	

NCC-3190	U.S.S. <i>Apache</i> First starship of her class, a cruiser.	Apache-class
NCC-3201	U.S.S. <i>Daran</i> Prototype of her class, the ship was designated a fast frigate.	Daran-class
NCC-3202	U.S.S. <i>Haruna</i>	Daran-class
NCC-3203	U.S.S. <i>Eten</i>	Daran-class
NCC-3204	U.S.S. <i>Vinson</i>	Daran-class
NCC-3205	U.S.S. <i>Ser'rath</i>	Daran-class
NCC-3206	U.S.S. <i>Dace</i>	Daran-class
NCC-3207	U.S.S. <i>Kidd</i>	Daran-class
NCC-3208	U.S.S. <i>Stark</i>	Daran-class
NCC-3209	U.S.S. <i>Di Jahan</i>	Daran-class
NCC-3210	U.S.S. <i>Brooke</i>	Daran-class
NCC-3211	U.S.S. <i>Soryu</i>	Daran-class
NCC-3212	U.S.S. <i>Atalanti</i>	Daran-class
NCC-3213	U.S.S. <i>Darter</i> Fast frigate, first of her class.	Darter-class
NCC-3214	U.S.S. <i>Ianar</i> First starship of her class, a fast frigate.	Ianar-class

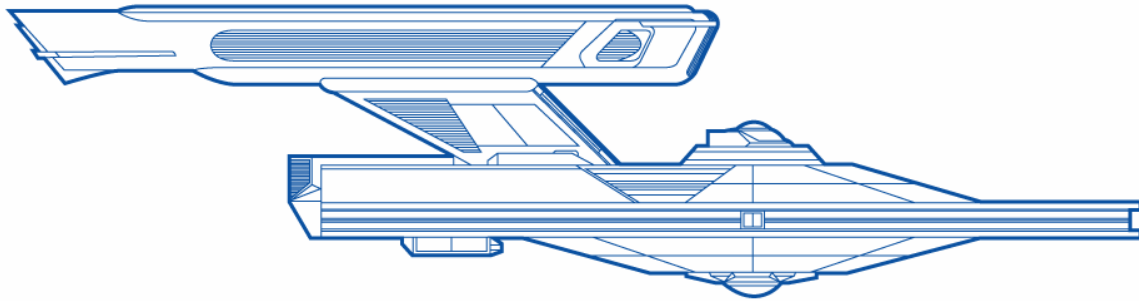

NCC-3215	U.S.S. <i>Nasan</i>	Ianar-class
NCC-3216	U.S.S. <i>Rnonkak</i>	Ianar-class
NCC-3217	U.S.S. <i>Mari'a'neku</i>	Ianar-class
NCC-3218	U.S.S. <i>Shi Yan</i>	Ianar-class
NCC-3219	U.S.S. <i>Anshan</i>	Ianar-class
NCC-3220	U.S.S. <i>Di Vann</i>	Ianar-class
NCC-3221	U.S.S. <i>Kanpalu</i>	Ianar-class
NCC-3222	U.S.S. <i>Raan Suk</i>	Ianar-class
NCC-3223	U.S.S. <i>Mik Faran</i>	Ianar-class
NCC-3224	U.S.S. <i>Beihai</i>	Ianar-class
NCC-3225	U.S.S. <i>Ehurach</i>	Ianar-class
NCC-3226	U.S.S. <i>Tu Zhong</i>	Ianar-class
NCC-3227	U.S.S. <i>Du Chong</i>	Ianar-class
NCC-3228	U.S.S. <i>Chengdu</i>	Ianar-class
NCC-3229	U.S.S. <i>Lobruuk</i>	Ianar-class
NCC-3230	U.S.S. <i>Tanzu</i>	Ianar-class
NCC-3231	U.S.S. <i>Omuvi</i>	Ianar-class
	U.S.S. <i>Decisive</i> First vessel of her class, a fast frigate.	Decisive-class
NCC-3232	U.S.S. <i>Fujian</i>	Ianar-class

NCC-3233	U.S.S. <i>Jari'a'neku</i>	Ianar-class
NCC-3234	U.S.S. <i>Galati</i>	Ianar-class
NCC-3235	U.S.S. <i>Fuzhun</i>	Ianar-class
NCC-3236	U.S.S. <i>Betzic</i>	Ianar-class
NCC-3237	U.S.S. <i>Couran</i>	Ianar-class
NCC-3238	U.S.S. <i>Pi Quaran</i>	Ianar-class
NCC-3239	U.S.S. <i>Haffac</i>	Ianar-class
NCC-3240	U.S.S. <i>Ijis</i>	Ianar-class
NCC-3241	U.S.S. <i>Satun Fatu</i>	Ianar-class
NCC-3242	U.S.S. <i>Ebanol</i>	Ianar-class
NCC-3243	U.S.S. <i>Do'Lomi</i>	Ianar-class
NCC-3244	U.S.S. <i>Ding Hai</i>	Ianar-class
NCC-3245	U.S.S. <i>Molo Taz</i>	Ianar-class
NCC-3246	U.S.S. <i>Tani Gratan</i>	Ianar-class
NCC-3247	U.S.S. <i>Basan Goru</i>	Ianar-class
NCC-3248	U.S.S. <i>Dagu</i>	Ianar-class
NCC-3249	U.S.S. <i>Guiyang</i>	Ianar-class
	U.S.S. <i>Babcock</i>	Babcock-class
	Starship, the first vessel of her class.	
NCC-3250	U.S.S. <i>Renner</i>	Renner-class
	Corvette, first of her class.	

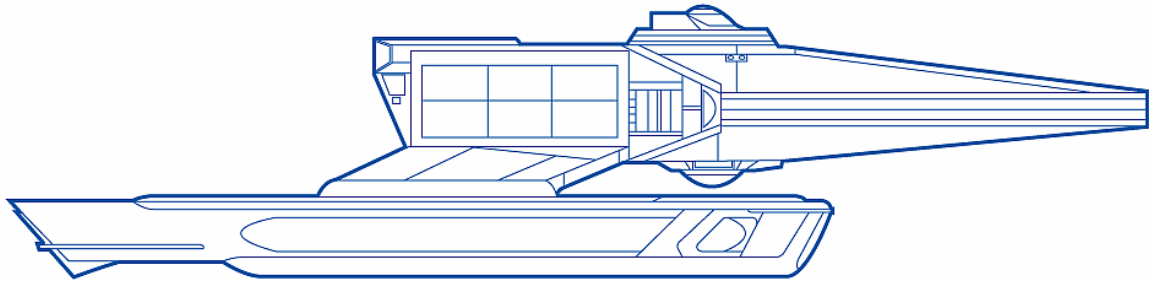

NCC-3251	U.S.S. <i>Robust</i>	Renner-class
NCC-3252	U.S.S. <i>Mantis</i>	Renner-class
NCC-3253	U.S.S. <i>Victory</i>	
NCC-3254	U.S.S. <i>Dauntless</i>	Renner-class
NCC-3255	U.S.S. <i>Bristol</i>	Bristol-class
	First starship of her class.	
	U.S.S. <i>Arcadia</i>	
NCC-3256	U.S.S. <i>Serene</i>	Renner-class
NCC-3257	U.S.S. <i>Invincible</i>	Renner-class
NCC-3258	U.S.S. <i>Axbrell</i>	
NCC-3259	U.S.S. <i>Ixaarn</i>	Renner-class
NCC-3260	U.S.S. <i>Mako</i>	Renner-class
NCC-3261	U.S.S. <i>Shah Jahan</i>	Renner-class
NCC-3262	U.S.S. <i>Buxxshat</i>	Renner-class
NCC-3263	U.S.S. <i>Escovedo</i>	Renner-class
NCC-3264	U.S.S. <i>Valorous</i>	Renner-class
NCC-3265	U.S.S. <i>Julguasth</i>	Renner-class

NCC-3266	U.S.S. <i>Tashanka</i>	Renner-class
NCC-3267	U.S.S. <i>Erand</i>	Renner-class
NCC-3268	U.S.S. <i>Katana</i>	Renner-class
NCC-3269	U.S.S. <i>Durant</i>	Renner-class
NCC-3270	U.S.S. <i>Regal</i>	Renner-class
NCC-3300	U.S.S. <i>Juliet</i>	Juliet-class
	Prototype vessel of her class, a corvette.	
NCC-3302	U.S.S. <i>Paoki</i>	Juliet-class
	U.S.S. <i>Crimea</i>	Hellespont-class
	Starship destroyed with the loss of Captain Thara Reska and most of her bridge crew while protecting a Federation convoy from a pirate attack in 2271.	
NCC-3317	U.S.S. <i>Lautaro</i>	Lautaro-class
	First starship of her class, classified a corvette by Starfleet.	
NCC-3318	U.S.S. <i>Varanasi</i>	Lautaro-class
NCC-3321	U.S.S. <i>Constant</i>	Constant-class
	Prototype of her class, a battle cruiser. Weighing 173,000 metric tones, the ship had a crew of 305. Armed with eight phaser banks and two torpedo launchers, it's large secondary hull had two complete hangars. The ship was 307.5m long, 141.7m wide and 78m high.	
NCC-3325	U.S.S. <i>Bretha</i>	Hellespont-class
NCC-3340	U.S.S. <i>Riga</i>	Riga-class
	Prototype of her class, a corvette.	
NCC-3361	U.S.S. <i>Malinche</i>	Excelsior-class
NCC-3367	U.S.S. <i>Teclopi</i>	Elladan-class
	Starship that served Starfleet for eighteen years.	
NCC-3372	U.S.S. <i>Eta Carinae</i>	Carina-class
NCC-3386	U.S.S. <i>Falcon</i>	
NCC-3400	U.S.S. <i>Catchon</i>	Catchon-class
	Interceptor, first of her class.	
NCC-3401	U.S.S. <i>Wommack</i>	Catchon-class
NCC-3402	U.S.S. <i>Ortman</i>	
NCC-3403	U.S.S. <i>Cleavenger</i>	Catchon-class
NCC-3404	U.S.S. <i>Dunham</i>	Catchon-class
NCC-3405	U.S.S. <i>Bendiver</i>	Catchon-class
NCC-3406	U.S.S. <i>Gavin</i>	Catchon-class
NCC-3407	U.S.S. <i>Hobbes</i>	
NCC-3408	U.S.S. <i>Crownover</i>	Catchon-class
NCC-3409	U.S.S. <i>Maxstream</i>	Catchon-class
NCC-3410	U.S.S. <i>Adamant</i>	Catchon-class
NCC-3411	U.S.S. <i>Dardin</i>	Catchon-class
NCC-3412	U.S.S. <i>Hoft</i>	Catchon-class
NCC-3413	U.S.S. <i>Rothenberg</i>	Catchon-class
NCC-3414	U.S.S. <i>Laten</i>	Catchon-class
NCC-3415	U.S.S. <i>Maynard</i>	Catchon-class
NCC-3416	U.S.S. <i>Swang</i>	Catchon-class
NCC-3417	U.S.S. <i>Devlin</i>	Catchon-class
NCC-3418	U.S.S. <i>Eeler</i>	Catchon-class
NCC-3419	U.S.S. <i>Glover</i>	Catchon-class

NCC-3420	U.S.S. <i>Temmen</i>	
NCC-3421	U.S.S. <i>Harrison</i>	Catchon-class
NCC-3422	U.S.S. <i>Russnak</i>	Catchon-class
NCC-3423	U.S.S. <i>Piedmont</i>	Catchon-class
NCC-3424	U.S.S. <i>Lund</i>	Catchon-class
NCC-3425	U.S.S. <i>Jarvis</i>	Catchon-class
NCC-3457	U.S.S. <i>Matterhorn</i>	Hellespont-class
NCC-3476	U.S.S. <i>Java</i>	
NCC-3537	U.S.S. <i>Pharris</i>	Pharris-class
	First vessel of her class, designated a strategic frigate.	
NCC-3600	U.S.S. <i>Commanche</i>	Commanche-class
	An assault frigate, the first of her class.	
NCC-3601	U.S.S. <i>Babin</i>	Commanche-class
NCC-3602	U.S.S. <i>Crushert</i>	Commanche-class
NCC-3603	U.S.S. <i>Raines</i>	Commanche-class
NCC-3604	U.S.S. <i>Yost</i>	Commanche-class
NCC-3605	U.S.S. <i>Burnham</i>	Commanche-class
NCC-3606	U.S.S. <i>Badggett</i>	Commanche-class
NCC-3607	U.S.S. <i>Fedance</i>	Commanche-class
NCC-3608	U.S.S. <i>Pendulem</i>	Commanche-class
NCC-3609	U.S.S. <i>Arappaho</i>	Commanche-class
NCC-3610	U.S.S. <i>Winneger</i>	Commanche-class
NCC-3611	U.S.S. <i>Sykes</i>	Commanche-class
NCC-3612	U.S.S. <i>Navvarro</i>	Commanche-class
NCC-3613	U.S.S. <i>Harndin</i>	Commanche-class
NCC-3614	U.S.S. <i>Carris</i>	Commanche-class
NCC-3615	U.S.S. <i>Shawnee</i>	Commanche-class
NCC-3616	U.S.S. <i>Kiowa</i>	Commanche-class
NCC-3617	U.S.S. <i>Houser</i>	Commanche-class
NCC-3618	U.S.S. <i>Van Zandt</i>	Commanche-class
NCC-3619	U.S.S. <i>Littleer</i>	Commanche-class
NCC-3620	U.S.S. <i>Woulard</i>	Commanche-class
NCC-3621	U.S.S. <i>Terrell</i>	Commanche-class
NCC-3622	U.S.S. <i>Stewart</i>	Commanche-class
NCC-3623	U.S.S. <i>Tannoraro</i>	Commanche-class
NCC-3624	U.S.S. <i>Onuoha</i>	Commanche-class
NCC-3625	U.S.S. <i>Hook</i>	Commanche-class
NCC-3626	U.S.S. <i>Gaither</i>	Commanche-class
NCC-3627	U.S.S. <i>Elkins</i>	Commanche-class
NCC-3628	U.S.S. <i>Abanowicz</i>	Commanche-class
NCC-3629	U.S.S. <i>Darby</i>	Commanche-class
NCC-3767	U.S.S. <i>Benjamin Franklin</i>	Benjamin Franklin-class
	Light cruiser, the first vessel of her class. Launched in 2302, the ship was 296m long, 172m wide and 54m high. The ship had a crew of 325.	
NCC-3800	U.S.S. <i>Moncrief</i>	Moncrief-class
	Starship, first of her class, a cargo tug.	

NCC-3801	U.S.S. <i>Ptolemy</i>	Ptolemy-class Pathfinder vessel of her class, a transport/tug. 222m long, 127.1m wide and 66m high. With a deadweight metric tonnage of 126,500 it had a crew of 220.
NCC-3802	U.S.S. <i>Al Rashid</i>	Ptolemy-class
NCC-3803	U.S.S. <i>Swift-Tuttle</i>	Ptolemy-class
	U.S.S. <i>Anaxagoras</i>	Ptolemy-class
NCC-3804	U.S.S. <i>Jan Oort</i>	Ptolemy-class
	U.S.S. <i>Anaximander</i>	Ptolemy-class
NCC-3805	U.S.S. <i>Stephen Hawking</i>	Ptolemy-class
	U.S.S. <i>Aristarchus</i>	Ptolemy-class
NCC-3806	U.S.S. <i>Ibn Daud</i>	Ptolemy-class
NCC-3807	U.S.S. <i>Eratosthenes</i>	Ptolemy-class
NCC-3808	U.S.S. <i>Galilei</i>	Ptolemy-class
NCC-3809	U.S.S. <i>Hipparchos</i>	Ptolemy-class
NCC-3810	U.S.S. <i>Ulugh Beg</i>	Ptolemy-class
NCC-3811	U.S.S. <i>Philolaus</i>	Ptolemy-class
NCC-3812	U.S.S. <i>Pythagoras</i>	Ptolemy-class
NCC-3813	U.S.S. <i>Thales</i>	Ptolemy-class
NCC-3814	U.S.S. <i>Hevelius</i>	Ptolemy-class
NCC-3815	U.S.S. <i>Copernicus</i>	Ptolemy-class
NCC-3816	U.S.S. <i>Kepler</i>	Kepler-class First starship of her class, a technological advancement of the Ptolemy-class.
NCC-3817	U.S.S. <i>Ambartsumian</i>	Kepler-class
NCC-3818	U.S.S. <i>Flamarion</i>	Kepler-class
NCC-3819	U.S.S. <i>Schiaparelli</i>	Kepler-class
NCC-3820	U.S.S. <i>Deslandres</i>	Kepler-class
NCC-3821	U.S.S. <i>Brahe</i>	Kepler-class
	U.S.S. <i>Orestes</i>	Ramses-class Heavy cruiser, assigned to Starbase 324.
NCC-3822	U.S.S. <i>Newton</i>	Kepler-class
NCC-3823	U.S.S. <i>Riccioli</i>	Kepler-class
NCC-3824	U.S.S. <i>Cassini</i>	Kepler-class
NCC-3825	U.S.S. <i>Donati</i>	Kepler-class
NCC-3826	U.S.S. <i>Kidinnu</i>	Kepler-class
NCC-3827	U.S.S. <i>Piazzi</i>	Kepler-class
NCC-3828	U.S.S. <i>Leverrier</i>	Kepler-class
NCC-3829	U.S.S. <i>Luyten</i>	Kepler-class
NCC-3830	U.S.S. <i>Messier</i>	Kepler-class
NCC-3831	U.S.S. <i>Doppler</i>	Doppler-class First starship of her class, a technological advancement of the Ptolemy-class.
NCC-3832	U.S.S. <i>Gaillot</i>	Doppler-class
NCC-3833	U.S.S. <i>Halley</i>	Doppler-class
NCC-3834	U.S.S. <i>Holden</i>	Doppler-class
NCC-3835	U.S.S. <i>Jeffrey</i>	Doppler-class
NCC-3836	U.S.S. <i>Kuiper</i>	Doppler-class
NCC-3837	U.S.S. <i>Oort</i>	Doppler-class
NCC-3838	U.S.S. <i>Pritchett</i>	Doppler-class

NCC-3839	U.S.S. <i>Savary</i>	Doppler-class
NCC-3840	U.S.S. <i>Struve</i>	Doppler-class
NCC-3841	U.S.S. <i>Vogel</i>	Doppler-class
NCC-3842	U.S.S. <i>Airy</i>	Doppler-class
NCC-3843	U.S.S. <i>Bondi</i>	Doppler-class
NCC-3844	U.S.S. <i>Chauvenet</i>	Doppler-class
NCC-3845	U.S.S. <i>Eddington</i>	Doppler-class

Starship that received a distress call from a scout vessel during the “interstellar gate” incident; it found all ten of the scout’s crew dead.

NCC-3846	U.S.S. <i>Gautier</i>	Doppler-class
NCC-3847	U.S.S. <i>Hencke</i>	Doppler-class
NCC-3848	U.S.S. <i>Hubble</i>	Doppler-class
NCC-3849	U.S.S. <i>Leavitt</i>	Doppler-class
NCC-3850	U.S.S. <i>Peale</i>	Doppler-class
NCC-3851	U.S.S. <i>Rittenhouse</i>	Doppler-class
NCC-3852	U.S.S. <i>Secchi</i>	Doppler-class
NCC-3853	U.S.S. <i>Tombaugh</i>	Doppler-class
NCC-3854	U.S.S. <i>Wolaston</i>	Doppler-class
NCC-3855	U.S.S. <i>Baade</i>	Doppler-class
NCC-3856	U.S.S. <i>Campell</i>	Doppler-class
NCC-3857	U.S.S. <i>Columbo</i>	Doppler-class
NCC-3858	U.S.S. <i>Encke</i>	Doppler-class
NCC-3859	U.S.S. <i>Goldricke</i>	Doppler-class
NCC-3860	U.S.S. <i>Herschell</i>	Doppler-class
NCC-3861	U.S.S. <i>Humanson</i>	Doppler-class
NCC-3862	U.S.S. <i>Klepstra</i>	Doppler-class
NCC-3863	U.S.S. <i>Mitchell</i>	Doppler-class
NCC-3864	U.S.S. <i>Pickering</i>	Doppler-class
NCC-3865	U.S.S. <i>Ross</i>	Doppler-class
NCC-3866	U.S.S. <i>Shklovsky</i>	Doppler-class
NCC-3867	U.S.S. <i>Toscanelli</i>	Doppler-class
NCC-3868	U.S.S. <i>Wright</i>	Doppler-class
NCC-3869	U.S.S. <i>Bayer</i>	Doppler-class
NCC-3870	U.S.S. <i>Carrington</i>	Doppler-class
NCC-3871	U.S.S. <i>Kruger</i>	Doppler-class
NCC-3872	U.S.S. <i>Fracastor</i>	Doppler-class
NCC-3873	U.S.S. <i>Hale</i>	Doppler-class
NCC-3874	U.S.S. <i>Hirayama</i>	Doppler-class
NCC-3875	U.S.S. <i>Jansky</i>	Doppler-class
NCC-3876	U.S.S. <i>Laplace</i>	Doppler-class
NCC-3877	U.S.S. <i>Newcomb</i>	Doppler-class
NCC-3878	U.S.S. <i>Popper</i>	Doppler-class
NCC-3879	U.S.S. <i>Sabine</i>	Doppler-class
NCC-3880	U.S.S. <i>Schmidt</i>	Doppler-class
NCC-3881	U.S.S. <i>Van De Kamp</i>	Doppler-class
NCC-3882	U.S.S. <i>Von Zach</i>	Doppler-class
NCC-3883	U.S.S. <i>Chamberlain</i>	Doppler-class

NCC-3884	U.S.S. <i>Biela</i>	Doppler-class
NCC-3885	U.S.S. <i>Dollfus</i>	Doppler-class
NCC-3886	U.S.S. <i>Galle</i>	Doppler-class
NCC-3887	U.S.S. <i>Hayashi</i>	Doppler-class
NCC-3888	U.S.S. <i>Hubbard</i>	Doppler-class
NCC-3889	U.S.S. <i>Kaula</i>	Doppler-class
NCC-3890	U.S.S. <i>Gettysburg</i>	Constellation-class

The last starship commanded by Mark Jameson prior to his promotion to Admiral. The *Gettysburg* docked at Deep Space Nice in 2375.

	U.S.S. <i>Lockyer</i>	Doppler-class
NCC-3891	U.S.S. <i>Palitzsch</i>	Doppler-class
NCC-3892	U.S.S. <i>Reber</i>	Doppler-class
NCC-3893	U.S.S. <i>Scheiner</i>	Doppler-class
NCC-3894	U.S.S. <i>Swift</i>	Doppler-class
NCC-3895	U.S.S. <i>Walker</i>	Doppler-class
NCC-3896	U.S.S. <i>Apian</i>	Doppler-class
NCC-3897	U.S.S. <i>Brouwer</i>	Doppler-class
NCC-3898	U.S.S. <i>Clark</i>	Doppler-class
NCC-3899	U.S.S. <i>Dreyer</i>	Doppler-class
NCC-3900	U.S.S. <i>Cheetah</i>	Cheetah-class

First vessel of her class, a fast cruiser.

	U.S.S. <i>Dollond</i>	Dollond-class
--	-----------------------	---------------

First starship of her class, a technological advancement of the Ptolemy-class.

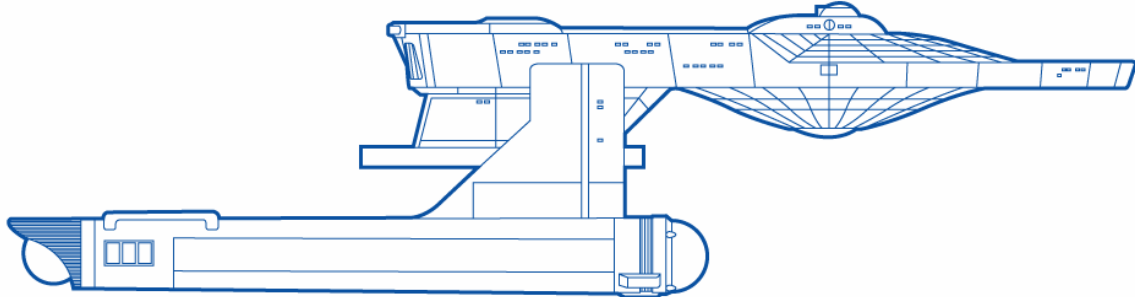

NCC-3901	U.S.S. <i>Guatania</i>	
	U.S.S. <i>Goldreich</i>	Dollond-class
NCC-3902	U.S.S. <i>Cartonian</i>	
	U.S.S. <i>Hertzprung</i>	Dollond-class
NCC-3903	U.S.S. <i>Hammitick</i>	
	U.S.S. <i>Irwin</i>	Dollond-class
NCC-3904	U.S.S. <i>Yeldel</i>	
	U.S.S. <i>Kohlschutter</i>	Dollond-class
NCC-3905	U.S.S. <i>Suiter</i>	
	U.S.S. <i>Moulton</i>	Dollond-class
NCC-3906	U.S.S. <i>Wrubel</i>	
	U.S.S. <i>Pogson</i>	Dollond-class
NCC-3907	U.S.S. <i>Tandley</i>	
	U.S.S. <i>Russell</i>	Dollond-class

NCC-3908	U.S.S. <i>Allred</i>	
	U.S.S. <i>Slipher</i>	Dollond-class
NCC-3909	U.S.S. <i>Hosea</i>	
	U.S.S. <i>Van De Hulst</i>	Dollond-class
NCC-3910	U.S.S. <i>Landis</i>	
	U.S.S. <i>Young</i>	Dollond-class
NCC-3911	U.S.S. <i>Bessel</i>	Dollond-class
NCC-3912	U.S.S. <i>Challis</i>	Dollond-class
NCC-3913	U.S.S. <i>Flamsteed</i>	Dollond-class
NCC-3914	U.S.S. <i>Henderson</i>	Dollond-class
NCC-3915	U.S.S. <i>Huggins</i>	Dollond-class
NCC-3916	U.S.S. <i>LaGrange</i>	Dollond-class
NCC-3916-A	U.S.S. <i>LaGrange</i>	MacPherson-class
NCC-3917	U.S.S. <i>Olbers</i>	Dollond-class
NCC-3918	U.S.S. <i>Plaskett</i>	Dollond-class
NCC-3919	U.S.S. <i>Sandage</i>	Dollond-class
NCC-3920	U.S.S. <i>Schawbe</i>	Dollond-class
NCC-3921	U.S.S. <i>Wolf</i>	Dollond-class
NCC-3921-B	U.S.S. <i>Einstein</i>	MacPherson-class
NCC-3921-C	U.S.S. <i>Wolf</i>	MacPherson-class
NCC-3922	U.S.S. <i>Bode</i>	Dollond-class
NCC-3923	U.S.S. <i>Chandrasekher</i>	Dollond-class
NCC-3924	U.S.S. <i>Eichelberger</i>	Dollond-class
NCC-3925	U.S.S. <i>Adams</i>	Dollond-class
NCC-2926	U.S.S. <i>Hall</i>	Dollond-class
NCC-3927	U.S.S. <i>Gold</i>	Dollond-class
NCC-3928	U.S.S. <i>Hoyle</i>	Dollond-class
NCC-3929	U.S.S. <i>Jeans</i>	Dollond-class
NCC-3930	U.S.S. <i>Langley</i>	Dollond-class
NCC-3931	U.S.S. <i>Pierce</i>	Dollond-class
NCC-3932	U.S.S. <i>Roques</i>	Dollond-class
NCC-3933	U.S.S. <i>Shapley</i>	Dollond-class
NCC-3934	U.S.S. <i>Todd</i>	Dollond-class
NCC-3935	U.S.S. <i>Baum</i>	Dollond-class
NCC-3936	U.S.S. <i>Carpenter</i>	Dollond-class
NCC-3937	U.S.S. <i>Delambre</i>	Dollond-class
NCC-3938	U.S.S. <i>Frost</i>	Dollond-class
NCC-3939	U.S.S. <i>Lowell</i>	Dollond-class
NCC-3940	U.S.S. <i>Van Maanen</i>	Dollond-class
NCC-3941	U.S.S. <i>Underwood</i>	Cheetah-class
NCC-4000	U.S.S. <i>Illustrator</i>	
NCC-4025	U.S.S. <i>Indus</i>	Indus-class
	Starship, the first of her class, a deuterium tanker. Launched in 2289, it was 236m long, 81m wide, 33m high and had a crew of 19.	
NCC-4115	U.S.S. <i>Paraná</i>	Indus-class
NCC-4116	U.S.S. <i>Mekong</i>	Indus-class
NCC-4117	U.S.S. <i>Rhein</i>	Indus-class

NCC-4118	U.S.S. <i>Thames</i>	Indus-class
NCC-4119	U.S.S. <i>Elbe</i>	Indus-class
NCC-4120	U.S.S. <i>Irtysch</i>	Indus-class
NCC-4193	U.S.S. <i>Pardici</i>	Andros-class
	Heavy cruiser commanded by Captain Roland McDaggett. After the ship was decommissioned, he actually bought the vessel.	
NCC-4200	U.S.S. <i>Trojan</i>	Trojan-class
	First starship of her class, a troop transport vessel.	
NCC-4201	U.S.S. <i>Dearmond</i>	Trojan-class
NCC-4202	U.S.S. <i>Edwards</i>	Trojan-class
NCC-4203	U.S.S. <i>Beecham</i>	Trojan-class
NCC-4204	U.S.S. <i>Faber</i>	Trojan-class
NCC-4205	U.S.S. <i>Judah</i>	Trojan-class
NCC-4206	U.S.S. <i>Bocaneger</i>	Trojan-class
NCC-4207	U.S.S. <i>Nguyan</i>	Trojan-class
NCC-4208	U.S.S. <i>Mainord</i>	Trojan-class
NCC-4209	U.S.S. <i>Evansen</i>	Trojan-class
NCC-4210	U.S.S. <i>Alomari</i>	Trojan-class
NCC-4211	U.S.S. <i>Porter</i>	Trojan-class
NCC-4212	U.S.S. <i>Karlan</i>	Trojan-class
NCC-4213	U.S.S. <i>Rhyne</i>	Trojan-class
NCC-4214	U.S.S. <i>Turman</i>	Trojan-class
NCC-4215	U.S.S. <i>Barrington</i>	Trojan-class
NCC-4216	U.S.S. <i>Pulliam</i>	Trojan-class
NCC-4217	U.S.S. <i>Callamateo</i>	Trojan-class
NCC-4218	U.S.S. <i>Strickland</i>	Trojan-class
NCC-4219	U.S.S. <i>Mazaratti</i>	Trojan-class
NCC-4220	U.S.S. <i>Keathley</i>	Trojan-class
NCC-4221	U.S.S. <i>Autry</i>	Trojan-class
NCC-4222	U.S.S. <i>Guyer</i>	Trojan-class
NCC-4223	U.S.S. <i>Tabor</i>	Trojan-class
NCC-4224	U.S.S. <i>Lacewell</i>	Trojan-class
NCC-4225	U.S.S. <i>Rabjohn</i>	Trojan-class
NCC-4226	U.S.S. <i>Avant</i>	Trojan-class
NCC-4227	U.S.S. <i>Nicholas</i>	Trojan-class
NCC-4228	U.S.S. <i>Padgett</i>	Trojan-class
NCC-4229	U.S.S. <i>Slyker</i>	Trojan-class
NCC-4230	U.S.S. <i>Dalrymple</i>	Trojan-class
NCC-4231	U.S.S. <i>Florer</i>	Trojan-class
NCC-4232	U.S.S. <i>Sowell</i>	Trojan-class
NCC-4233	U.S.S. <i>Addington</i>	Trojan-class
NCC-4234	U.S.S. <i>Melton</i>	Trojan-class
NCC-4235	U.S.S. <i>Gruben</i>	Trojan-class
NCC-4236	U.S.S. <i>Jenkins</i>	Trojan-class
NCC-4237	U.S.S. <i>Norrell</i>	Trojan-class
NCC-4238	U.S.S. <i>Furlough</i>	Trojan-class
NCC-4239	U.S.S. <i>Cardwell</i>	Trojan-class

NCC-4240	U.S.S. <i>Vanover</i>	Trojan-class
NCC-4241	U.S.S. <i>Bertreaux</i>	Trojan-class
NCC-4242	U.S.S. <i>Tillery</i>	Trojan-class
NCC-4243	U.S.S. <i>Lewis</i>	Trojan-class
NCC-4244	U.S.S. <i>Grafft</i>	Trojan-class
NCC-4245	U.S.S. <i>Ollison</i>	Trojan-class
NCC-4246	U.S.S. <i>Coulter</i>	Trojan-class
NCC-4247	U.S.S. <i>Gadison</i>	Trojan-class
NCC-4248	U.S.S. <i>Hagens</i>	Trojan-class
NCC-4249	U.S.S. <i>Zobac</i>	Trojan-class
NCC-4250	U.S.S. <i>Abercrombie</i>	Trojan-class
NCC-4251	U.S.S. <i>Wardrup</i>	Trojan-class
NCC-4252	U.S.S. <i>Overly</i>	Trojan-class
NCC-4253	U.S.S. <i>Jobe</i>	Trojan-class
NCC-4254	U.S.S. <i>Badgwell</i>	Trojan-class
NCC-4255	U.S.S. <i>Thiebuad</i>	Trojan-class
NCC-4256	U.S.S. <i>Linton</i>	Trojan-class
NCC-4257	U.S.S. <i>Pellette</i>	Trojan-class
NCC-4258	U.S.S. <i>Handford</i>	Trojan-class
NCC-4259	U.S.S. <i>Seger</i>	Trojan-class
NCC-4260	U.S.S. <i>Aylloonn</i>	Trojan-class
NCC-4261	U.S.S. <i>Osborn</i>	Trojan-class
NCC-4262	U.S.S. <i>Moran</i>	Trojan-class
NCC-4263	U.S.S. <i>Kiesling</i>	Trojan-class
NCC-4264	U.S.S. <i>Binder</i>	Trojan-class
NCC-4265	U.S.S. <i>Hallmark</i>	Trojan-class
NCC-4266	U.S.S. <i>Giveon</i>	Trojan-class
NCC-4267	U.S.S. <i>Aalbers</i>	Trojan-class
NCC-4300	U.S.S. <i>Larson</i>	Larson-class
	First starship of her class, a destroyer.	
	U.S.S. <i>Hensley</i>	Hensley-class
	First vessel of her class, a transport/tug vessel.	
	U.S.S. <i>Nelson</i>	Nelson-class
	Scout ship, first of her class	
NCC-4301	U.S.S. <i>Midway</i>	Larson-class
	U.S.S. <i>Kaufmann</i>	Hensley-class
NCC-4302	U.S.S. <i>Coral Sea</i>	Larson-class
	U.S.S. <i>Allegood</i>	Hensley-class
NCC-4303	U.S.S. <i>Tannenberg</i>	Larson-class
	U.S.S. <i>Kennedy</i>	Hensley-class
NCC-4304	U.S.S. <i>Trafalgar</i>	Larson-class
	U.S.S. <i>McCulluogh</i>	Hensley-class
NCC-4305	U.S.S. <i>Thelenth</i>	Larson-class
	U.S.S. <i>Fuller</i>	Hensley-class
NCC-4306	U.S.S. <i>Waterloo</i>	Larson-class
	U.S.S. <i>Medley</i>	Hensley-class

NCC-4307	U.S.S. <i>Borodino</i>	Larson-class
	U.S.S. <i>Frohwein</i>	Hensley-class
NCC-4308	U.S.S. <i>Austerlitz</i>	Larson-class
	U.S.S. <i>Stairhieme</i>	Hensley-class
NCC-4309	U.S.S. <i>Normandy</i>	Larson-class
	U.S.S. <i>Woodsinger</i>	Hensley-class
NCC-4310	U.S.S. <i>Marathon</i>	Larson-class
	U.S.S. <i>Allaway</i>	Hensley-class
NCC-4311	U.S.S. <i>Pharsalus</i>	Larson-class
	U.S.S. <i>Rabah</i>	Hensley-class
NCC-4312	U.S.S. <i>Cre'cy</i>	Larson-class
	U.S.S. <i>Grant</i>	Hensley-class
NCC-4313	U.S.S. <i>Poitiers</i>	Larson-class
	U.S.S. <i>Burnside</i>	Hensley-class
NCC-4314	U.S.S. <i>Agincourt</i>	Larson-class
	U.S.S. <i>Zierdt</i>	Hensley-class
NCC-4315	U.S.S. <i>Blenheim</i>	Larson-class
	U.S.S. <i>Wohlfelt</i>	Hensley-class
NCC-4316	U.S.S. <i>Torgau</i>	Larson-class
	U.S.S. <i>Mosely</i>	Hensley-class
NCC-4317	U.S.S. <i>Eylau</i>	Larson-class
	U.S.S. <i>Harvey</i>	Hensley-class
NCC-4318	U.S.S. <i>Casebolt</i>	Larson-class
NCC-4319	U.S.S. <i>Leyte</i>	Larson-class
	U.S.S. <i>Deere</i>	Hensley-class
NCC-4320	U.S.S. <i>Leipzig</i>	Larson-class
	U.S.S. <i>Meeler</i>	Hensley-class
NCC-4321	U.S.S. <i>Wiseley</i>	Larson-class
NCC-4322	U.S.S. <i>Buena Vista</i>	Larson-class
	U.S.S. <i>Torres</i>	Hensley-class
NCC-4323	U.S.S. <i>Garbo</i>	Larson-class
	U.S.S. <i>McGonogle</i>	Hensley-class
NCC-4324	U.S.S. <i>Gettysburg</i>	Larson-class
	U.S.S. <i>Ruble</i>	Hensley-class
NCC-4325	U.S.S. <i>Castinian</i>	Larson-class
	U.S.S. <i>Sylvester</i>	Hensley-class
NCC-4326	U.S.S. <i>Shiloh</i>	Larson-class
	U.S.S. <i>Jasper</i>	Hensley-class
NCC-4327	U.S.S. <i>Gallipoli</i>	Larson-class
	U.S.S. <i>Grelier</i>	Hensley-class
NCC-4328	U.S.S. <i>Jutland</i>	Larson-class
	U.S.S. <i>Boheme</i>	Hensley-class
NCC-4329	U.S.S. <i>Anzio</i>	Larson-class
	U.S.S. <i>Cheffer</i>	Hensley-class
NCC-4330	U.S.S. <i>Solar</i>	

NCC-4331	U.S.S. <i>Corregidor</i>	Larson-class
	U.S.S. <i>Waltman</i>	Hensley-class
NCC-4332	U.S.S. <i>Guadalcanal</i>	Larson-class
	U.S.S. <i>Van Winkle</i>	Hensley-class
NCC-4333	U.S.S. <i>Iwo Jima</i>	Larson-class
	U.S.S. <i>Joett</i>	Hensley-class
NCC-4334	U.S.S. <i>Okinawa</i>	Larson-class
	U.S.S. <i>Stanners</i>	Hensley-class
NCC-4335	U.S.S. <i>Ramses</i>	Larson-class
	U.S.S. <i>Chaffe</i>	Hensley-class
NCC-4336	U.S.S. <i>Thebes</i>	Larson-class
	U.S.S. <i>Eichhorst</i>	Hensley-class
NCC-4337	U.S.S. <i>Hammurabi</i>	Larson-class
	U.S.S. <i>Castille</i>	Hensley-class
NCC-4338	U.S.S. <i>Troy</i>	Larson-class
	U.S.S. <i>Armin</i>	Hensley-class
NCC-4339	U.S.S. <i>Chou</i>	Larson-class
	U.S.S. <i>Burkes</i>	Hensley-class
NCC-4340	U.S.S. <i>Xerxes</i>	Larson-class
	U.S.S. <i>Iccabod</i>	Hensley-class
NCC-4341	U.S.S. <i>Salami</i>	Larson-class
	U.S.S. <i>Nathan</i>	Hensley-class
NCC-4342	U.S.S. <i>Xenophon</i>	Larson-class
	U.S.S. <i>Chelsea</i>	Hensley-class
NCC-4343	U.S.S. <i>Julius Caesar</i>	Larson-class
	U.S.S. <i>Usher</i>	Hensley-class
NCC-4344	U.S.S. <i>Napoleon</i>	Larson-class
	U.S.S. <i>Kingsley</i>	Hensley-class
NCC-4345	U.S.S. <i>Cochise</i>	Larson-class
	U.S.S. <i>Bremmen</i>	Hensley-class
NCC-4346	U.S.S. <i>Lutzen</i>	Larson-class
	U.S.S. <i>Ian</i>	Hensley-class
NCC-4347	U.S.S. <i>Sun Tzu</i>	Larson-class
	U.S.S. <i>Rogers</i>	Hensley-class
NCC-4348	U.S.S. <i>Demetrius</i>	Larson-class
	U.S.S. <i>Prussia</i>	Hensley-class
NCC-4349	U.S.S. <i>Mead</i>	
NCC-4350	U.S.S. <i>Hannibal</i>	Larson-class
	U.S.S. <i>Quarles</i>	Hensley-class
NCC-4351	U.S.S. <i>Thermopylae</i>	Larson-class
	U.S.S. <i>White Sands</i>	Hensley-class
NCC-4352	U.S.S. <i>Scipio</i>	Larson-class
	U.S.S. <i>Yaude</i>	Hensley-class
NCC-4353	U.S.S. <i>Cannae</i>	Larson-class
	U.S.S. <i>Reasore</i>	Hensley-class

NCC-4354	U.S.S. <i>Alesia</i>	Larson-class
	U.S.S. <i>Isabella</i>	Hensley-class
NCC-4355	U.S.S. <i>Marc Antony</i>	Larson-class
	U.S.S. <i>Moravia</i>	Hensley-class
	U.S.S. <i>Kura</i>	Indus-class
NCC-4356	U.S.S. <i>Liu Pang</i>	Larson-class
	U.S.S. <i>Jones</i>	Hensley-class
	U.S.S. <i>Mackenzie</i>	Indus-class
NCC-4357	U.S.S. <i>Constantine</i>	Larson-class
	U.S.S. <i>Aberdeen</i>	Hensley-class
	U.S.S. <i>Ganges</i>	Indus-class
NCC-4358	U.S.S. <i>Alaric</i>	Larson-class
	U.S.S. <i>Copeland</i>	Hensley-class
	U.S.S. <i>Rio de la Plata</i>	Indus-class
NCC-4359	U.S.S. <i>Brooks</i>	
	U.S.S. <i>Daugava</i>	Indus-class
NCC-4360	U.S.S. <i>Orleans</i>	Larson-class
	U.S.S. <i>Terry</i>	Hensley-class
	U.S.S. <i>Limpopo</i>	Indus-class
NCC-4361	U.S.S. <i>Pendragon</i>	Larson-class
	U.S.S. <i>Chase</i>	Hensley-class
	U.S.S. <i>Murray</i>	Indus-class
NCC-4362	U.S.S. <i>Justinian</i>	Larson-class
	U.S.S. <i>Star Of India</i>	Hensley-class
	U.S.S. <i>Fleuve St. Laurent</i>	Indus-class
	U.S.S. <i>Tanager</i>	Mockingbird-class
	The first starship to explore and map the Retiklon Cluster, in 2292.	
NCC-4363	U.S.S. <i>Tiberius</i>	Larson-class
	U.S.S. <i>Francisco</i>	Hensley-class
	U.S.S. <i>Potomac</i>	Indus-class
NCC-4364	U.S.S. <i>Charlemagne</i>	Larson-class
	U.S.S. <i>Cathcart</i>	Hensley-class
	U.S.S. <i>Huang Ho</i>	Indus-class
NCC-4365	U.S.S. <i>Fleischman</i>	
	U.S.S. <i>Niger</i>	Indus-class
NCC-4366	U.S.S. <i>Jauhur</i>	Larson-class
	U.S.S. <i>Stripling</i>	Hensley-class
	U.S.S. <i>Oranje</i>	Indus-class
NCC-4367	U.S.S. <i>Alexander</i>	Larson-class
	U.S.S. <i>Ridenour</i>	Hensley-class
	U.S.S. <i>Arno</i>	Indus-class
NCC-4368	U.S.S. <i>Saladin</i>	Larson-class
	U.S.S. <i>Palermo</i>	Hensley-class
	U.S.S. <i>Douro</i>	Indus-class
NCC-4369	U.S.S. <i>Hardraade</i>	Larson-class
	U.S.S. <i>Bosnea</i>	Hensley-class
	U.S.S. <i>Krishna</i>	Indus-class

NCC-4370	U.S.S. <i>Mansfield</i>	
	U.S.S. <i>Büyük Menderes</i>	Indus-class
NCC-4371	U.S.S. <i>Frederick</i>	Larson-class
NCC-4372	U.S.S. <i>Acre</i>	Larson-class
NCC-4373	U.S.S. <i>Rajendra</i>	Larson-class
NCC-4374	U.S.S. <i>Behu</i>	Larson-class
NCC-4375	U.S.S. <i>Genghis Khan</i>	Larson-class
NCC-4376	U.S.S. <i>Liegnitz</i>	Larson-class
NCC-4377	U.S.S. <i>Cromwell</i>	Larson-class
NCC-4378	U.S.S. <i>Joan of Arc</i>	Larson-class
NCC-4379	U.S.S. <i>San Miguel</i>	Larson-class
NCC-4380	U.S.S. <i>Babur</i>	Larson-class
NCC-4381	U.S.S. <i>Hideyoshi</i>	Larson-class
NCC-4382	U.S.S. <i>Bayinnaung</i>	Larson-class
NCC-4383	U.S.S. <i>Cortez</i>	Larson-class
NCC-4384	U.S.S. <i>Tenochtitlan</i>	Larson-class
NCC-4385	U.S.S. <i>Adolphus</i>	Larson-class
NCC-4386	U.S.S. <i>de Tourville</i>	Larson-class
NCC-4387	U.S.S. <i>Breitenfeld</i>	Larson-class
NCC-4388	U.S.S. <i>Bradley</i>	Larson-class
NCC-4389	U.S.S. <i>Blake</i>	Larson-class
NCC-4391	U.S.S. <i>Nhat-Le</i>	Larson-class
NCC-4392	U.S.S. <i>Marlborough</i>	Larson-class
NCC-4393	U.S.S. <i>Ali Bey</i>	Larson-class
NCC-4394	U.S.S. <i>Washington</i>	Larson-class
NCC-4395	U.S.S. <i>Wellington</i>	Larson-class
NCC-4397	U.S.S. <i>Lafayette</i>	Larson-class
NCC-4398	U.S.S. <i>Murat</i>	Larson-class
NCC-4399	U.S.S. <i>Ney</i>	Larson-class
NCC-4400	U.S.S. <i>Von Blucher</i>	Larson-class
NCC-4401	U.S.S. <i>Khartoum</i>	Larson-class
NCC-4402	U.S.S. <i>Tecumseh</i>	Larson-class
NCC-4403	U.S.S. <i>Perry</i>	Larson-class
NCC-4404	U.S.S. <i>Hastings</i>	Larson-class
NCC-4405	U.S.S. <i>Jackson</i>	Larson-class
NCC-4407	U.S.S. <i>San Jacinto</i>	Larson-class
NCC-4408	U.S.S. <i>Palo Alto</i>	Larson-class
NCC-4409	U.S.S. <i>Scott</i>	Larson-class
NCC-4410	U.S.S. <i>Rommell</i>	Larson-class
NCC-4411	U.S.S. <i>Bolivar</i>	Larson-class
NCC-4412	U.S.S. <i>San Martin</i>	Larson-class
NCC-4413	U.S.S. <i>Boyaca</i>	Larson-class
NCC-4414	U.S.S. <i>Dewey</i>	Larson-class
NCC-4415	U.S.S. <i>Lee</i>	Larson-class
NCC-4416	U.S.S. <i>Grant</i>	Larson-class
NCC-4417	U.S.S. <i>Moltke</i>	Larson-class

NCC-4418	U.S.S. <i>Nakhimov</i>	Larson-class
NCC-4419	U.S.S. <i>Balaklava</i>	Larson-class
NCC-4420	U.S.S. <i>Dreyfus</i>	Larson-class
NCC-4421	U.S.S. <i>Mahdi</i>	Larson-class
NCC-4422	U.S.S. <i>Rorkes Drift</i>	Larson-class
NCC-4423	U.S.S. <i>Semmes</i>	Larson-class
NCC-4424	U.S.S. <i>Chief Joseph</i>	Larson-class
NCC-4426	U.S.S. <i>Hindenburg</i>	Larson-class
NCC-4427	U.S.S. <i>Foch</i>	Larson-class
NCC-4428	U.S.S. <i>Pershing</i>	Larson-class
NCC-4429	U.S.S. <i>Nicholas</i>	Larson-class
NCC-4430	U.S.S. <i>Kermal</i>	Larson-class
NCC-4431	U.S.S. <i>Oyama</i>	Larson-class
NCC-4432	U.S.S. <i>Pilsudski</i>	Larson-class
NCC-4433	U.S.S. <i>Port Arthur</i>	Larson-class
NCC-4434	U.S.S. <i>Tsushima</i>	Larson-class
NCC-4435	U.S.S. <i>Marne</i>	Larson-class
NCC-4436	U.S.S. <i>Richtofen</i>	Larson-class
NCC-4437	U.S.S. <i>MacArthur</i>	Larson-class
NCC-4438	U.S.S. <i>Montgomery</i>	Larson-class
NCC-4439	U.S.S. <i>Nimitz</i>	Larson-class
NCC-4440	U.S.S. <i>Zhukov</i>	Larson-class
NCC-4441	U.S.S. <i>Eisenhower</i>	Larson-class
NCC-4442	U.S.S. <i>Wavell</i>	Larson-class
NCC-4444	U.S.S. <i>Doenitz</i>	Larson-class
NCC-4445	U.S.S. <i>Tedder</i>	Larson-class
NCC-4447	U.S.S. <i>Kursk</i>	Larson-class
NCC-4448	U.S.S. <i>Axanar</i>	Larson-class
NCC-4449	U.S.S. <i>Collinswill</i>	Larson-class
NCC-4450	U.S.S. <i>Inchon</i>	Larson-class
NCC-4451	U.S.S. <i>Dayan</i>	Larson-class
NCC-4452	U.S.S. <i>Doermann</i>	Larson-class
NCC-4453	U.S.S. <i>Chryse</i>	Larson-class
NCC-4454	U.S.S. <i>Bursilev</i>	Larson-class
NCC-4455	U.S.S. <i>Titian Plain</i>	Larson-class
NCC-4456	U.S.S. <i>Kohlar</i>	Larson-class
NCC-4457	U.S.S. <i>Tana Re</i>	Larson-class
NCC-4458	U.S.S. <i>Conley</i>	Larson-class
NCC-4459	U.S.S. <i>Timoshenko</i>	Larson-class
NCC-4460	U.S.S. <i>Aquilar</i>	Larson-class
NCC-4461	U.S.S. <i>Stalingrad</i>	Larson-class
NCC-4462	U.S.S. <i>Imbrium</i>	Larson-class
NCC-4463	U.S.S. <i>Sheridan</i>	Larson-class
NCC-4464	U.S.S. <i>Choam</i>	Larson-class
NCC-4465	U.S.S. <i>Varistan</i>	Larson-class
NCC-4466	U.S.S. <i>Mooribunde</i>	Larson-class

NCC-4468	U.S.S. <i>Jones</i>	Larson-class
NCC-4469	U.S.S. <i>Petrovich</i>	Larson-class
NCC-4470	U.S.S. <i>Schultz</i>	Larson-class
NCC-4471	U.S.S. <i>Petaín</i>	Larson-class
NCC-4472	U.S.S. <i>de Gaulle</i>	Larson-class
NCC-4473	U.S.S. <i>Trenton</i>	Larson-class
NCC-4474	U.S.S. <i>Callisto</i>	Larson-class
NCC-4475	U.S.S. <i>Juno</i>	Larson-class
NCC-4598	U.S.S. <i>Fearless</i>	Excelsior-class
NCC-4600	U.S.S. <i>Lynx</i>	Lynx-class

Prototype of her class, intended to be a timeship.

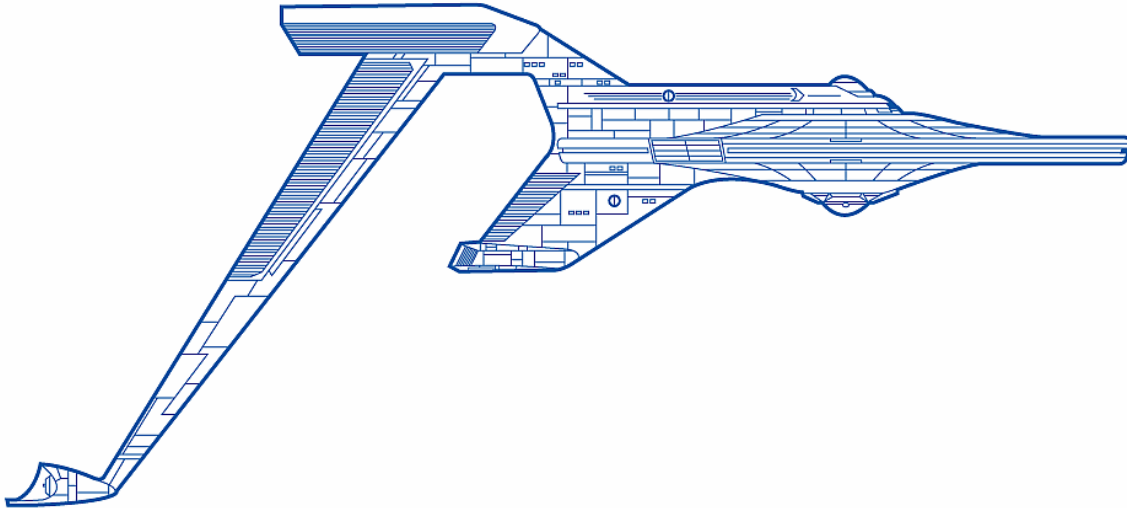

	U.S.S. <i>Hollingsworth</i>	Hollingsworth-class
	First starship of her class, a penetration cruiser.	
	U.S.S. <i>Hippocrates</i>	Hippocrates-class
	First vessel of her class, a medical frigate.	
NCC-4601	U.S.S. <i>Gordon</i>	
	U.S.S. <i>Cook</i>	Hollingsworth-class
NCC-4602	U.S.S. <i>Meadows</i>	
	U.S.S. <i>Kennard</i>	Hollingsworth-class
NCC-4603	U.S.S. <i>Jacinto</i>	
	U.S.S. <i>Campbell</i>	Hollingsworth-class
NCC-4604	U.S.S. <i>Barnett</i>	
	U.S.S. <i>McPhee</i>	Hollingsworth-class
NCC-4605	U.S.S. <i>Kamalpoor</i>	
NCC-4606	U.S.S. <i>Eckhoff</i>	
NCC-4607	U.S.S. <i>Isler</i>	
NCC-4608	U.S.S. <i>Beadless</i>	
NCC-4609	U.S.S. <i>Mabbit</i>	
NCC-4610	U.S.S. <i>Hamersley</i>	
NCC-4611	U.S.S. <i>Schultz</i>	
NCC-4612	U.S.S. <i>Eldredege</i>	Hippocrates-class
NCC-4613	U.S.S. <i>Richmond</i>	Hippocrates-class
NCC-4614	U.S.S. <i>Bagwell</i>	Hippocrates-class

NCC-4615	U.S.S. <i>Searls</i>	Hippocrates-class
NCC-4616	U.S.S. <i>Keeling</i>	
NCC-4617	U.S.S. <i>Faulkenberry</i>	Hippocrates-class
NCC-4618	U.S.S. <i>Garth</i>	Hippocrates-class
NCC-4619	U.S.S. <i>Walters</i>	Hippocrates-class
NCC-4620	U.S.S. <i>Bain</i>	Hippocrates-class
NCC-4621	U.S.S. <i>Zarate</i>	Hippocrates-class
NCC-4622	U.S.S. <i>Wexler</i>	Hippocrates-class
NCC-4623	U.S.S. <i>Helmbrecht</i>	Hippocrates-class
NCC-4624	U.S.S. <i>Mentor</i>	
NCC-4625	U.S.S. <i>Darsey</i>	Hippocrates-class
NCC-4626	U.S.S. <i>Varela</i>	Hippocrates-class
NCC-4627	U.S.S. <i>Gracie</i>	Hippocrates-class
NCC-4628	U.S.S. <i>Idalou</i>	Hippocrates-class
NCC-4629	U.S.S. <i>Etter</i>	Hippocrates-class
NCC-4630	U.S.S. <i>Yoder</i>	Hippocrates-class
NCC-4631	U.S.S. <i>Rodman</i>	Hippocrates-class
NCC-4632	U.S.S. <i>Warnock</i>	Hippocrates-class
NCC-4633	U.S.S. <i>Atkinson</i>	Hippocrates-class
NCC-4634	U.S.S. <i>Voight</i>	Hippocrates-class
NCC-4635	U.S.S. <i>Gabriel</i>	
NCC-4636	U.S.S. <i>Lynskey</i>	
NCC-4637	U.S.S. <i>Fairbanks</i>	Hippocrates-class
NCC-4638	U.S.S. <i>Slaughter</i>	Hippocrates-class
NCC-4639	U.S.S. <i>Kirby</i>	Hippocrates-class
NCC-4640	U.S.S. <i>Birdsall</i>	Hippocrates-class
NCC-4641	U.S.S. <i>Lawson</i>	
NCC-4642	U.S.S. <i>Kildare</i>	
NCC-4643	U.S.S. <i>Campsey</i>	Hippocrates-class
NCC-4644	U.S.S. <i>Nielson</i>	
NCC-4645	U.S.S. <i>Herndon</i>	Hippocrates-class
NCC-4646	U.S.S. <i>Ashbrook</i>	Hippocrates-class
NCC-4647	U.S.S. <i>Seagull</i>	Mockingbird-class
	Vessel that discovered five unclaimed, uninhabited class-M planets from 2294-2299.	
	U.S.S. <i>Trimble</i>	
NCC-4648	U.S.S. <i>Pictum</i>	Hippocrates-class
NCC-4649	U.S.S. <i>Davilla</i>	Hippocrates-class
NCC-4650	U.S.S. <i>Blackwood</i>	Hippocrates-class
NCC-4651	U.S.S. <i>Urive</i>	Hippocrates-class
NCC-4652	U.S.S. <i>Tilger</i>	Hippocrates-class
NCC-4653	U.S.S. <i>Kurth</i>	Hippocrates-class
NCC-4654	U.S.S. <i>Longoria</i>	Hippocrates-class
NCC-4655	U.S.S. <i>Caballero</i>	Hippocrates-class
NCC-4656	U.S.S. <i>Duvak</i>	Hippocrates-class
NCC-4657	U.S.S. <i>Nipper</i>	Hippocrates-class
NCC-4658	U.S.S. <i>Pabast</i>	Hippocrates-class

NCC-4659	U.S.S. <i>Lamberth</i>	Hippocrates-class
NCC-4660	U.S.S. <i>Quincy</i>	Hippocrates-class
NCC-4661	U.S.S. <i>Josephson</i>	Hippocrates-class
NCC-4662	U.S.S. <i>Acosta</i>	Hippocrates-class
NCC-4663	U.S.S. <i>Castleberry</i>	Hippocrates-class
NCC-4664	U.S.S. <i>Loran</i>	Hippocrates-class
NCC-4665	U.S.S. <i>Oliver</i>	Hippocrates-class
NCC-4666	U.S.S. <i>Julian</i>	Hippocrates-class
NCC-4667	U.S.S. <i>Labombard</i>	Hippocrates-class
NCC-4668	U.S.S. <i>Hinkley</i>	
NCC-4669	U.S.S. <i>Clampitt</i>	Hippocrates-class
NCC-4670	U.S.S. <i>Hoefler</i>	Hippocrates-class
NCC-4671	U.S.S. <i>Foerster</i>	Hippocrates-class
NCC-4672	U.S.S. <i>Dowdy</i>	Hippocrates-class
NCC-4673	U.S.S. <i>Abbott</i>	Hippocrates-class
NCC-4701	U.S.S. <i>Baker</i>	Baker-class
	Destroyer, first of her class.	
NCC-4801	U.S.S. <i>Starbird</i>	Starbird-class
	First vessel of her class, designated a battle cruiser.	
NCC-4825	U.S.S. <i>Niven</i>	Niven-class
	First starship of her class, designated a light attack cruiser.	
NCC-4826	U.S.S. <i>Yaachamos</i>	Niven-class
NCC-4827	U.S.S. <i>Barry</i>	Niven-class
NCC-4828	U.S.S. <i>Bourassa</i>	Niven-class
NCC-4829	U.S.S. <i>Ishtar</i>	Niven-class
NCC-4830	U.S.S. <i>Smith</i>	Niven-class
NCC-4831	U.S.S. <i>Ubermensch</i>	Niven-class
NCC-4832	U.S.S. <i>Kelley</i>	Niven-class
NCC-4833	U.S.S. <i>H'Karro</i>	Niven-class
NCC-4834	U.S.S. <i>Tikarmpo</i>	Niven-class
NCC-4835	U.S.S. <i>Kanner</i>	Niven-class
NCC-4836	U.S.S. <i>Leggett</i>	Niven-class
NCC-4837	U.S.S. <i>Felkl</i>	Niven-class
NCC-4838	U.S.S. <i>Anderson</i>	Niven-class
NCC-4839	U.S.S. <i>Bochneck</i>	Niven-class
NCC-4840	U.S.S. <i>Louis Wu</i>	Niven-class
NCC-4841	U.S.S. <i>Ralph</i>	Niven-class
NCC-4842	U.S.S. <i>Montgomery</i>	Niven-class
NCC-4843	U.S.S. <i>Shahtomata</i>	Niven-class
NCC-4844	U.S.S. <i>F. Josephs</i>	Niven-class
NCC-4845	U.S.S. <i>Braithwaite</i>	Niven-class
NCC-4846	U.S.S. <i>Callahan</i>	Niven-class
NCC-4847	U.S.S. <i>Demelo</i>	Niven-class
NCC-4848	U.S.S. <i>Boyington</i>	Niven-class
NCC-4849	U.S.S. <i>Adamcek</i>	Niven-class
NCC-4850	U.S.S. <i>Rommel</i>	Niven-class
NCC-4851	U.S.S. <i>Wakkadingho</i>	Niven-class

NCC-4852	U.S.S. <i>Robinson</i>	Niven-class
NCC-4853	U.S.S. <i>Fimmschaal</i>	Niven-class
NCC-4854	U.S.S. <i>Marchand</i>	Niven-class
NCC-4855	U.S.S. <i>Schneider</i>	Niven-class
NCC-4856	U.S.S. <i>Jein</i>	Niven-class
NCC-4857	U.S.S. <i>Bottke</i>	Niven-class
NCC-4858	U.S.S. <i>V'aacht</i>	Niven-class
NCC-4859	U.S.S. <i>Dart</i>	Niven-class
NCC-4867	U.S.S. <i>Achaea</i>	Grin'ki-class
	Tender assigned to Starbase 10.	
NCC-4869	U.S.S. <i>McGee</i>	Niven-class
NCC-4900	U.S.S. <i>Hellion</i>	Hellion-class
	First vessel of her class, a heavy destroyer.	
NCC-4901	U.S.S. <i>Montana</i>	Hellion-class
NCC-4902	U.S.S. <i>Hummel</i>	Hellion-class
NCC-4903	U.S.S. <i>Prestwich</i>	Hellion-class
NCC-4904	U.S.S. <i>Phantom</i>	Hellion-class
NCC-4905	U.S.S. <i>Davenport</i>	Hellion-class
NCC-4906	U.S.S. <i>Gauch</i>	Hellion-class
NCC-4907	U.S.S. <i>Martii</i>	Hellion-class
NCC-4908	U.S.S. <i>Robberson</i>	Hellion-class
NCC-4909	U.S.S. <i>Zywno</i>	Hellion-class
NCC-4910	U.S.S. <i>Lamar</i>	Hellion-class
NCC-4911	U.S.S. <i>Curret</i>	Hellion-class
NCC-4912	U.S.S. <i>Dameron</i>	Hellion-class
NCC-4913	U.S.S. <i>Gordan</i>	
NCC-4914	U.S.S. <i>Kesler</i>	Hellion-class
NCC-4915	U.S.S. <i>Baisden</i>	
NCC-4916	U.S.S. <i>Nieghman</i>	Hellion-class
NCC-4917	U.S.S. <i>Farrells</i>	Hellion-class
NCC-4918	U.S.S. <i>Sasso</i>	Hellion-class
NCC-4919	U.S.S. <i>Tucker</i>	Hellion-class
NCC-4920	U.S.S. <i>Glasco</i>	Hellion-class
NCC-4921	U.S.S. <i>Varren</i>	Hellion-class
NCC-4922	U.S.S. <i>Ragsdale</i>	Hellion-class
NCC-4923	U.S.S. <i>Warden</i>	Hellion-class
NCC-4924	U.S.S. <i>Harding</i>	Hellion-class
NCC-4925	U.S.S. <i>Ram</i>	Hellion-class
NCC-4973	U.S.S. <i>Javelin</i>	Andromeda-class
	Long-range exploration vessel.	
NCC-4987	U.S.S. <i>Camelot</i>	Benjamin Franklin-class
NCC-4988	U.S.S. <i>Beowulf</i>	Benjamin Franklin-class
NCC-4989	U.S.S. <i>Independence</i>	Benjamin Franklin-class
NCC-5000	U.S.S. <i>Anubus</i>	Anubis-class
	First vessel of her class, a scout ship.	
NCC-5001	U.S.S. <i>Hermes</i>	Anubis-class

NCC-5002

U.S.S. *Michael Adam*

Michael Adam-class

First vessel of her class, a scout ship.

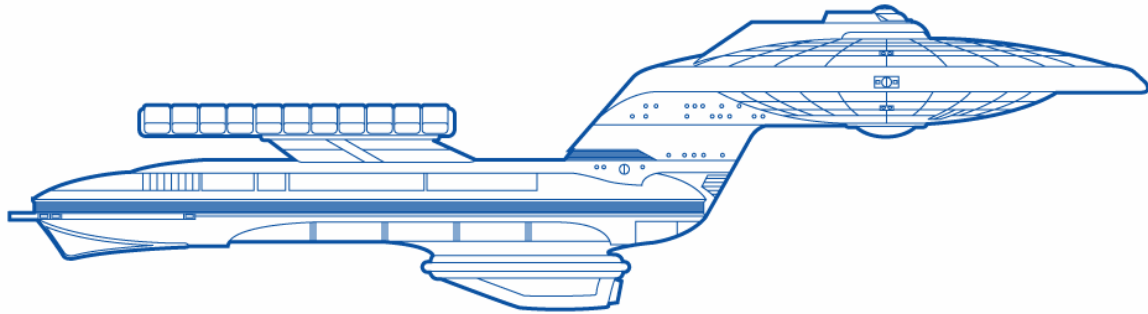

NCC-5003

U.S.S. *Aeolus*

Anubis-class

NCC-5004

U.S.S. *Diana*

Anubis-class

NCC-5004

U.S.S. *Quintillus*

Anubis-class

NCC-5005

U.S.S. *Bridger*

Anubis-class

NCC-5006

U.S.S. *Carson*

Anubis-class

NCC-5007

U.S.S. *Batidor*

Anubis-class

NCC-5008

U.S.S. *Cody*

Anubis-class

NCC-5009

U.S.S. *Revere*

Anubis-class

NCC-5010

U.S.S. *Spaker*

Anubis-class

NCC-5011

U.S.S. *Bowie*

Anubis-class

NCC-5012

U.S.S. *Sacajawea*

Anubis-class

NCC-5013

U.S.S. *Tonti*

Anubis-class

NCC-5014

U.S.S. *Crockett*

Anubis-class

NCC-5015

U.S.S. *Monoceros*

Anubis-class

NCC-5016

U.S.S. *Aries*

Anubis-class

NCC-5017

U.S.S. *Equulus*

Anubis-class

NCC-5018

U.S.S. *Lupus*

Anubis-class

NCC-5019

U.S.S. *Taurus*

Anubis-class

NCC-5020

U.S.S. *Camelopardus*

Anubis-class

NCC-5021

U.S.S. *Leo*

Anubis-class

NCC-5022

U.S.S. *Lynx*

Anubis-class

NCC-5023

U.S.S. *Ursa Major*

Anubis-class

NCC-5024

U.S.S. *Lepus*

Anubis-class

NCC-5025

U.S.S. *Canis Major*

Anubis-class

NCC-5026

U.S.S. *Pegasus*

Anubis-class

NCC-5027

U.S.S. *Vulpecula*

Anubis-class

NCC-5028

U.S.S. *Leo Minor*

Anubis-class

U.S.S. *Loki*

Loki-class

Destroyer, the first vessel of her class.

NCC-5029

U.S.S. *Canis Minor*

Anubis-class

NCC-5030

U.S.S. *Ursa Minor*

Anubis-class

NCC-5031

U.S.S. *Cygnus*

Anubis-class

NCC-5032

U.S.S. *Apus*

Anubis-class

NCC-5033

U.S.S. *Tucana*

Anubis-class

NCC-5034

U.S.S. *Corvus*

Anubis-class

NCC-5035

U.S.S. *Columbia*

Anubis-class

NCC-5036	U.S.S. <i>Pavo</i>	Anubis-class
NCC-5037	U.S.S. <i>Aquila</i>	Anubis-class
NCC-5038	U.S.S. <i>Grus</i>	Anubis-class
NCC-5039	U.S.S. <i>Phoenix</i>	Anubis-class
NCC-5040	U.S.S. <i>Rieger</i>	Anubis-class
NCC-5041	U.S.S. <i>Odell</i>	Anubis-class
NCC-5042	U.S.S. <i>Eckel</i>	Anubis-class
NCC-5043	U.S.S. <i>Thatcher</i>	Anubis-class
NCC-5044	U.S.S. <i>Olivas</i>	Anubis-class
NCC-5045	U.S.S. <i>Redwine</i>	Anubis-class
NCC-5046	U.S.S. <i>Jaekel</i>	Anubis-class
NCC-5047	U.S.S. <i>Sneed</i>	Anubis-class
NCC-5048	U.S.S. <i>Pace</i>	Anubis-class
NCC-5049	U.S.S. <i>Escalon</i>	Anubis-class
NCC-5050	U.S.S. <i>Rollins</i>	Anubis-class
NCC-5051	U.S.S. <i>Dykes</i>	Anubis-class
NCC-5052	U.S.S. <i>Timms</i>	Anubis-class
NCC-5053	U.S.S. <i>Appel</i>	Anubis-class
NCC-5054	U.S.S. <i>Parmeley</i>	Anubis-class
NCC-5055	U.S.S. <i>Jurik</i>	Anubis-class
NCC-5056	U.S.S. <i>Upshaw</i>	Anubis-class
NCC-5057	U.S.S. <i>Trice</i>	Anubis-class
NCC-5058	U.S.S. <i>Downing</i>	Anubis-class
NCC-5059	U.S.S. <i>Penoyer</i>	Anubis-class
NCC-5060	U.S.S. <i>Averitt</i>	Anubis-class
NCC-5061	U.S.S. <i>Taulbee</i>	Anubis-class
NCC-5062	U.S.S. <i>Keefer</i>	Anubis-class
NCC-5063	U.S.S. <i>Debnam</i>	Anubis-class
NCC-5064	U.S.S. <i>Northcutt</i>	Anubis-class
NCC-5065	U.S.S. <i>Kilpatrick</i>	Anubis-class
NCC-5066	U.S.S. <i>Baggett</i>	Anubis-class
NCC-5067	U.S.S. <i>Selby</i>	Anubis-class
NCC-5068	U.S.S. <i>Sartain</i>	Anubis-class
NCC-5069	U.S.S. <i>Dabilla</i>	Anubis-class
NCC-5070	U.S.S. <i>Quijada</i>	Anubis-class
NCC-5071	U.S.S. <i>Everitt</i>	Anubis-class
NCC-5072	U.S.S. <i>Vann</i>	Anubis-class
NCC-5073	U.S.S. <i>Borsch</i>	Anubis-class
NCC-5074	U.S.S. <i>Ramos</i>	Anubis-class
NCC-5075	U.S.S. <i>Maxheimer</i>	Anubis-class
NCC-5076	U.S.S. <i>Curry</i>	Anubis-class
NCC-5077	U.S.S. <i>Meurer</i>	Anubis-class
NCC-5078	U.S.S. <i>Fabila</i>	Anubis-class
NCC-5079	U.S.S. <i>Nausely</i>	Anubis-class
NCC-5080	U.S.S. <i>Burton</i>	Anubis-class
NCC-5081	U.S.S. <i>Lagrone</i>	Anubis-class

NCC-5082	U.S.S. <i>Maserang</i>	Anubis-class
NCC-5083	U.S.S. <i>Fiest</i>	Anubis-class
NCC-5084	U.S.S. <i>Leverett</i>	Anubis-class
	U.S.S. <i>Severn</i>	Indus-class
NCC-5085	U.S.S. <i>Carsten</i>	Anubis-class
	U.S.S. <i>Roanoke</i>	Indus-class
NCC-5086	U.S.S. <i>Marr</i>	Anubis-class
	U.S.S. <i>Shannon</i>	Indus-class
NCC-5087	U.S.S. <i>Haight</i>	Anubis-class
	U.S.S. <i>Guadalquivir</i>	Indus-class
NCC-5088	U.S.S. <i>Lohmann</i>	Anubis-class
	U.S.S. <i>Loire</i>	Indus-class
NCC-5089	U.S.S. <i>Forbes</i>	Anubis-class
	U.S.S. <i>Strymon</i>	Indus-class
NCC-5090	U.S.S. <i>Isham</i>	Anubis-class
	U.S.S. <i>Jordan</i>	Indus-class
NCC-5091	U.S.S. <i>Clauench</i>	Anubis-class
	U.S.S. <i>Onega</i>	Indus-class
NCC-5092	U.S.S. <i>Hamilton</i>	Anubis-class
	U.S.S. <i>Brahmaputra</i>	Indus-class
NCC-5093	U.S.S. <i>Gradel</i>	Anubis-class
	U.S.S. <i>Tigris</i>	Indus-class
NCC-5094	U.S.S. <i>Husemann</i>	Anubis-class
	U.S.S. <i>Amudarja</i>	Indus-class
NCC-5095	U.S.S. <i>Gillmore</i>	Anubis-class
	U.S.S. <i>Lena</i>	Indus-class
NCC-5096	U.S.S. <i>Ickes</i>	Anubis-class
	U.S.S. <i>Ob</i>	Indus-class
NCC-5097	U.S.S. <i>Conrad</i>	Anubis-class
NCC-5100	U.S.S. <i>Dakota</i>	Dakota-class
	Prototype of her class, a carrier.	
NCC-5101	U.S.S. <i>Kubala</i>	Dakota-class
NCC-5102	U.S.S. <i>Laird</i>	Dakota-class
NCC-5103	U.S.S. <i>Castillo</i>	Dakota-class
NCC-5104	U.S.S. <i>Gallendo</i>	Dakota-class
NCC-5105	U.S.S. <i>Memon</i>	Dakota-class
NCC-5106	U.S.S. <i>Armstrong</i>	Dakota-class
NCC-5107	U.S.S. <i>Jundt</i>	Dakota-class
NCC-5108	U.S.S. <i>Eilenberger</i>	Dakota-class
NCC-5109	U.S.S. <i>Oltmanns</i>	Dakota-class
NCC-5110	U.S.S. <i>Salcido</i>	Dakota-class
NCC-5111	U.S.S. <i>Baboyec</i>	Dakota-class
	U.S.S. <i>Babyel</i>	
NCC-5112	U.S.S. <i>Gomoke</i>	Dakota-class
NCC-5113	U.S.S. <i>Tasillo</i>	Dakota-class
NCC-5114	U.S.S. <i>Pickinpaugh</i>	Dakota-class
NCC-5115	U.S.S. <i>Coates</i>	Dakota-class

NCC-5116	U.S.S. <i>Hinds</i>	Dakota-class
NCC-5117	U.S.S. <i>Norris</i>	Dakota-class
	U.S.S. <i>Valor</i>	Constellation-class
NCC-5118	U.S.S. <i>Atchinson</i>	Dakota-class
NCC-5119	U.S.S. <i>Reddington</i>	Dakota-class
NCC-5120	U.S.S. <i>Washburn</i>	Dakota-class
NCC-5121	U.S.S. <i>Duff</i>	Dakota-class
NCC-5122	U.S.S. <i>Kastmann</i>	Dakota-class
NCC-5123	U.S.S. <i>Feagley</i>	Dakota-class
NCC-5124	U.S.S. <i>Bealer</i>	Dakota-class
NCC-5125	U.S.S. <i>Nutt</i>	Dakota-class
NCC-5126	U.S.S. <i>Monroe</i>	Dakota-class
NCC-5127	U.S.S. <i>Dockry</i>	Dakota-class
NCC-5128	U.S.S. <i>Langgood</i>	Dakota-class
NCC-5129	U.S.S. <i>Kingsberry</i>	Dakota-class
NCC-5130	U.S.S. <i>Alderson</i>	Dakota-class
NCC-5131	U.S.S. <i>Pompa</i>	Dakota-class
NCC-5132	U.S.S. <i>Ortiz</i>	Dakota-class
NCC-5133	U.S.S. <i>Slabotsky</i>	Dakota-class
NCC-5134	U.S.S. <i>Baillie</i>	Dakota-class
NCC-5135	U.S.S. <i>McPherson</i>	Dakota-class
NCC-5136	U.S.S. <i>Luceroo</i>	Dakota-class
NCC-5137	U.S.S. <i>Ayers</i>	Dakota-class
NCC-5138	U.S.S. <i>Rainey</i>	Dakota-class
NCC-5139	U.S.S. <i>Nees</i>	Dakota-class
NCC-5140	U.S.S. <i>Ochsenschlager</i>	Dakota-class
NCC-5141	U.S.S. <i>Coggburn</i>	Dakota-class
NCC-5142	U.S.S. <i>Kemper</i>	Dakota-class
NCC-5143	U.S.S. <i>Inkman</i>	Dakota-class
NCC-5144	U.S.S. <i>Paltan</i>	Dakota-class
NCC-5145	U.S.S. <i>Anneya</i>	Dakota-class
NCC-5146	U.S.S. <i>Zapata</i>	Dakota-class
NCC-5147	U.S.S. <i>Reitter</i>	Dakota-class
NCC-5148	U.S.S. <i>Neudorf</i>	Dakota-class
NCC-5149	U.S.S. <i>Daughtery</i>	Dakota-class
NCC-5150	U.S.S. <i>Etchison</i>	Dakota-class
NCC-5151	U.S.S. <i>Carmichael</i>	Dakota-class
NCC-5152	U.S.S. <i>Jackson</i>	Dakota-class
NCC-5153	U.S.S. <i>Henshall</i>	Dakota-class
NCC-5154	U.S.S. <i>Fletcher</i>	Dakota-class
NCC-5155	U.S.S. <i>Arnett</i>	Dakota-class
NCC-5181	U.S.S. <i>Anubis</i>	Anubis-class
	Starship, first of her class. A Though-deck carrier.	
NCC-5200	U.S.S. <i>Todega</i>	Todega-class
	First vessel of her class, designated a transport/tug.	
NCC-5300	U.S.S. <i>Abbe</i>	Abbe-class
	First vessel of her class, a PT Destroyer.	

NCC-5301	U.S.S. <i>Grattchi</i>	Abbe-class
NCC-5302	U.S.S. <i>Akkardi</i>	Abbe-class
NCC-5303	U.S.S. <i>Millian</i>	Abbe-class
NCC-5304	U.S.S. <i>Sketters</i>	Abbe-class
NCC-5305	U.S.S. <i>Winkler</i>	Abbe-class
NCC-5306	U.S.S. <i>Gipson</i>	Abbe-class
NCC-5307	U.S.S. <i>Jacka</i>	Abbe-class
NCC-5308	U.S.S. <i>Zhang</i>	Abbe-class
NCC-5309	U.S.S. <i>Xe</i>	Abbe-class
NCC-5310	U.S.S. <i>Edlin</i>	Abbe-class
NCC-5311	U.S.S. <i>Brittania</i>	Abbe-class
NCC-5312	U.S.S. <i>Esprey</i>	Abbe-class
NCC-5313	U.S.S. <i>Kelso</i>	Abbe-class
NCC-5314	U.S.S. <i>Wakinhutch</i>	Abbe-class
NCC-5315	U.S.S. <i>Maddox</i>	Abbe-class
NCC-5316	U.S.S. <i>Jenss</i>	Abbe-class
NCC-5317	U.S.S. <i>Caudle</i>	Abbe-class
NCC-5318	U.S.S. <i>Abbdoria</i>	Abbe-class
NCC-5319	U.S.S. <i>Paxton</i>	Abbe-class
NCC-5320	U.S.S. <i>Yearkiss</i>	Abbe-class
NCC-5371	U.S.S. <i>Lientorary</i>	Constellation-class
NCC-5382	U.S.S. <i>Shogun</i>	Shogun-class
	Light cruiser, the first vessel of her class. Developed at the 40-Eridani Fleet Yards, it was launched in 2307 with a crew of 180. The ship was 300m long, 172m wide and 49m high.	
NCC-5423	U.S.S. <i>Minsk</i>	Benjamin Franklin-class
NCC-5424	U.S.S. <i>Scharnhorst</i>	Benjamin Franklin-class
NCC-5488	U.S.S. <i>Axanar</i>	Constellation-class
NCC-5507	U.S.S. <i>Caspian</i>	
	Starfleet vessel, it was utilized in a Starfleet Academy training exercise after it's decommissioning.	
NCC-5518	U.S.S. <i>Arktika</i>	Benjamin Franklin-class
NCC-5519	U.S.S. <i>Hong Kong</i>	Benjamin Franklin-class
NCC-5572	U.S.S. <i>High Seas</i>	Constellation-class
NCC-5600	U.S.S. <i>Rosenzweig</i>	Rosenzweig-class
	First vessel of her class, an attack cruiser.	
NCC-5601	U.S.S. <i>Chavezorat</i>	Rosenzweig-class
NCC-5602	U.S.S. <i>Kendrick</i>	Rosenzweig-class
NCC-5603	U.S.S. <i>Wyble</i>	Rosenzweig-class
NCC-5604	U.S.S. <i>Botello</i>	Rosenzweig-class
NCC-5605	U.S.S. <i>Longanecker</i>	Rosenzweig-class
NCC-5606	U.S.S. <i>Quint</i>	Rosenzweig-class
NCC-5607	U.S.S. <i>Tippie</i>	Rosenzweig-class
NCC-5608	U.S.S. <i>Hutcherson</i>	Rosenzweig-class
NCC-5609	U.S.S. <i>Parkman</i>	Rosenzweig-class
NCC-5610	U.S.S. <i>Goggin</i>	Rosenzweig-class
NCC-5611	U.S.S. <i>Denning</i>	Rosenzweig-class

NCC-5612	U.S.S. <i>Raney</i>	Rosenzweig-class
NCC-5613	U.S.S. <i>Rebel</i>	Rosenzweig-class
NCC-5614	U.S.S. <i>Falkenbury</i>	Rosenzweig-class
NCC-5615	U.S.S. <i>Tabares</i>	Rosenzweig-class
NCC-5616	U.S.S. <i>Wheeler</i>	Rosenzweig-class
NCC-5617	U.S.S. <i>Enox</i>	Rosenzweig-class
NCC-5618	U.S.S. <i>Salazar</i>	Rosenzweig-class
NCC-5619	U.S.S. <i>Abercrombie</i>	Rosenzweig-class
NCC-5620	U.S.S. <i>Vannoy</i>	Rosenzweig-class
NCC-5621	U.S.S. <i>Zinsmeyer</i>	Rosenzweig-class
NCC-5622	U.S.S. <i>Joseph</i>	Rosenzweig-class
NCC-5623	U.S.S. <i>Montefusco</i>	Rosenzweig-class
NCC-5624	U.S.S. <i>Stevenson</i>	Rosenzweig-class
NCC-5625	U.S.S. <i>Yaeger</i>	Rosenzweig-class
NCC-5626	U.S.S. <i>Flygare</i>	Rosenzweig-class
NCC-5627	U.S.S. <i>Winger</i>	Rosenzweig-class
NX-5628	U.S.S. <i>Yamato</i>	Yamato-class
	Pathfinder vessel of her class.	
NCC-5699	U.S.S. <i>Vigilant</i>	Benjamin Franklin-class
NCC-5700	U.S.S. <i>Praha</i>	Benjamin Franklin-class
NCC-5813	U.S.S. <i>Amundsen</i>	Benjamin Franklin-class
NCC-5814	U.S.S. <i>Aurora</i>	Benjamin Franklin-class
NCC-6000	U.S.S. <i>Kodiak</i>	Kodiak-class
	Battleship, first vessel of her class.	
	U.S.S. <i>Matthew Decker</i>	Decker-class
	First starship of her class, designated a destroyer.	
NCC-6001	U.S.S. <i>Ilse</i>	
	U.S.S. <i>William Decker</i>	Decker-class
NCC-6002	U.S.S. <i>Fenter</i>	
	U.S.S. <i>Christopher Pike</i>	Decker-class
NCC-6003	U.S.S. <i>Hudnall</i>	
	U.S.S. <i>Robert April</i>	Decker-class
NCC-6004	U.S.S. <i>Overby</i>	
	U.S.S. <i>Kelvar Garth</i>	Decker-class
NCC-6005	U.S.S. <i>Elst Weinstein</i>	Ptolemy-class
	Transport vessel, the very first vessel Nyota Uhura served aboard during her long Starfleet career.	
	U.S.S. <i>Rorex</i>	
	U.S.S. <i>Jonathan T. Esteban</i>	Decker-class
NCC-6006	U.S.S. <i>Ellsworth</i>	
	U.S.S. <i>Clark Terrell</i>	Decker-class
NCC-6007	U.S.S. <i>Nations</i>	
	U.S.S. <i>Montgomery Scott</i>	Decker-class
NCC-6008	U.S.S. <i>Payne</i>	
	U.S.S. <i>Samara Uhura</i>	Decker-class
NCC-6009	U.S.S. <i>Arrington</i>	
	U.S.S. <i>Hikaru Sulu</i>	Decker-class

NCC-6010	U.S.S. <i>Vargas</i>	
	U.S.S. <i>Pavel Chekov</i>	Decker-class
NCC-6011	U.S.S. <i>Toeniskoetter</i>	
	U.S.S. <i>Koren Anastas</i>	Decker-class
NCC-6012	U.S.S. <i>Kelch</i>	
	U.S.S. <i>Damon West</i>	Decker-class
NCC-6013	U.S.S. <i>Sinclair</i>	
	U.S.S. <i>Anton Thiel</i>	Decker-class
NCC-6014	U.S.S. <i>Deavours</i>	
	U.S.S. <i>Yoshitomo Karasuma</i>	Decker-class
NCC-6015	U.S.S. <i>Quintanilla</i>	
	U.S.S. <i>Stephen Decatur</i>	Decker-class
NCC-6016	U.S.S. <i>Mason</i>	
	U.S.S. <i>Nathaniel Zar</i>	Decker-class
NCC-6017	U.S.S. <i>Josselet</i>	
	U.S.S. <i>Meredith Levette</i>	Decker-class
NCC-6018	U.S.S. <i>J.L. Lambert</i>	Decker-class
NCC-6019	U.S.S. <i>Zachary Holmes</i>	Decker-class
NCC-6020	U.S.S. <i>Kai-Jasik</i>	Decker-class
NCC-6021	U.S.S. <i>Peter Marlowe</i>	Decker-class
NCC-6022	U.S.S. <i>Jason Starion</i>	Decker-class
NCC-6023	U.S.S. <i>Malcolm Swain</i>	Decker-class
NCC-6024	U.S.S. <i>Andre LaSalle</i>	Decker-class
NCC-6025	U.S.S. <i>Connor Jacoby</i>	Decker-class
NCC-6026	U.S.S. <i>Surmass</i>	Decker-class
NCC-6027	U.S.S. <i>Peter Preston</i>	Decker-class
NCC-6028	U.S.S. <i>Dietrich Vinsel</i>	Decker-class
NCC-6029	U.S.S. <i>Myrr 'lin T'alon</i>	Decker-class
NCC-6030	U.S.S. <i>Archon Chovich</i>	Decker-class
	U.S.S. <i>Newton</i>	Newton-class

Research vessel, the first of her class. Crewed by 61 persons, the ship was launched in 2309. The ship was 151m long, 116m wide and 38m high.

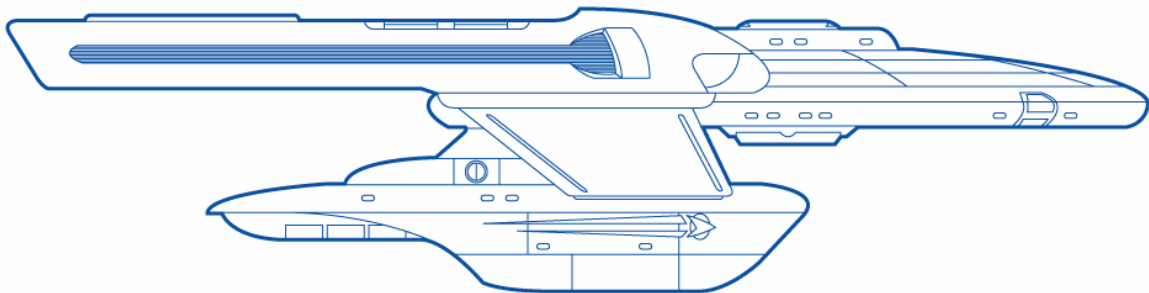

NCC-6031	U.S.S. <i>Stonwin</i>	Decker-class
NCC-6032	U.S.S. <i>Hieracho Naguro</i>	Decker-class
NCC-6033	U.S.S. <i>Lawrence Stiles</i>	Decker-class
NCC-6034	U.S.S. <i>Nherat</i>	Decker-class
NCC-6035	U.S.S. <i>Samantha Piper</i>	Decker-class
NCC-6036	U.S.S. <i>Mandala Flynn</i>	Decker-class

NCC-6037	U.S.S. <i>Irkin B'tly</i>	Decker-class
NCC-6038	U.S.S. <i>Libby Curtis</i>	Decker-class
NCC-6039	U.S.S. <i>Allison Vinson</i>	Decker-class
NX-6089	U.S.S. <i>Valiant</i>	Valiant-class
	Prototype of her class, designated an escort.	
NCC-6100	U.S.S. <i>Angueira</i>	Angueira-class
	Hospital vessel, first ship of her class.	

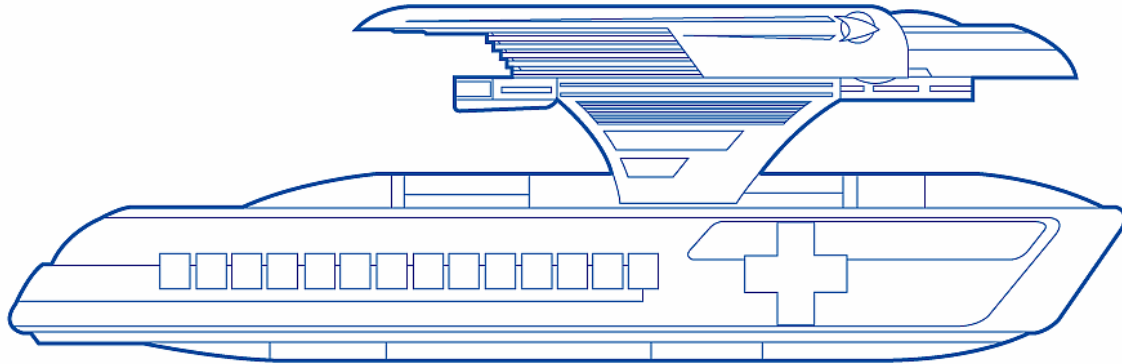

NCC-6101	U.S.S. <i>Cauley</i>	Angueira-class
NCC-6102	U.S.S. <i>Ellisson</i>	Angueira-class
NCC-6103	U.S.S. <i>Birdwell</i>	Angueira-class
NCC-6104	U.S.S. <i>Dickerson</i>	Angueira-class
NCC-6105	U.S.S. <i>Juarez</i>	Angueira-class
NCC-6106	U.S.S. <i>Avery</i>	Angueira-class
NCC-6107	U.S.S. <i>Karr</i>	Angueira-class
NCC-6108	U.S.S. <i>Edgemon</i>	Angueira-class
NCC-6109	U.S.S. <i>McAllister</i>	Angueira-class
NCC-6110	U.S.S. <i>Daffern</i>	Angueira-class
NCC-6111	U.S.S. <i>Flinn</i>	Angueira-class
NCC-6112	U.S.S. <i>Bartley</i>	Angueira-class
NCC-6113	U.S.S. <i>Hannabas</i>	Angueira-class
NCC-6114	U.S.S. <i>Newbro</i>	Angueira-class
NCC-6115	U.S.S. <i>Clardy</i>	Angueira-class
NCC-6116	U.S.S. <i>Hagstrom</i>	Angueira-class
NCC-6117	U.S.S. <i>Aycock</i>	Angueira-class
NCC-6118	U.S.S. <i>Redinger</i>	Angueira-class
NCC-6119	U.S.S. <i>Veretto</i>	Angueira-class
NCC-6120	U.S.S. <i>Dalton</i>	Angueira-class
NCC-6121	U.S.S. <i>Kageler</i>	Angueira-class
NCC-6122	U.S.S. <i>Efrenfeld</i>	Angueira-class
NCC-6123	U.S.S. <i>Matthews</i>	Angueira-class
NCC-6124	U.S.S. <i>Blake</i>	Angueira-class
NCC-6125	U.S.S. <i>Weatherby</i>	Angueira-class
NCC-6126	U.S.S. <i>Utterback</i>	Angueira-class
NCC-6127	U.S.S. <i>Conner</i>	Angueira-class
NCC-6128	U.S.S. <i>Earsley</i>	Angueira-class
NCC-6129	U.S.S. <i>Fisk</i>	Angueira-class

NCC-6130	U.S.S. <i>Deaver</i>	Angueira-class
NCC-6131	U.S.S. <i>Fogerson</i>	Angueira-class
NCC-6132	U.S.S. <i>Austin</i>	Angueira-class
NCC-6133	U.S.S. <i>Carroll</i>	Angueira-class
NCC-6134	U.S.S. <i>Harkrider</i>	Angueira-class
NCC-6135	U.S.S. <i>Elms</i>	Angueira-class
NCC-6136	U.S.S. <i>Giddens</i>	Angueira-class
NCC-6137	U.S.S. <i>Dugan</i>	Angueira-class
NCC-6138	U.S.S. <i>Palomo</i>	Angueira-class
NCC-6139	U.S.S. <i>Nazworth</i>	Angueira-class
NCC-6140	U.S.S. <i>Borst</i>	Angueira-class
NCC-6141	U.S.S. <i>Hackett</i>	Angueira-class
NCC-6142	U.S.S. <i>Leach</i>	Angueira-class
NCC-6143	U.S.S. <i>Eade</i>	Angueira-class
NCC-6144	U.S.S. <i>Keesee</i>	Angueira-class
NCC-6145	U.S.S. <i>Scoggin</i>	Angueira-class
NCC-6146	U.S.S. <i>Taylor</i>	Angueira-class
NCC-6147	U.S.S. <i>Ashley</i>	Angueira-class
NCC-6148	U.S.S. <i>Gonzales</i>	Angueira-class
NCC-6149	U.S.S. <i>Wetsel</i>	Angueira-class
NCC-6150	U.S.S. <i>Calfin</i>	Angueira-class
NCC-6151	U.S.S. <i>Walston</i>	Angueira-class
NCC-6152	U.S.S. <i>Obialo</i>	Angueira-class
NCC-6153	U.S.S. <i>Shaffer</i>	Angueira-class
NCC-6154	U.S.S. <i>Dyche</i>	Angueira-class
NCC-6155	U.S.S. <i>Gallimore</i>	Angueira-class
NCC-6156	U.S.S. <i>Brante</i>	Angueira-class
NCC-6157	U.S.S. <i>Kenneley</i>	Angueira-class
NCC-6158	U.S.S. <i>Logi</i>	Angueira-class
NCC-6159	U.S.S. <i>Popnoe</i>	Angueira-class
NCC-6160	U.S.S. <i>Garrett</i>	Angueira-class
NCC-6161	U.S.S. <i>Knarr</i>	Angueira-class
NCC-6162	U.S.S. <i>Aldacko</i>	Angueira-class
NCC-6163	U.S.S. <i>Erwin</i>	Angueira-class
NCC-6164	U.S.S. <i>Cottrell</i>	Angueira-class
NCC-6165	U.S.S. <i>Isaccs</i>	Angueira-class
NCC-6166	U.S.S. <i>Henegar</i>	Angueira-class
NCC-6167	U.S.S. <i>Featherston</i>	Angueira-class
NCC-6168	U.S.S. <i>Gustaves</i>	Angueira-class
NCC-6169	U.S.S. <i>Jung</i>	Angueira-class
NCC-6170	U.S.S. <i>Cabanas</i>	Angueira-class
NCC-6171	U.S.S. <i>Ezell</i>	Angueira-class
NCC-6172	U.S.S. <i>Baker</i>	Angueira-class
NCC-6173	U.S.S. <i>Laquey</i>	Angueira-class
NCC-6174	U.S.S. <i>Hunzeker</i>	Angueira-class
NCC-6175	U.S.S. <i>Ketron</i>	Angueira-class

NCC-6176	U.S.S. <i>Durrington</i>	Angueira-class
NCC-6177	U.S.S. <i>Graves</i>	Angueira-class
NCC-6178	U.S.S. <i>Cribbs</i>	Angueira-class
NCC-6179	U.S.S. <i>Burch</i>	Angueira-class
NCC-6180	U.S.S. <i>Ivey</i>	Angueira-class
NCC-6181	U.S.S. <i>Farley</i>	Angueira-class
NCC-6182	U.S.S. <i>Jamerson</i>	Angueira-class
NCC-6183	U.S.S. <i>Kidder</i>	Angueira-class
NCC-6184	U.S.S. <i>Balko</i>	Angueira-class
NCC-6185	U.S.S. <i>Estrada</i>	Angueira-class
NCC-6186	U.S.S. <i>Gregson</i>	Angueira-class
NCC-6187	U.S.S. <i>Feris</i>	Angueira-class
NCC-6188	U.S.S. <i>Jacobs</i>	Angueira-class
NCC-6189	U.S.S. <i>Hoffman</i>	Angueira-class
NCC-6190	U.S.S. <i>Culp</i>	Angueira-class
NCC-6191	U.S.S. <i>Falkenberg</i>	Angueira-class
NCC-6192	U.S.S. <i>Farley</i>	Angueira-class
NCC-6193	U.S.S. <i>Dworaczyk</i>	Angueira-class
NCC-6194	U.S.S. <i>Cunnigham</i>	Angueira-class
NCC-6195	U.S.S. <i>Everett</i>	Angueira-class
NCC-6196	U.S.S. <i>Abernathy</i>	Angueira-class
	U.S.S. <i>Deneva</i>	Deneva-class
	First starship of her class, commissioned in 2318. With eleven decks, the ship was 210m long and had a crew of 90. It is classified by the Fleet as a light transport vessel.	
NCC-6203	U.S.S. <i>LaSalle</i>	Deneva-class
	Vessel that discovered a series of radiation anomalies in the Gamma Arigulon system in 2367.	
NCC-6212	U.S.S. <i>Albion</i>	Excelsior-class
NCC-6237	U.S.S. <i>Arcos</i>	Deneva-class
	Freighter that suffered a warp-core breach near Turkana IV in 2367.	
NCC-6288	U.S.S. <i>Triumph</i>	Benjamin Franklin-class
NCC-6289	U.S.S. <i>Titan</i>	Benjamin Franklin-class
NCC-6290	U.S.S. <i>Illinois</i>	Benjamin Franklin-class
NCC-6291	U.S.S. <i>Lightning</i>	Benjamin Franklin-class
NCC-6400	U.S.S. <i>Lobo</i>	Lobo-class
	Prototype vessel, a though-deck carrier.	
NCC-6401	U.S.S. <i>Hensonard</i>	Lobo-class
NCC-6402	U.S.S. <i>Duncanardy</i>	Lobo-class
NCC-6403	U.S.S. <i>Jabor</i>	Lobo-class
NCC-6404	U.S.S. <i>Ombrellaro</i>	Lobo-class
NCC-6405	U.S.S. <i>Almeida</i>	Lobo-class
NCC-6406	U.S.S. <i>Scioli</i>	Lobo-class
NCC-6407	U.S.S. <i>Graha</i>	Lobo-class
NCC-6408	U.S.S. <i>Patsserter</i>	Lobo-class
NCC-6409	U.S.S. <i>Lamart</i>	Lobo-class
NCC-6410	U.S.S. <i>Hyland</i>	Lobo-class
NCC-6411	U.S.S. <i>Quintero</i>	Lobo-class

NCC-6412	U.S.S. <i>Boenat</i>	Lobo-class
NCC-6413	U.S.S. <i>Rickelard</i>	Lobo-class
NCC-6414	U.S.S. <i>Irick</i>	Lobo-class
NCC-6415	U.S.S. <i>Teinert</i>	Lobo-class
NCC-6416	U.S.S. <i>Esquivel</i>	Lobo-class
NCC-6417	U.S.S. <i>Urton</i>	Lobo-class
NCC-6418	U.S.S. <i>Crawflart</i>	Lobo-class
NCC-6419	U.S.S. <i>Masterman</i>	Lobo-class
NCC-6420	U.S.S. <i>Kuebler</i>	Lobo-class
NCC-6421	U.S.S. <i>Furney</i>	Lobo-class
NCC-6600	U.S.S. <i>Polaris</i>	Polaris-class
	Pathfinder vessel of her class, a light cruiser with a crew of 156. The ship was 364.84m long, 155.44m wide and 93.26m high.	
NCC-6627	U.S.S. <i>Lothron</i>	Byra-class
	Light cruiser that was decommissioned in 2358. The ship was purchased by a Terran entrepreneur in 2362.	
NCC-6661	U.S.S. <i>Crazy Horse</i>	Excelsior-class
NCC-6668	U.S.S. <i>Lightning</i>	
NCC-6677	U.S.S. <i>Portland</i>	Shogun-class
NCC-6678	U.S.S. <i>Mercury</i>	Shogun-class
NCC-6679	U.S.S. <i>Medusa</i>	Shogun-class
NCC-9790	U.S.S. <i>Falcon</i>	Constellation-class
NCC-6801	U.S.S. <i>Bader</i>	Bader-class
	Scout, first vessel of her class.	
NCC-6900	U.S.S. <i>Maxwell</i>	Maxwell-class
	First vessel of her class, a strike cruiser.	
NCC-6901	U.S.S. <i>Abrams</i>	
NCC-6902	U.S.S. <i>Zorola</i>	Maxwell-class
NCC-6903	U.S.S. <i>Faxton</i>	Maxwell-class
NCC-6904	U.S.S. <i>Funderburk</i>	Maxwell-class
NCC-6905	U.S.S. <i>Bradic</i>	Maxwell-class
NCC-6906	U.S.S. <i>Purkeypile</i>	Maxwell-class
NCC-6907	U.S.S. <i>Croofoot</i>	Maxwell-class
NCC-6908	U.S.S. <i>Grigsby</i>	Maxwell-class
NCC-6909	U.S.S. <i>Waclawczyk</i>	Maxwell-class
NCC-6910	U.S.S. <i>Jacobi</i>	Maxwell-class
NCC-6911	U.S.S. <i>Mojica</i>	Maxwell-class
NCC-6912	U.S.S. <i>Artiaga</i>	Maxwell-class
NCC-6913	U.S.S. <i>Pujari</i>	Maxwell-class
NCC-6914	U.S.S. <i>Breckenridge</i>	Maxwell-class
NCC-6915	U.S.S. <i>Gant</i>	Maxwell-class
NCC-6916	U.S.S. <i>Zenon</i>	Maxwell-class
NCC-6917	U.S.S. <i>Drabek</i>	Maxwell-class
NCC-6918	U.S.S. <i>Kreig</i>	Maxwell-class
NCC-6919	U.S.S. <i>Hagberg</i>	Maxwell-class
NCC-6920	U.S.S. <i>Cakir</i>	Maxwell-class
NCC-6921	U.S.S. <i>Godoy</i>	Maxwell-class

NCC-6922	U.S.S. <i>Villafranco</i>	Maxwell-class
NCC-6923	U.S.S. <i>Neskorik</i>	Maxwell-class
NCC-6924	U.S.S. <i>Leibfried</i>	Maxwell-class
NCC-6925	U.S.S. <i>Pinkerton</i>	Maxwell-class
NCC-6926	U.S.S. <i>Drennan</i>	Maxwell-class
NCC-6927	U.S.S. <i>Kesterson</i>	Maxwell-class
NCC-6928	U.S.S. <i>Ascension</i>	Maxwell-class
NCC-6929	U.S.S. <i>Zion</i>	Maxwell-class
NCC-6930	U.S.S. <i>O'Rourke</i>	Maxwell-class
NCC-6931	U.S.S. <i>Leatherbury</i>	Maxwell-class
NCC-6932	U.S.S. <i>Perales</i>	Maxwell-class
NCC-6933	U.S.S. <i>D'Souza</i>	Maxwell-class
NCC-6934	U.S.S. <i>Grabowski</i>	Maxwell-class
NCC-6935	U.S.S. <i>Walvood</i>	Maxwell-class
NCC-7000	U.S.S. <i>Curnow</i>	Curnow-class
	Starship, the first vessel of her class. A tactical cruiser.	
NCC-7017	U.S.S. <i>Amarillo</i>	Amarillo-class
	Cruiser, first of her class.	
NCC-7033	U.S.S. <i>LaFayette</i>	
	Starship commanded by Captain Anderson in 2287. The ship was a variation of a Miranda-class vessel.	
NCC-7075	U.S.S. <i>Assam</i>	Benjamin Franklin-class
NCC-7076	U.S.S. <i>Penelope</i>	Benjamin Franklin-class
NCC-7105	U.S.S. <i>Goodson</i>	Goodson-class
	Starship, the first of her class, a heavy cruiser.	
NCC-7144	U.S.S. <i>Asimov</i>	Newton-class
NCC-7145	U.S.S. <i>Faraday</i>	Newton-class
NCC-7146	U.S.S. <i>Gauss</i>	Newton-class
NCC-7147	U.S.S. <i>Armstrong</i>	Newton-class
NCC-7178	U.S.S. <i>Havana</i>	Cumberland-class
NCC-7206	U.S.S. <i>Galatea</i>	Irabazi-class
	Vessel assigned to Starbase 375 as a short-haul cargo/medical ship.	
NCC-7219	U.S.S. <i>Marco Polo</i>	Challenger-class
	Starship under the command of Captain Lyrida Halk. In 2367 the <i>Marco Polo</i> was attacked near the Beta Marada system.	
NCC-7228	U.S.S. <i>Armstrong</i>	
NCC-7400	U.S.S. <i>Maguellanes</i>	Maguellanes-class
	First vessel of her class, an escort cruiser.	
NCC-7401	U.S.S. <i>Ogan</i>	Maguellanes-class
NCC-7402	U.S.S. <i>Webb</i>	Maguellanes-class
NCC-7403	U.S.S. <i>Kneer</i>	Maguellanes-class
NCC-7404	U.S.S. <i>Allen</i>	Maguellanes-class
NCC-7405	U.S.S. <i>Shawgo</i>	Maguellanes-class
NCC-7406	U.S.S. <i>Ellerd</i>	Maguellanes-class
NCC-7407	U.S.S. <i>Demulemeester</i>	Maguellanes-class
NCC-7408	U.S.S. <i>Hathorn</i>	Maguellanes-class
NCC-7409	U.S.S. <i>Zaidi</i>	Maguellanes-class
NCC-7410	U.S.S. <i>Gilder</i>	Maguellanes-class

NCC-7411	U.S.S. <i>Kirksey</i>	Maguellanes-class
NCC-7412	U.S.S. <i>Vardy</i>	Maguellanes-class
NCC-7413	U.S.S. <i>Lester</i>	Maguellanes-class
NCC-7414	U.S.S. <i>Arthur</i>	Maguellanes-class
NCC-7415	U.S.S. <i>Mastke</i>	Maguellanes-class
NCC-7416	U.S.S. <i>Clayton</i>	Maguellanes-class
NCC-7417	U.S.S. <i>Infante</i>	Maguellanes-class
NCC-7418	U.S.S. <i>Pendgraft</i>	Maguellanes-class
NCC-7419	U.S.S. <i>Newell</i>	Maguellanes-class
NCC-7420	U.S.S. <i>Lemoine</i>	Maguellanes-class
NCC-7421	U.S.S. <i>Jonish</i>	Maguellanes-class
NCC-7422	U.S.S. <i>Mezack</i>	Maguellanes-class
NCC-7423	U.S.S. <i>Forde</i>	Maguellanes-class
NCC-7424	U.S.S. <i>Thorvilson</i>	Maguellanes-class
NCC-7425	U.S.S. <i>Clason</i>	Maguellanes-class
NCC-7426	U.S.S. <i>Yandell</i>	Maguellanes-class
NCC-7427	U.S.S. <i>Dawkins</i>	Maguellanes-class
NCC-7428	U.S.S. <i>Herod</i>	Maguellanes-class
NCC-7429	U.S.S. <i>Ickles</i>	Maguellanes-class
NCC-7430	U.S.S. <i>Quant</i>	Maguellanes-class
NCC-7431	U.S.S. <i>Edmunds</i>	Maguellanes-class
NCC-7432	U.S.S. <i>Gleghorn</i>	Maguellanes-class
NCC-7433	U.S.S. <i>Jorge</i>	Maguellanes-class
NCC-7434	U.S.S. <i>Beakley</i>	Maguellanes-class
NCC-7438	U.S.S. <i>Hyperion</i>	Excalibur-class
NX-7452	U.S.S. <i>Bailsong</i>	Bailsong-class
	First starship of her class.	
NCC-7700	U.S.S. <i>Gregory</i>	Gregory-class
	An exploration cruiser, first ship of her class.	
NCC-7701	U.S.S. <i>Diamant</i>	Gregory-class
NCC-7702	U.S.S. <i>Glenngary</i>	Gregory-class
	U.S.S. <i>Fek'Lar</i>	Fek'Lar-class
	Starship, the first of her class.	
NCC-7703	U.S.S. <i>Whiteside</i>	Gregory-class
NCC-7704	U.S.S. <i>Teeters</i>	Gregory-class
NCC-7705	U.S.S. <i>Dodson</i>	Gregory-class
NCC-7706	U.S.S. <i>Christofferson</i>	Gregory-class
NCC-7707	U.S.S. <i>Starks</i>	Gregory-class
NCC-7708	U.S.S. <i>Arant</i>	Gregory-class
NCC-7709	U.S.S. <i>Shepperd</i>	Gregory-class
NCC-7710	U.S.S. <i>Eaves</i>	Gregory-class
NCC-7711	U.S.S. <i>Brooker</i>	Gregory-class
NCC-7712	U.S.S. <i>Fonner</i>	Gregory-class
NCC-7713	U.S.S. <i>Sadler</i>	Gregory-class
NCC-7714	U.S.S. <i>Boteler</i>	Gregory-class
NCC-7715	U.S.S. <i>Gongora</i>	Gregory-class
NCC-7716	U.S.S. <i>Rackler</i>	Gregory-class

NCC-7717	U.S.S. <i>Haseloff</i>	Gregory-class
NCC-7718	U.S.S. <i>Arroyo</i>	Gregory-class
NCC-7719	U.S.S. <i>Quinones</i>	Gregory-class
NCC-7720	U.S.S. <i>Ibe</i>	Gregory-class
NCC-7721	U.S.S. <i>Chunn</i>	Gregory-class
NCC-7722	U.S.S. <i>Josie</i>	Gregory-class
NCC-7723	U.S.S. <i>Arnold</i>	Gregory-class
NCC-7724	U.S.S. <i>Perez</i>	Gregory-class
NCC-7725	U.S.S. <i>Killmer</i>	Gregory-class
NCC-7726	U.S.S. <i>Dennisson</i>	Gregory-class
NCC-7727	U.S.S. <i>McCane</i>	Gregory-class
NCC-7728	U.S.S. <i>Klepper</i>	Gregory-class
NCC-7729	U.S.S. <i>Zimbal</i>	Gregory-class
NCC-7730	U.S.S. <i>Mahurin</i>	Gregory-class
NCC-7731	U.S.S. <i>Layne</i>	Gregory-class
NCC-7732	U.S.S. <i>Enloe</i>	Gregory-class
NCC-7733	U.S.S. <i>Maunuksela</i>	Gregory-class
NCC-7734	U.S.S. <i>Yarina</i>	Gregory-class
NCC-7735	U.S.S. <i>Logsdon</i>	Gregory-class
NCC-7736	U.S.S. <i>Montross</i>	Gregory-class
NCC-7737	U.S.S. <i>Nemes</i>	Gregory-class
NCC-7738	U.S.S. <i>Foltyn</i>	Gregory-class
NCC-7739	U.S.S. <i>Warton</i>	Gregory-class
NCC-7740	U.S.S. <i>Oakeley</i>	Gregory-class
NCC-7741	U.S.S. <i>Lambert</i>	Gregory-class
NCC-7742	U.S.S. <i>Kearby</i>	Gregory-class
NCC-7743	U.S.S. <i>Vrana</i>	Gregory-class
NCC-7744	U.S.S. <i>Palmero</i>	Gregory-class
NCC-7745	U.S.S. <i>Goodloe</i>	Gregory-class
NCC-7746	U.S.S. <i>Jaso</i>	Gregory-class
NCC-7747	U.S.S. <i>Peugh</i>	Gregory-class
NCC-7748	U.S.S. <i>Usry</i>	Gregory-class
NCC-7749	U.S.S. <i>Iacuone</i>	Gregory-class
NCC-7750	U.S.S. <i>Romane</i>	Gregory-class
NCC-7751	U.S.S. <i>Heald</i>	Gregory-class
NCC-7752	U.S.S. <i>Haines</i>	Gregory-class
NCC-7753	U.S.S. <i>Templo</i>	Gregory-class
NCC-7754	U.S.S. <i>Rowel</i>	Gregory-class
NCC-7755	U.S.S. <i>Gandy</i>	Gregory-class
NCC-7756	U.S.S. <i>Inman</i>	Gregory-class
NCC-7757	U.S.S. <i>Saulk</i>	Gregory-class
NCC-7758	U.S.S. <i>Schniers</i>	Gregory-class
NCC-7759	U.S.S. <i>Franks</i>	Gregory-class
NCC-7760	U.S.S. <i>Jolivetti</i>	Gregory-class
NCC-7761	U.S.S. <i>Sleaser</i>	Gregory-class
NCC-7762	U.S.S. <i>Escobedo</i>	Gregory-class

NCC-7763	U.S.S. <i>Redman</i>	Gregory-class
NCC-7764	U.S.S. <i>Theamens</i>	Gregory-class
NCC-7765	U.S.S. <i>Dodkin</i>	Gregory-class
NCC-7766	U.S.S. <i>Knobel</i>	Gregory-class
NCC-7767	U.S.S. <i>Turnbow</i>	Gregory-class
NCC-7768	U.S.S. <i>Camposs</i>	Gregory-class
NCC-7769	U.S.S. <i>Quisenberry</i>	Gregory-class
NCC-7770	U.S.S. <i>Veitch</i>	Gregory-class
NCC-7771	U.S.S. <i>Beckner</i>	Gregory-class
NCC-7772	U.S.S. <i>Leserve</i>	Gregory-class
NCC-7773	U.S.S. <i>Alesch</i>	Gregory-class
NCC-7774	U.S.S. <i>Vo</i>	Gregory-class
NCC-7775	U.S.S. <i>Pickrel</i>	Gregory-class
NCC-7776	U.S.S. <i>Wallis</i>	Gregory-class
NCC-7777	U.S.S. <i>Maldonado</i>	Gregory-class
NCC-7778	U.S.S. <i>Yesell</i>	Gregory-class
NCC-7779	U.S.S. <i>Odle</i>	Gregory-class
NCC-7780	U.S.S. <i>Wigger</i>	Gregory-class
NCC-7781	U.S.S. <i>Yamak</i>	Gregory-class
NCC-7782	U.S.S. <i>Niemann</i>	Gregory-class
	U.S.S. <i>Pluto</i>	Benjamin Franklin-class
NCC-7850	U.S.S. <i>Ulysses</i>	Ulysses-class
	Pathfinder vessel of her class.	
NCC-8000	U.S.S. <i>Ambassador Hardin</i>	Ambassador Hardin-class
	First vessel of her class, a heavy cruiser.	
NCC-8001	U.S.S. <i>Danton Abrams</i>	Ambassador Hardin-class
NCC-8002	U.S.S. <i>Horatio Ballantrye</i>	Ambassador Hardin-class
NCC-8003	U.S.S. <i>President Survil</i>	Ambassador Hardin-class
NCC-8004	U.S.S. <i>Admiral Carnes</i>	Ambassador Hardin-class
NCC-8005	U.S.S. <i>Patricia Prince</i>	Ambassador Hardin-class
NCC-8006	U.S.S. <i>Beth Bigelow</i>	Ambassador Hardin-class
NCC-8007	U.S.S. <i>General A'thak</i>	Ambassador Hardin-class
NCC-8008	U.S.S. <i>Ambassador Crane</i>	Ambassador Hardin-class
NCC-8009	U.S.S. <i>Governor Gallas</i>	Ambassador Hardin-class
NCC-8010	U.S.S. <i>Fiona Vincent</i>	Ambassador Hardin-class
NCC-8011	U.S.S. <i>Garnash Trell</i>	Ambassador Hardin-class
NCC-8012	U.S.S. <i>Ibrahim Jones</i>	Ambassador Hardin-class
NCC-8013	U.S.S. <i>Andalusia Sims</i>	Ambassador Hardin-class
NCC-8014	U.S.S. <i>Koromondi Carstairs</i>	Ambassador Hardin-class
NCC-8196	U.S.S. <i>Arabia</i>	Benjamin Franklin-class
NCC-8197	U.S.S. <i>Morning Star</i>	Benjamin Franklin-class
NCC-8198	U.S.S. <i>Orlando</i>	Benjamin Franklin-class
NCC-8199	U.S.S. <i>Antioch</i>	Benjamin Franklin-class
NCC-8253	U.S.S. <i>Potempkin</i>	Excelsior-class
NCC-8294	U.S.S. <i>Endeavor</i>	
NCC-8298	U.S.S. <i>Keel</i>	Excelsior-class
	Starship, destroyed in 2366.	

NCC-8300	U.S.S. <i>Faron</i>	Faron-class
	Perimeter action ship, first of her class.	
NCC-8340	U.S.S. <i>Lancelot</i>	Lancelot-class
	Light cruiser, the first vessel of her class, launched in 2311. The ship had a crew compliment of 267. It was 351m long, 214m wide and 120m high.	
NCC-8400	U.S.S. <i>Anderson</i>	Anderson-class
	First starship of her class, a heavy scout.	
NCC-8401	U.S.S. <i>Maxey</i>	Anderson-class
NCC-8402	U.S.S. <i>Fallon</i>	Anderson-class
NCC-8403	U.S.S. <i>Arce</i>	Anderson-class
NCC-8404	U.S.S. <i>Pearce</i>	Anderson-class
NCC-8405	U.S.S. <i>Wolske</i>	Anderson-class
NCC-8406	U.S.S. <i>Carrow</i>	Anderson-class
NCC-8407	U.S.S. <i>Leigh</i>	Anderson-class
NCC-8408	U.S.S. <i>Walraven</i>	Anderson-class
NCC-8409	U.S.S. <i>Kristinek</i>	Anderson-class
NCC-8410	U.S.S. <i>Miller</i>	Anderson-class
NCC-8411	U.S.S. <i>Zaldivar</i>	Anderson-class
NCC-8412	U.S.S. <i>Williford</i>	Anderson-class
NCC-8413	U.S.S. <i>Yoakum</i>	Anderson-class
NCC-8414	U.S.S. <i>Chalfant</i>	Anderson-class
NCC-8415	U.S.S. <i>Utley</i>	Anderson-class
NCC-8416	U.S.S. <i>Tillmon</i>	Anderson-class
NCC-8417	U.S.S. <i>Ruthardt</i>	Anderson-class
NCC-8418	U.S.S. <i>Sterling</i>	Anderson-class
NCC-8419	U.S.S. <i>Brandon</i>	Anderson-class
NCC-8420	U.S.S. <i>Hall</i>	Anderson-class
NCC-8421	U.S.S. <i>Tennison</i>	Anderson-class
NCC-8422	U.S.S. <i>Schoenrock</i>	Anderson-class
NCC-8423	U.S.S. <i>Clausen</i>	Anderson-class
NCC-8424	U.S.S. <i>Rivers</i>	Anderson-class
NCC-8425	U.S.S. <i>Gisonno</i>	Anderson-class
NCC-8426	U.S.S. <i>Saldena</i>	Anderson-class
NCC-8427	U.S.S. <i>Pieper</i>	Anderson-class
NCC-8428	U.S.S. <i>Bogue</i>	Anderson-class
NCC-8429	U.S.S. <i>Ochoa</i>	Anderson-class
NCC-8430	U.S.S. <i>Hamblin</i>	Anderson-class
NCC-8431	U.S.S. <i>Gommorhea</i>	Anderson-class
NCC-8432	U.S.S. <i>Ramby</i>	Anderson-class
NCC-8433	U.S.S. <i>Peeples</i>	Anderson-class
NCC-8434	U.S.S. <i>Dabov</i>	Anderson-class
NCC-8435	U.S.S. <i>Nevarez</i>	Anderson-class
NCC-8436	U.S.S. <i>Giddeon</i>	Anderson-class
NCC-8437	U.S.S. <i>Overman</i>	Anderson-class
NCC-8438	U.S.S. <i>Beall</i>	Anderson-class
NCC-8439	U.S.S. <i>Neighly</i>	Anderson-class
NCC-8440	U.S.S. <i>Germany</i>	Anderson-class

NCC-8441	U.S.S. <i>Harrelson</i>	Anderson-class
NCC-8442	U.S.S. <i>Dennison-Flare</i>	Anderson-class
NCC-8443	U.S.S. <i>Maskew</i>	Anderson-class
NCC-8444	U.S.S. <i>Lokei</i>	Anderson-class
NCC-8445	U.S.S. <i>Gamble</i>	Anderson-class
NCC-8446	U.S.S. <i>Mahaffey</i>	Anderson-class
NCC-8447	U.S.S. <i>Dowell</i>	Anderson-class
NCC-8448	U.S.S. <i>Licon</i>	Anderson-class
	U.S.S. <i>Antioch</i>	
NCC-8449	U.S.S. <i>Gaasch</i>	Anderson-class
NCC-8450	U.S.S. <i>Higginbotham</i>	Anderson-class
NCC-8451	U.S.S. <i>Lehaman</i>	Anderson-class
NCC-8452	U.S.S. <i>Anuras</i>	Anderson-class
NCC-8453	U.S.S. <i>Kuhlmann</i>	Anderson-class
NCC-8454	U.S.S. <i>Furgeson</i>	Anderson-class
NCC-8455	U.S.S. <i>Labourdette</i>	Anderson-class
NCC-8456	U.S.S. <i>Holleron</i>	Anderson-class
NCC-8457	U.S.S. <i>Embry</i>	Anderson-class
NCC-8458	U.S.S. <i>Krauss</i>	Anderson-class
NCC-8459	U.S.S. <i>Fulbright</i>	Anderson-class
NCC-8460	U.S.S. <i>Keckler</i>	Anderson-class
NCC-8461	U.S.S. <i>Hudson Company</i>	Anderson-class
NCC-8462	U.S.S. <i>Ebeling</i>	Anderson-class
NCC-8463	U.S.S. <i>Kimble</i>	Anderson-class
NCC-8464	U.S.S. <i>Judd</i>	Anderson-class
NCC-8465	U.S.S. <i>Anglin</i>	Anderson-class
NCC-8466	U.S.S. <i>Hunker</i>	Anderson-class
NCC-8467	U.S.S. <i>Fodor</i>	Anderson-class
NCC-8468	U.S.S. <i>Idom</i>	Anderson-class
NCC-8469	U.S.S. <i>Joplin</i>	Anderson-class
NCC-8470	U.S.S. <i>Estorga</i>	Anderson-class
NCC-8471	U.S.S. <i>Jayroe</i>	Anderson-class
NCC-8472	U.S.S. <i>Fabela</i>	Anderson-class
NCC-8473	U.S.S. <i>Igo</i>	Anderson-class
NCC-8474	U.S.S. <i>Abney</i>	Anderson-class
NCC-8495	U.S.S. <i>Einstein</i>	Einstein-class
	Prototype time slip cruiser .	
NCC-8496	U.S.S. <i>LaPlace</i>	Einstein-class
NCC-8497	U.S.S. <i>Newton</i>	
NCC-8498	U.S.S. <i>Galileo</i>	
NCC-8499	U.S.S. <i>Hawking</i>	Einstein-class
NCC-8600	U.S.S. <i>Firestone</i>	Firestone-class
	First starship of the class, a battle cruiser.	
NCC-8601	U.S.S. <i>Thornley</i>	Firestone-class
NCC-8602	U.S.S. <i>Jolliff</i>	Firestone-class
NCC-8603	U.S.S. <i>Utmzn</i>	Firestone-class
NCC-8604	U.S.S. <i>Gooch</i>	Firestone-class

NCC-8605	U.S.S. <i>Scudder</i>	Firestone-class
NCC-8606	U.S.S. <i>Zahn</i>	Firestone-class
	Vessel assigned as a 24 th Century cadet training vessel at the Academy.	
NCC-8607	U.S.S. <i>Adkins</i>	Firestone-class
NCC-8608	U.S.S. <i>Bosket</i>	Firestone-class
NCC-8609	U.S.S. <i>Kolar</i>	Firestone-class
NCC-8610	U.S.S. <i>Yang</i>	Firestone-class
NCC-8611	U.S.S. <i>Harvick</i>	Firestone-class
NCC-8612	U.S.S. <i>Cooper</i>	Firestone-class
NCC-8613	U.S.S. <i>Lichtenhahn</i>	Firestone-class
NCC-8614	U.S.S. <i>Frazier</i>	Firestone-class
NCC-8615	U.S.S. <i>Alm</i>	Firestone-class
NCC-8616	U.S.S. <i>Fondren</i>	Firestone-class
NCC-8617	U.S.S. <i>Gist</i>	Firestone-class
NCC-8618	U.S.S. <i>Neill</i>	Firestone-class
NCC-8619	U.S.S. <i>Welsh</i>	Firestone-class
NCC-8620	U.S.S. <i>Durrett</i>	Firestone-class
NCC-8621	U.S.S. <i>Clary</i>	Firestone-class
NCC-8622	U.S.S. <i>Rios</i>	Firestone-class
NCC-8623	U.S.S. <i>Diaz</i>	Firestone-class
NCC-8624	U.S.S. <i>Bornick</i>	Firestone-class
NCC-8625	U.S.S. <i>Estill</i>	Firestone-class
NCC-8626	U.S.S. <i>Ojeda</i>	Firestone-class
NCC-8627	U.S.S. <i>Hiltbrunner</i>	Firestone-class
NCC-8628	U.S.S. <i>Means</i>	Firestone-class
NCC-8629	U.S.S. <i>Almack</i>	Firestone-class
NCC-8702	U.S.S. <i>Explorer</i>	
NCC-8712	U.S.S. <i>Avatar</i>	Galliant-class
NCC-8735	U.S.S. <i>Adelaide</i>	Firestone-class
NCC-8736	U.S.S. <i>Dornier</i>	Firestone-class
NCC-8737	U.S.S. <i>Bamaka</i>	Firestone-class
NCC-8738	U.S.S. <i>Guadalajara</i>	Firestone-class
NCC-8739	U.S.S. <i>Karinga</i>	Firestone-class
NCC-8740	U.S.S. <i>Rangoon</i>	Firestone-class
NCC-8741	U.S.S. <i>Hamilton</i>	Firestone-class
NCC-8742	U.S.S. <i>Jakarta</i>	Firestone-class
NCC-8743	U.S.S. <i>Effhamiqua</i>	Firestone-class
NCC-8744	U.S.S. <i>Saberhagen</i>	Saberhagen-class
	Defense-substation.	
NCC-8745	U.S.S. <i>McCaffrey</i>	Saberhagen-class
NCC-8746	U.S.S. <i>Bandung</i>	Saberhagen-class
NCC-8747	U.S.S. <i>Quimerto</i>	Saberhagen-class
NCC-8748	U.S.S. <i>Campinas</i>	Saberhagen-class
NCC-8749	U.S.S. <i>Tripoli</i>	Saberhagen-class
NCC-8750	U.S.S. <i>Khabaravoshka</i>	Saberhagen-class
NCC-8751	U.S.S. <i>Ibadan</i>	Saberhagen-class
NCC-8752	U.S.S. <i>Fujikoras</i>	Saberhagen-class

NCC-8753	U.S.S. <i>Vancouver</i>	Saberhagen-class
NCC-8754	U.S.S. <i>Arquette</i>	Saberhagen-class
NCC-8755	U.S.S. <i>Mu-urashta</i>	Saberhagen-class
NCC-8756	U.S.S. <i>Tabriz</i>	Saberhagen-class
NCC-8757	U.S.S. <i>Novokuznetski</i>	Saberhagen-class
NCC-8759	U.S.S. <i>Saratov</i>	Saberhagen-class
NCC-8760	U.S.S. <i>Xi'an</i>	Saberhagen-class
NCC-8761	U.S.S. <i>Griffen</i>	Saberhagen-class
NCC-8762	U.S.S. <i>Imarquella</i>	Saberhagen-class
NCC-8763	U.S.S. <i>Bursa</i>	Saberhagen-class
NCC-8764	U.S.S. <i>Kwangju</i>	Saberhagen-class
NCC-8765	U.S.S. <i>Zaragoza</i>	Saberhagen-class
NCC-8766	U.S.S. <i>Perth</i>	Saberhagen-class
NCC-8767	U.S.S. <i>Odessa</i>	Saberhagen-class
NCC-8768	U.S.S. <i>Shen-ti-yang</i>	Saberhagen-class
NCC-8769	U.S.S. <i>Chang-chun</i>	Saberhagen-class
NCC-8770	U.S.S. <i>Urbaque</i>	Saberhagen-class
NCC-8771	U.S.S. <i>Lanier</i>	Saberhagen-class
NCC-8772	U.S.S. <i>Osaka</i>	Saberhagen-class
NCC-8773	U.S.S. <i>Volgograminski</i>	Saberhagen-class
NCC-8774	U.S.S. <i>Melbourne</i>	Saberhagen-class
NCC-8775	U.S.S. <i>Santo Domingo</i>	Saberhagen-class
NCC-8776	U.S.S. <i>Lyon</i>	Saberhagen-class
NCC-8777	U.S.S. <i>Thon</i>	Saberhagen-class
NCC-8778	U.S.S. <i>Sheffield</i>	Saberhagen-class
NCC-8779	U.S.S. <i>Leeds</i>	Saberhagen-class
NCC-8780	U.S.S. <i>Rostovoshka</i>	Saberhagen-class
NCC-8781	U.S.S. <i>Newcastle</i>	Saberhagen-class
NCC-8782	U.S.S. <i>T'aixuantis</i>	Saberhagen-class
NCC-8783	U.S.S. <i>Dar es salaam</i>	Saberhagen-class
NCC-8888	U.S.S. <i>Galileo</i>	Galileo-class
	Starship, first vessel of her class, launched in 2307. Designated a cruiser.	
NCC-8889	U.S.S. <i>Albert Einstein</i>	Galileo-class
NCC-8890	U.S.S. <i>James Cook</i>	Galileo-class
NCC-8891	U.S.S. <i>Chadrsekhar</i>	Galileo-class
NCC-8892	U.S.S. <i>Ferdinand Magellan</i>	Galileo-class
NCC-8893	U.S.S. <i>Jacques Ives Cousteau</i>	Galileo-class
NCC-8894	U.S.S. <i>Leonardo Da Vinci</i>	Galileo-class
NCC-8895	U.S.S. <i>Zephram Cochrane</i>	Galileo-class
NCC-8896	U.S.S. <i>Nicholaus Copernicus</i>	Galileo-class
NCC-8897	U.S.S. <i>Carolus Linneus</i>	Galileo-class
NCC-8898	U.S.S. <i>Paul A M Dirac</i>	Galileo-class
NCC-8899	U.S.S. <i>Stephen W Hawking</i>	Galileo-class
NCC-8900	U.S.S. <i>Pascal</i>	Newton-class
NCC-8901	U.S.S. <i>Nansen</i>	Newton-class
NCC-8902	U.S.S. <i>Heron</i>	Newton-class
NCC-8903	U.S.S. <i>Robert Scott</i>	Newton-class

NCC-9000	U.S.S. <i>Thomas Paine</i> First vessel of her class, designated a frigate.	Thomas Paine-class
NCC-9001	U.S.S. <i>Constantine Rill</i>	Thomas Paine-class
NCC-9002	U.S.S. <i>Bartholemew Dynass</i>	Thomas Paine-class
NCC-9003	U.S.S. <i>Amalthea Rex</i>	Thomas Paine-class
NCC-9004	U.S.S. <i>Preston King</i>	Thomas Paine-class
NCC-9005	U.S.S. <i>Shanesssa</i>	Thomas Paine-class
NCC-9006	U.S.S. <i>Sundrass</i>	Thomas Paine-class
NCC-9007	U.S.S. <i>Grundjaki</i>	Thomas Paine-class
NCC-9008	U.S.S. <i>Paul Gable</i>	Thomas Paine-class
NCC-9009	U.S.S. <i>Falmor Hann</i>	Thomas Paine-class
NCC-9010	U.S.S. <i>Halcyon</i>	Thomas Paine-class
NCC-9011	U.S.S. <i>Christopher Dundas</i>	Thomas Paine-class
NCC-9012	U.S.S. <i>Canadara</i>	Thomas Paine-class
NCC-9013	U.S.S. <i>Carla Winterspoon</i>	Thomas Paine-class
NCC-9014	U.S.S. <i>Drakendesh</i>	Thomas Paine-class
NCC-9015	U.S.S. <i>Sedgemoor Tann</i>	Thomas Paine-class
NCC-9016	U.S.S. <i>Samantha Elass</i>	Thomas Paine-class
NCC-9017	U.S.S. <i>Tamara</i>	Thomas Paine-class
NCC-9018	U.S.S. <i>Pride of Elass</i>	Thomas Paine-class
NCC-9019	U.S.S. <i>Pride of Troyass</i>	Thomas Paine-class
NCC-9020	U.S.S. <i>Cransston Juriss</i>	Thomas Paine-class
NCC-9021	U.S.S. <i>Quintaus Gall</i>	Thomas Paine-class
NCC-9022	U.S.S. <i>Ramana Loris</i>	Thomas Paine-class
NCC-9023	U.S.S. <i>Essex Prinn</i>	Thomas Paine-class
NCC-9024	U.S.S. <i>Michael Whelan</i>	
NX-9111	U.S.S. <i>Excentric</i> Starship, the first vessel of her class.	Excentric-class
NCC-9134	U.S.S. <i>Justice</i>	Lancelot-class
NCC-9700	U.S.S. <i>Hornet</i> First vessel of her class, a carrier vessel.	Hornet-class
NCC-9701	U.S.S. <i>Aries</i>	Hornet-class
NCC-9702	U.S.S. <i>Octantis</i>	Hornet-class
NCC-9703	U.S.S. <i>Scorpius</i>	Hornet-class
NCC-9704	U.S.S. <i>Dorado</i>	Hornet-class
	U.S.S. <i>Sirius</i> Starship, first of her class, designated a light cruiser. The ship, launched in 2313, had a crew compliment of 292. It was 383m long, 214m wide and 87m high.	Sirius-class
NCC-9705	U.S.S. <i>Sagitta</i>	Hornet-class
NCC-9706	U.S.S. <i>Caeli</i>	Hornet-class
NCC-9707	U.S.S. <i>Leporis</i>	Hornet-class
NCC-9708	U.S.S. <i>Carina</i>	Hornet-class
NCC-9709	U.S.S. <i>Fornax</i>	Hornet-class
NCC-9754	U.S.S. <i>Victory</i> Starship under the command of Captain Zimbata, Geordi LaForge served aboard the <i>Victory</i> early in his career.	Constellation-class
NCC-9761	U.S.S. <i>Gihlan</i>	Constellation-class

NCC-9788	U.S.S. <i>Barracuda</i>	Barracuda-class
	Scout ship, the first vessel of her class, launched in 2314. The ship was 155m long, 94m wide and 36m high. The ship's crew compliment was 32 crew.	
NCC-9798	U.S.S. <i>Revere</i>	Barracuda-class
NCC-9808	U.S.S. <i>Antion</i>	Moreau-class
	Second starship of her class.	
NCC-9866	U.S.S. <i>Cleveland</i>	Sirius-class
NCC-9867	U.S.S. <i>Brooklyn</i>	Sirius-class
NCC-9872	U.S.S. <i>Zeppelin</i>	Newton-class
NCC-9873	U.S.S. <i>Piccard</i>	Newton-class
NCC-9874	U.S.S. <i>Lovell</i>	Newton-class
NCC-9991	U.S.S. <i>Budapest</i>	Barracuda-class
NCC-9992	U.S.S. <i>Greyhound</i>	Barracuda-class
NCC-10000	U.S.S. <i>M'Benga</i>	M'Benga-class
	First starship of her class, a medical cruiser.	
NCC-10001	U.S.S. <i>Salk</i>	M'Benga-class
NCC-10002	U.S.S. <i>Steuben</i>	M'Benga-class
NCC-10003	U.S.S. <i>Pasteur</i>	M'Benga-class
NCC-10004	U.S.S. <i>Voris</i>	M'Benga-class
NCC-10005	U.S.S. <i>Crenshaw</i>	M'Benga-class
NCC-10006	U.S.S. <i>Shenvala</i>	M'Benga-class
NCC-10007	U.S.S. <i>Barnard</i>	M'Benga-class
NCC-10008	U.S.S. <i>Watson</i>	
NCC-10009	U.S.S. <i>Crick</i>	M'Benga-class
NCC-10010	U.S.S. <i>Van Gelder</i>	M'Benga-class
NCC-10011	U.S.S. <i>T'Klyrn</i>	M'Benga-class
NCC-10012	U.S.S. <i>Hopewell</i>	M'Benga-class
NCC-10019	U.S.S. <i>Golden Hind</i>	
	A high speed courier shuttle, it had three warp engine nacelles.	
NCC-10037	U.S.S. <i>Greyhound</i>	
NCC-10376	U.S.S. <i>Hermes</i>	Antares-class
	One of several vessels to bear the name, the <i>Hermes</i> served in Captain Jean-Luc Picard's armada to blockade the Romulan supply ships that were supplying the Duras family during the Klingon civil war of 2367-68.	
NCC-10397	U.S.S. <i>Trafalgar</i>	Sirius-class
NCC-10398	U.S.S. <i>Superior</i>	Sirius-class
NCC-10399	U.S.S. <i>Hawk</i>	Sirius-class
NCC-10400	U.S.S. <i>Aldebaran</i>	Sirius-class

NCC-10521

U.S.S. *Ambassador*

Ambassador-class

Pathfinder vessel of her class, the ship was launched in 2322. 526m long, the ship was originally registered NX-10521. It had 40 decks and a crew compliment of 900.

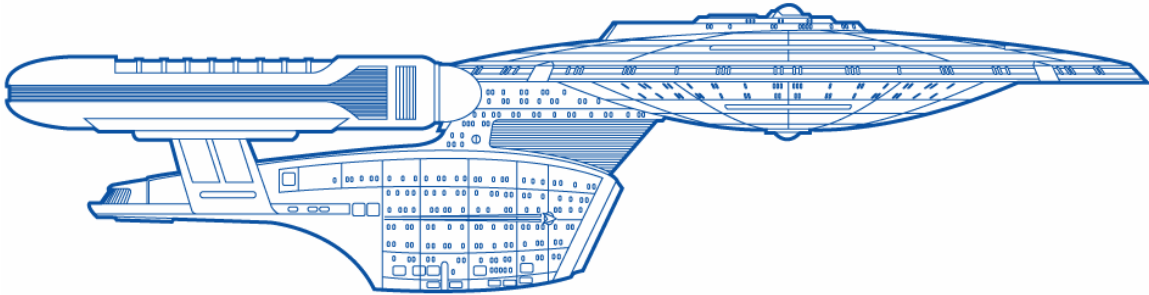

NCC-10530

U.S.S. *Highlander*

NCC-10532

U.S.S. *Horatio*

Ambassador-class

Commanded by Captain Walker Keel, the *Horatio* was destroyed near Dytallix B by an unknown alien intelligence in 2364.

NCC-10536

U.S.S. *Centaur*

Barracuda-class

NCC-10537

U.S.S. *Helios*

Barracuda-class

NCC-10542

U.S.S. *Bonaventure*

NCC-10680

U.S.S. *Perseus*

Lancelot-class

NCC-10682

U.S.S. *Livingstone*

Newton-class

NCC-10683

U.S.S. *Montgolfier*

Newton-class

NCC-10684

U.S.S. *Gagarin*

Newton-class

NCC-10701

U.S.S. *Downes*

Knox II-class

NCC-10746

U.S.S. *Richmond*

Barracuda-class

NCC-10757

U.S.S. *Ulysses*

Miranda-class

NCC-10823

U.S.S. *Montgolfier*

NCC-10890

U.S.S. *Gagarin*

NCC-10907

U.S.S. *Salt Lake City*

Barracuda-class

NCC-11000

U.S.S. *Brittania*

Brittania-class

Dreadnought, the pathfinder vessel of her class.

NCC-11027

U.S.S. *Andromeda*

Excelsior-class

NCC-11048

U.S.S. *Tiger*

Sirius-class

NCC-11075

U.S.S. *Edmund Fitzgeralds*

Freighter.

NCC-11080

U.S.S. *Alaska*

Alaska-class

First starship of her class, an assault cruiser.

NCC-11258

U.S.S. *Andes*

Barracuda-class

NCC-11259

U.S.S. *Viking*

Barracuda-class

NCC-11372

U.S.S. *Antietam*

Nebula-class

NCC-11442

U.S.S. *Jupiter*

Ambassador-class

Destroyed in 2343.

NCC-11550

U.S.S. *Apollo*

Apollo-class

Namesake and first vessel of her class.

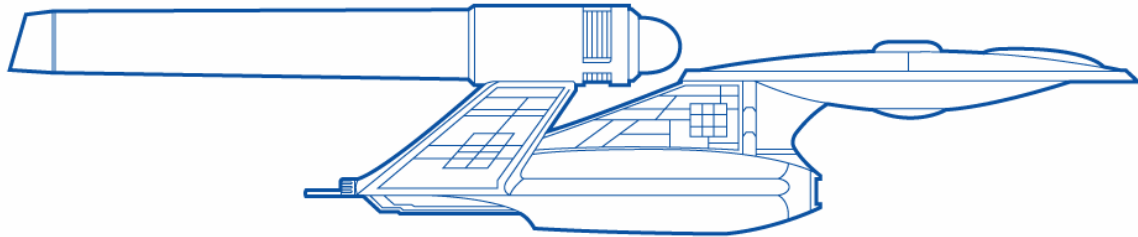

NCC-11574

U.S.S. *Ajax*

Apollo-class

The first assignment of Cortin Zwelller.

NCC-11638

U.S.S. *Agamemnon*

Apollo-class

Ship that served as a member of Task Force Three during the expected Borg invasion of 2369.

NCC-11672

U.S.S. *Gage*

Apollo-class

One of the vessels destroyed by the Borg at the 2367 Battle of Wolf 359.

NCC-11694

U.S.S. *Canterbury*

Apollo-class

NCC-11944

U.S.S. *Sun Tzu*

Apollo-class

NCC-12000

U.S.S. *Cutty Sark*

Cutty Sark-class

First vessel of her class, designated a clipper.

NCC-12537

U.S.S. *Clement*

Apollo-class

Starship assigned to core world patrol duties in the late 2360's.

NCC-12763

U.S.S. *Blackstar*

NCC-12763-A

U.S.S. *Blackstar*

NCC-12763-B

U.S.S. *Blackstar*

NCC-12763-C

U.S.S. *Blackstar*

Orion-class

NCC-13492

U.S.S. *Eagle*

NCC-13925

U.S.S. *Blackbird*

Blackbird-class

Scout ship, the first vessel of her class. Launched in 2318, the ship was armed with 5 phaser emitters and three torpedo tubes, and had a crew compliment of only 22. The ship was 104m long, 80m wide and 20m high.

NCC-13958

U.S.S. *Okinawa*

Excelsior-class

Starship commanded by the future Admiral Leyton. Benjamin Sisko served as the ship's first officer.

NCC-13995

U.S.S. *Labrador*

Blackbird-class

NCC-14028

U.S.S. *Charon*

Blackbird-class

NCC-14029

U.S.S. *Patriot*

Blackbird-class

NCC-14030

U.S.S. *Pamir*

Blackbird-class

NCC-14031

U.S.S. *Panther*

Blackbird-class

NCC-14036

U.S.S. *Hollywood*

Blackbird-class

NCC-14232

U.S.S. *Berlin*

Excelsior-class

Starship stationed near the Romulan Neutral Zone in 2364 just before the first Romulan incursion of the zone since 2311's Tomed Incident.

NCC-14270

U.S.S. *Hornet*

A fuel shuttle.

NCC-14274

U.S.S. *Tiberius*

Blackbird-class

NCC-14275

U.S.S. *Baltimore*

Blackbird-class

NCC-14276

U.S.S. *Cor Caroli*

Blackbird-class

NCC-14277

U.S.S. *Bussard*

Blackbird-class

NCC-14427	U.S.S. <i>Lexington</i>	Excelsior-class
	Vessel that transferred medical supplies to the U.S.S. <i>Enterprise</i> NCC-1701-D in 2370.	
NCC-14598	U.S.S. <i>Fearless</i>	Excelsior-class
NCC-14934	U.S.S. <i>Tecumseh</i>	Excelsior-class
	Starship if I'm ordered to counterattack Klingon forces in the Archanis Sector in 2373.	
NCC-15000	U.S.S. <i>Shrike</i>	Shrike-class
	Cargo transport/tug, first vessel of her class.	
NCC-15023	U.S.S. <i>Taif</i>	Polaris-class
NCC-15031	U.S.S. <i>Norfolk</i>	Polaris-class
NCC-15041	U.S.S. <i>Ikaria</i>	Polaris-class
NCC-15042	U.S.S. <i>Ramadan</i>	Polaris-class
NCC-15044	U.S.S. <i>Augsburg</i>	Polaris-class
NCC-15045	U.S.S. <i>Daring</i>	Polaris-class
NCC-15082	U.S.S. <i>Valour</i>	Polaris-class
NCC-15088	U.S.S. <i>Andalucia</i>	Polaris-class
NCC-15131	U.S.S. <i>Maloy</i>	Polaris-class
NCC-15134	U.S.S. <i>Haibei</i>	Polaris-class
NCC-15141	U.S.S. <i>Akagi</i>	Polaris-class
NCC-15144	U.S.S. <i>Abu Bekr</i>	Polaris-class
NCC-15168	U.S.S. <i>Mariner</i>	Surveyor-class
	Fourth starship of her class, designated an exploratory cruiser. Commanded by Captain Gregori Kamensky. It had a crew of 275, and had 12 decks. Launched from the Utopia Plantia Fleet Yards, Mars, it's dedication plaque bore the motto: " <i>There are more things in heaven and earth, than are dreamt of in your philosophy. Hamlet</i> "	
NCC-15174	U.S.S. <i>Al Siddiq</i>	Polaris-class
NCC-15191	U.S.S. <i>Sabalan</i>	Polaris-class
NCC-15199	U.S.S. <i>Al-Manama</i>	Polaris-class
NCC-15202	U.S.S. <i>Hatakaze</i>	Polaris-class
NCC-15280	U.S.S. <i>Pioneer</i>	Apollo-class
NCC-15401	U.S.S. <i>Emden</i>	Emden-class
	Escort vessel, the first of her class. Launched in 2321 after a three year construction period, the ship was 155m long, 94m wide and 34m high, with a crew of 20. A variant of the Barracuda-class.	

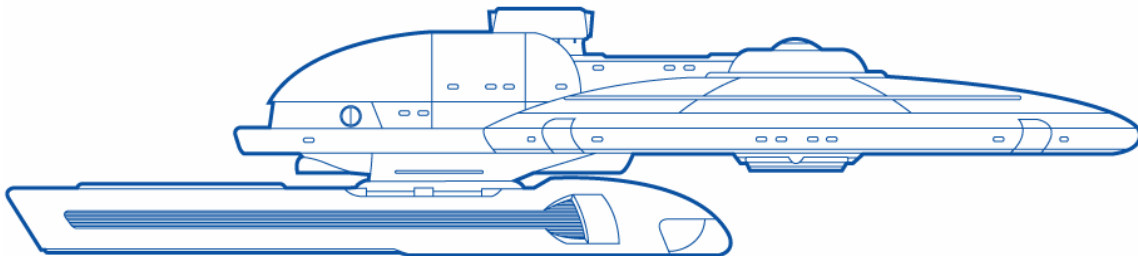

NCC-15402	U.S.S. <i>Nazca</i>	Emden-class
NCC-15403	U.S.S. <i>Baikal</i>	Emden-class
NCC-15404	U.S.S. <i>Swordfish</i>	Emden-class
NCC-15405	U.S.S. <i>Mostar</i>	Emden-class
NCC-15406	U.S.S. <i>Chronos</i>	Emden-class

NCC-15407	U.S.S. <i>Amaslon Mat</i>	Emden-class
NCC-15668	U.S.S. <i>Marathon</i>	Emden-class
NCC-15669	U.S.S. <i>Audacity</i>	Emden-class
NCC-15670	U.S.S. <i>Etendard</i>	Emden-class
NCC-15671	U.S.S. <i>Corsair</i>	Emden-class
NCC-15672	U.S.S. <i>Fury</i>	Emden-class
NCC-15673	U.S.S. <i>Baruul</i>	Emden-class
NCC-15674	U.S.S. <i>Braveheart</i>	Emden-class
NCC-15675	U.S.S. <i>Tyanak</i>	Emden-class
NCC-15739	U.S.S. <i>Chicago</i> First starship of her class.	Chicago-class
NCC-15823	U.S.S. <i>Bardeen</i>	Newton-class
NCC-15826	U.S.S. <i>Fragarach</i> Pathfinder vessel of it's class, a perimeter action vessel.	Fragarach-class
NCC-17852	U.S.S. <i>Koss</i>	Emden-class
NCC-17853	U.S.S. <i>Whirlwind</i>	Emden-class
NCC-17854	U.S.S. <i>Tannenberg</i>	Emden-class
NCC-17855	U.S.S. <i>Alizé</i>	Emden-class
NCC-17856	U.S.S. <i>Thunderstorm</i>	Emden-class
NCC-15917	U.S.S. <i>Erastis</i> Starship assigned to Starbase 324 as a medical transport vessel.	Rowan-class
NCC-16285	U.S.S. <i>Falkland</i>	Blackbird-class
NCC-16286	U.S.S. <i>Clemenceau</i>	Blackbird-class
NCC-16544	U.S.S. <i>Stockholm</i> Starship commanded by Captain Chung.	Miranda-class
NCC-17001	U.S.S. <i>Karekh</i> Pathfinder vessel of her class, an exploration vessel.	Karekh-class
NCC-17050	U.S.S. <i>Daystar</i> A heavy frigate, first of her class.	Daystar-class
NCC-17178	U.S.S. <i>Pythagoras</i>	Newton-class
NCC-17235	U.S.S. <i>Monitor</i>	Ohio-class
NCC-17236	U.S.S. <i>Merrimac</i>	
NCC-17665	U.S.S. <i>Watt</i>	Newton-class
NCC-17666	U.S.S. <i>Wernher von Braun</i>	Newton-class
NCC-17824	U.S.S. <i>Don Quixote</i>	
NCC-17925	U.S.S. <i>Cyprien</i> Starship that was destroyed by Cardassian forces.	Malachi-class
NCC-18000	U.S.S. <i>Aseroth</i> Starship, first of her class.	Aseroth-class
NCC-18223	U.S.S. <i>Hertz</i>	Newton-class
NCC-18245	U.S.S. <i>Darwin</i>	Newton-class
NCC-18253	U.S.S. <i>Potemkin</i>	Excelsior-class
NCC-18793	U.S.S. <i>Pillsbury</i>	
NCC-18800	U.S.S. <i>Oberth II</i> Pathfinder of her class, intended as a successor to the venerable Oberth class.	Oberth II-class
NCC-19002	U.S.S. <i>Yosemite</i> Starship that was severely damaged in 2369 while studying plasma streamers in the Igo Sector. Commanded by Captain Rumiell.	Oberth-class

NCC-19212	U.S.S. <i>Armstrong</i> Commanded by Captain Johnson in 2369.	Oberth-class
NCC-19350	U.S.S. <i>Hokule'a</i> First starship of her class.	Hokule'a class
NCC-19386	U.S.S. <i>Tripoli</i> Starship commanded by Captain Jon Jakob Thorsson, made famous for it's discovery of the android Data. Decommissioned, it was stolen from the surplus depot at Qualor II by Romulan operatives in 2368.	Hokule'a class
NX-19500	U.S.S. <i>Alliance</i> Pathfinder vessel of her class, a dreadnought.	Alliance-class
NCC-19794	U.S.S. <i>Sakai</i>	Hokule'a-class
NCC-19820	U.S.S. <i>Reliant</i>	Blackbird-class
NCC-20000	U.S.S. <i>Sagan</i> Science research vessel, first of it's class.	Sagan-class
NCC-20001	U.S.S. <i>Valiant</i>	Oberth-class
NCC-20002	U.S.S. <i>Tsiolkovsky</i>	Sagan-class
NCC-20003	U.S.S. <i>Carson</i>	Sagan-class
NCC-20004	U.S.S. <i>Meade</i>	Sagan-class
NCC-20005	U.S.S. <i>Einstein</i>	Sagan-class
NCC-20006	U.S.S. <i>Cochrane</i>	Sagan-class
NCC-20007	U.S.S. <i>Fermi</i>	Sagan-class
NCC-20008	U.S.S. <i>V'Ryugenn</i>	Sagan-class
NCC-20009	U.S.S. <i>Mendeleyev</i>	Sagan-class
NCC-20010	U.S.S. <i>Surishian</i>	Sagan-class
NCC-20011	U.S.S. <i>T'mirea</i>	Sagan-class
NCC-20012	U.S.S. <i>Skoatar</i>	Sagan-class
NCC-20013	U.S.S. <i>Shoonedev</i>	Sagan-class
NCC-20014	U.S.S. <i>Lowell</i>	Sagan-class
NCC-20015	U.S.S. <i>Daystrom</i>	Sagan-class
NCC-20016	U.S.S. <i>Crater</i>	Sagan-class
NCC-20017	U.S.S. <i>Corby</i>	Sagan-class
NCC-20027	U.S.S. <i>Tetherin</i> Exploratory cruiser, first of her class.	Tetherin-class
NCC-20098	U.S.S. <i>Glenn</i>	Meteor-class
NCC-20100	U.S.S. <i>Derf</i> First vessel of her class, a repair tender.	Derf-class
NCC-20105	U.S.S. <i>Nash</i>	Sydney-class
NCC-20273	U.S.S. <i>Lindenbergh</i>	Blackbird-class
NCC-20300	U.S.S. <i>Wambundu</i> Starship, first of her class.	Wambundu-class
NCC-20316	U.S.S. <i>Fleming</i> Medical transport vessel lost in the Hekaras corridor in 2370, though it's crew was saved.	Wambundu-class
NCC-20381	U.S.S. <i>Drake</i> Starship destroyed by an ancient weapons system at planet Minos in 2364. At the time the ship was commanded by Captain Paul Rice.	Wambundu-class
NX-20500	U.S.S. <i>Chicago II</i> First starship of her class.	Chicago II-class

NCC-21004	U.S.S. <i>Java</i>	Java-class	Cargo vessel, the first ship of her class. At 568m long, the ship can carry as many as 24 cargo containers with a total volume of 1.44 million cubic meters. The ship was 142m wide and 99m high, with a crew of 30. Launched in 2320.
NCC-21005	U.S.S. <i>Holberg</i>	Java-class	
NCC-21006	U.S.S. <i>Valdez</i>	Java-class	
NCC-21007	U.S.S. <i>Scapa Flow</i>	Java-class	
NCC-21008	U.S.S. <i>Merchantman</i>	Java-class	
NCC-21009	U.S.S. <i>Flying Dutchman</i>	Java-class	
NCC-21050	U.S.S. <i>Nineveh</i>	Nineveh-class	First starship of her class, a large exploratory cruiser.
NCC-21166	U.S.S. <i>Brittain</i>	Miranda-class	Starship trapped in a Tyken's Rift in 2367, all but one of it's crew murdered each other, including Captain Chantal Zaneva. Built at the 40 Eridani-A Starfleet Construction Yards and commissioned stardate 22519.5. The ship's motto was "a three hour tour, a three hour tour..."
NCC-21382	U.S.S. <i>Tian an Men</i>	Miranda-class	This ship served in Captain Jean-Luc Picard's armada to blockade the Romulan supply ships that were supplying the Duras family during the Klingon civil war of 2367-68. The ship was presumed destroyed by Dominion forces around stardate 50929.
NCC-21507	U.S.S. <i>Planck</i>	Newton-class	
NCC-21508	U.S.S. <i>Sakharov</i>	Newton-class	
NCC-21509	U.S.S. <i>Copernicus</i>	Newton-class	
NCC-21510	U.S.S. <i>Lilienthal</i>	Newton-class	
NCC-21760	U.S.S. <i>Colin Powell</i>	Colin Powell-class	Long range warp shuttle, the first one of her class.
NX-21800	U.S.S. <i>Turbidus</i>	Turbidus-class	Prototype destroyer.
NCC-22012	U.S.S. <i>Defender</i>	Defender-class	First vessel of her class, a destroyer.
NCC-22059	U.S.S. <i>Verrazano</i>	Ericsson-class	An exploratory cruiser.
NCC-22821	U.S.S. <i>Leeds</i>	Nebula-class	
NCC-22876	U.S.S. <i>Agulhas</i>	Java-class	
NCC-22877	U.S.S. <i>Navidad</i>	Java-class	
NCC-22878	U.S.S. <i>Fugger</i>	Java-class	
NCC-23005	U.S.S. <i>Lng'we Chi</i>	Lng'we Chi-class	Prototype vessel, an exploratory cruiser.
NCC-23018	U.S.S. <i>Prowler</i>	Prowler-class	Interceptor, first vessel of her class.
NCC-23102	U.S.S. <i>Marko Ramius</i>		
NCC-23106	U.S.S. <i>Mark Twain</i>		
NCC-20110	U.S.S. <i>Battlestar</i>		
NCC-23612	U.S.S. <i>Madison</i>	Ambassador-class	
NCC-24002	U.S.S. <i>Vanguard</i>	Vanguard-class	First ship of her class, a destroyer.
NCC-24295	U.S.S. <i>Sakharov</i>		
NCC-24301	U.S.S. <i>K'Kmarak</i>	K'Kmarak-class	Prototype starship of her class, a research/survey vessel.

NCC-24509	U.S.S. <i>Valley Forge</i> A strike cruiser.	Monarch-class
NCC-24572	U.S.S. <i>Ogun</i>	Wambundu-class
NCC-24705	U.S.S. <i>Cantabrian</i>	Quasar-class
NCC-24851	U.S.S. <i>Valkyrie</i> Prototype vessel of her class, a corvette.	Valkyrie-class
NCC-24870	U.S.S. <i>Copernicus City</i>	Java-class
NCC-24871	U.S.S. <i>Manark</i>	Java-class
NCC-24872	U.S.S. <i>Regulus</i>	Java-class
NCC-24873	U.S.S. <i>Aaron Satie</i>	Java-class
NCC-24874	U.S.S. <i>Gobi</i>	Java-class
NCC-24875	U.S.S. <i>Gauteng</i>	Java-class
NCC-24876	U.S.S. <i>Tyree</i>	Java-class
NCC-24877	U.S.S. <i>Delos</i>	Java-class
NCC-24878	U.S.S. <i>Lagana</i>	Java-class
NCC-24879	U.S.S. <i>Antwerpen</i>	Java-class
NCC-24880	U.S.S. <i>Melnos</i>	Java-class
NCC-24881	U.S.S. <i>Potomac</i>	Java-class
NCC-24882	U.S.S. <i>Lobi</i>	Java-class
NCC-24981	U.S.S. <i>Thames</i>	Excelsior-class
NCC-25119	U.S.S. <i>Andor</i> Transport vessel, launched in 2322, with a crew of 36. The first vessel of her class, the ship was 135m long, 120m wide and 22m high.	Andor-class
NCC-25120	U.S.S. <i>Nomad</i>	Andor-class
NCC-25121	U.S.S. <i>Hudson Bay</i>	Andor-class
NCC-25122	U.S.S. <i>Capetown</i>	Andor-class
NCC-25134	U.S.S. <i>Oxford</i>	Andor-class
NCC-25227	U.S.S. <i>Flare</i>	Emden-class
NCC-25228	U.S.S. <i>Satalik</i>	Emden-class
NCC-25229	U.S.S. <i>Harpoon</i>	Emden-class
NCC-25230	U.S.S. <i>Namsla</i>	Emden-class
NCC-25231	U.S.S. <i>North Star</i>	Emden-class
NCC-25232	U.S.S. <i>Punjab</i>	Emden-class
NCC-26136	U.S.S. <i>Zhukov</i> Starship commanded by Captain Gleason, it was a former posting of Reginald Barclay.	Ambassador-class
NCC-26198	U.S.S. <i>Valdemar</i> Starship dispatched to the Cardassian DMZ in 2370.	Ambassador-class
NCC-26220	U.S.S. <i>Kepler</i>	Andor-class
NCC-26226	U.S.S. <i>Formidable</i>	Reliant-class
NCC-26227	U.S.S. <i>Defender</i>	Reliant-class
NCC-26228	U.S.S. <i>Triumph</i>	Reliant-class
NCC-26229	U.S.S. <i>Vengeance</i>	Reliant-class
NCC-26230	U.S.S. <i>Venerable</i>	Reliant-class
NCC-26231	U.S.S. <i>Ardent</i>	Reliant-class
NCC-26232	U.S.S. <i>Encounter</i>	Reliant-class
NCC-26233	U.S.S. <i>Champion</i>	Reliant-class
NCC-26234	U.S.S. <i>Furious</i>	Reliant-class

NCC-26235	U.S.S. <i>Ramilles</i>	Reliant-class
NCC-26236	U.S.S. <i>Conqueror</i>	Reliant-class
NCC-26237	U.S.S. <i>Glorious</i>	Reliant-class
NCC-26238	U.S.S. <i>Terror</i>	Reliant-class
NCC-26239	U.S.S. <i>Valorous</i>	Reliant-class
NCC-26240	U.S.S. <i>Terminator</i>	Reliant-class
NCC-26241	U.S.S. <i>Courageous</i>	Reliant-class
NCC-26242	U.S.S. <i>Vindicator</i>	Reliant-class
NCC-26243	U.S.S. <i>Redoubt</i>	Reliant-class
NCC-26244	U.S.S. <i>Guardian</i>	Reliant-class
NCC-26245	U.S.S. <i>Regulator</i>	Reliant-class
NCC-26246	U.S.S. <i>Invicta</i>	Reliant-class
NCC-26247	U.S.S. <i>Kings Destroyer</i>	Reliant-class
NCC-26248	U.S.S. <i>Audacious</i>	Reliant-class
NCC-26249	U.S.S. <i>Daredevil</i>	Reliant-class
NCC-26250	U.S.S. <i>Striker</i>	Reliant-class
NCC-26251	U.S.S. <i>Enforcer</i>	Reliant-class
NCC-26252	U.S.S. <i>Rigorous</i>	Reliant-class
NCC-26253	U.S.S. <i>Blade of Tellar</i>	Reliant-class
NCC-26254	U.S.S. <i>Immortal</i>	Reliant-class
NCC-26255	U.S.S. <i>Commencement</i>	Reliant-class
NCC-26256	U.S.S. <i>Accommodator</i>	Reliant-class
NCC-26257	U.S.S. <i>Dominator</i>	Reliant-class
NCC-26258	U.S.S. <i>Lifeforce</i>	Reliant-class
NCC-26259	U.S.S. <i>Eradicator</i>	Reliant-class
NCC-26260	U.S.S. <i>Warrior</i>	Reliant-class
NCC-26261	U.S.S. <i>Pugilist</i>	Reliant-class
NCC-26262	U.S.S. <i>Archer</i>	Reliant-class
NCC-26263	U.S.S. <i>Grenadier</i>	Reliant-class
NCC-26264	U.S.S. <i>Fusilier</i>	Reliant-class
NCC-26265	U.S.S. <i>Reforger</i>	Reliant-class
NCC-26266	U.S.S. <i>Brave Shield</i>	Reliant-class
NCC-26267	U.S.S. <i>Legionaire</i>	Reliant-class
NCC-26268	U.S.S. <i>Administrator</i>	Reliant-class
NCC-26269	U.S.S. <i>Valhalla</i>	Reliant-class
NCC-26270	U.S.S. <i>Forceful</i>	Reliant-class
NCC-26271	U.S.S. <i>Redan</i>	Reliant-class
NCC-26272	U.S.S. <i>Perseus</i>	Reliant-class
NCC-26273	U.S.S. <i>Thetis</i>	Reliant-class
NCC-26274	U.S.S. <i>Crommalen</i>	Reliant-class
NCC-26275	U.S.S. <i>Amador</i>	Reliant-class
NCC-26276	U.S.S. <i>Circe</i>	Reliant-class
NCC-26277	U.S.S. <i>Achilles</i>	Reliant-class
NCC-26278	U.S.S. <i>Odysseus</i>	Reliant-class
NCC-26279	U.S.S. <i>Ra</i>	Reliant-class
NCC-26280	U.S.S. <i>Odessa</i>	Reliant-class

NCC-26281	U.S.S. <i>Thurgon</i>	Reliant-class
NCC-26282	U.S.S. <i>Athena</i>	Reliant-class
NCC-26283	U.S.S. <i>Hypnos</i>	Reliant-class
NCC-26284	U.S.S. <i>Vesta</i>	Reliant-class
NCC-26285	U.S.S. <i>Hermes</i>	Reliant-class
NCC-26286	U.S.S. <i>Artemis</i>	Reliant-class
NCC-26287	U.S.S. <i>Minerva</i>	Reliant-class
NCC-26288	U.S.S. <i>Bacchus</i>	Reliant-class
NCC-26289	U.S.S. <i>Dionysus</i>	Reliant-class
NCC-26290	U.S.S. <i>Ceres</i>	Reliant-class
NCC-26291	U.S.S. <i>Ares</i>	Reliant-class
NCC-26292	U.S.S. <i>Hestia</i>	Reliant-class
NCC-26293	U.S.S. <i>Asclepius</i>	Reliant-class
NCC-26294	U.S.S. <i>Hephaestus</i>	Reliant-class
NCC-26295	U.S.S. <i>Demeter</i>	Reliant-class
NCC-26296	U.S.S. <i>Poseidon</i>	Reliant-class
NCC-26297	U.S.S. <i>Hera</i>	Reliant-class
NCC-26298	U.S.S. <i>Chronos</i>	Reliant-class
NCC-26299	U.S.S. <i>Hathor</i>	Reliant-class
NCC-26300	U.S.S. <i>Isis</i>	Reliant-class
NCC-26301	U.S.S. <i>Osiris</i>	Reliant-class
NCC-26302	U.S.S. <i>Thoth</i>	Reliant-class
NCC-26351	U.S.S. <i>Hispaniola</i>	Andor-class
NCC-26510	U.S.S. <i>Yamagouchi</i>	Ambassador-class
	One of the 39 Federation starships destroyed at the 2367 battle with the Borg at Wolf 359.	
NCC-26517	U.S.S. <i>Excalibur</i>	Ambassador-class
	The <i>Excalibur</i> was originally commanded by Captain Korsmo. Heavily damaged in the 2373 Borg offensive on Earth, the ship underwent an extensive refit. Command was given to Captain Mackenzie Colhoun. The ship had a crew of only 603. The ship was later destroyed.	
NCC-26517-A	U.S.S. <i>Excalibur</i>	Galaxy-class
	Commanded by Captain Mackenzie Colhoun, it was a replacement for the Ambassador-class vessel. Commissioned in 2376.	
NCC-26531	U.S.S. <i>Exeter</i>	Ambassador-class
	Former posting of Thomas E. Paris, in 2374 it was part of the Ninth Fleet, headquartered at Deep Space Nice.	
NCC-26632	U.S.S. <i>Gandhi</i>	Ambassador-class
	Former posting of Thomas Riker, he left the ship in 2371.	
NCC-26741	U.S.S. <i>Zuerich</i>	Blackbird-class
NCC-26742	U.S.S. <i>Hubble</i>	Blackbird-class
NCC-26743	U.S.S. <i>Urga</i>	Blackbird-class
NCC-26840	U.S.S. <i>Heinbuch</i>	
NCC-26849	U.S.S. <i>Adelphi</i>	Ambassador-class
	Starship renown for making disastrous first contact with planet Ghorusda. 47 people, including commanding officer Captain Darson, were killed.	
NCC-26850	U.S.S. <i>Oday</i>	Constellation-class
NCC-26958	U.S.S. <i>Aldebaran</i>	Andor-class
NCC-26959	U.S.S. <i>North Sea</i>	Andor-class

NCC-27300	U.S.S. <i>MacPherson</i>	MacPherson-class First starship of her class, a heavy transport.
NCC-27301	U.S.S. <i>Hunter</i>	MacPherson-class
NCC-27302	U.S.S. <i>Ireland</i>	
NCC-27303	U.S.S. <i>Williams</i>	MacPherson-class
NCC-27304	U.S.S. <i>Crawford</i>	MacPherson-class
NCC-27305	U.S.S. <i>Richardson</i>	MacPherson-class
NCC-27306	U.S.S. <i>Montana</i>	MacPherson-class
NCC-27307	U.S.S. <i>Porizkova</i>	MacPherson-class
NCC-27308	U.S.S. <i>Seymour</i>	MacPherson-class
NCC-27309	U.S.S. <i>Everhart</i>	MacPherson-class
NCC-27310	U.S.S. <i>Taylor</i>	MacPherson-class
NCC-27562	U.S.S. <i>Namib</i>	Andor-class
NCC-27943	U.S.S. <i>V'torrekh</i>	Wambundu-class
NX-28382	U.S.S. <i>Niagara</i>	Niagara-class Starship, the first vessel of her class, a tri-nacelled design.

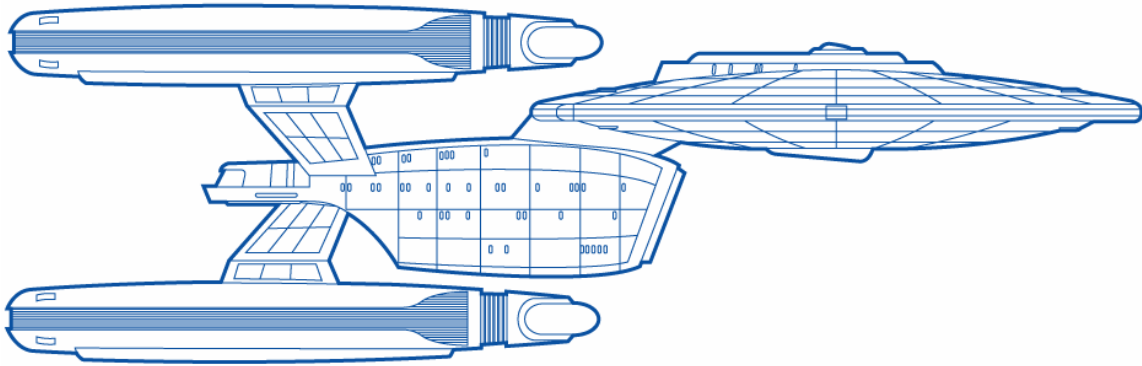

NCC-28470	U.S.S. <i>Nineveh</i>	Nineveh-class Starship, first of her class, a battle cruiser.
NCC-28473	U.S.S. <i>Wellington</i>	Niagara-class Fast cruiser with a crew of 400, it was a former posting of Ro Laren. The ship received a computer upgrade by Bynar technicians at Starbase 74 in 2364.
NCC-29114	U.S.S. <i>Kabul</i>	Andor-class
NCC-29136	U.S.S. <i>Antares</i>	Andor-class
NCC-29231	U.S.S. <i>Urga</i>	
NCC-29402	U.S.S. <i>Jefferson Randolph Smith</i>	Sulek-class Mineral prospecting vessel commanded by Captain Tatyana Trofimov, it was destroyed in orbit of planet Direidi.
NCC-29487	U.S.S. <i>Ramon</i>	A science vessel.
NCC-30055	U.S.S. <i>Fury</i>	Fury-class A prototype small frigate, first vessel of her class.
NCC-30889	U.S.S. <i>Dauntless</i>	
NCC-31347	U.S.S. <i>Trident</i>	Starship commanded by Captain Elizabeth Shelby.
NCC-31600	U.S.S. <i>Bonestell</i>	Oberth-class Starship lost to the Borg in the 2367 battle of Wolf 359.
NCC-31649	U.S.S. <i>Doyle</i>	Wambundu-class

NCC-31660	U.S.S. <i>Majestic</i>	Miranda-class	Starship lost during the intense battle of 2374 to take back station Deep Space Nine from Dominion control.
NCC-31905	U.S.S. <i>ShirKahr</i>	Miranda-class	Part of a combined Alpha Quadrant fleet that invaded the Chin'toka system in late 2374. The ship was destroyed.
NCC-31910	U.S.S. <i>Nautilus</i>	Miranda-class	Part of a combined Alpha Quadrant fleet that invaded the Chin'toka system in late 2374.
NCC-31911	U.S.S. <i>Saratoga</i>	Miranda-class	One of many vessels to bear the name, Benjamin Sisko was the ship's first officer when the vessel was lost at the Battle of Wolf 359 in 2367.
NCC-31911-A	U.S.S. <i>Saratoga</i>	Miranda-class	Vessel name and registered to honor the <i>Saratoga</i> lost at the 2367 Battle of Wolf 359.
NCC-32345	U.S.S. <i>Hoagland</i>	Miranda-class	
NCC-32666	U.S.S. <i>Jaguar</i>	Andor-class	
NCC-32693	U.S.S. <i>Mandela</i>	Andor-class	
NCC-32759	U.S.S. <i>Chengdai</i>	Apollo-class	Starship that served as a troop transport during the Cardassian conflict of 2356-67.
NCC-33184	U.S.S. <i>Zapata</i>	Surak-class	
NCC-33652	U.S.S. <i>Chaco</i>	Andor-class	
NCC-33894	U.S.S. <i>Vigilant</i>	Miranda-class	Starship lost in 2348 during long-range survey mission in the Perseus Arm.
NCC-34000	U.S.S. <i>Istanbul</i>	Istanbul-class	Pathfinder vessel, the first of her class.
NCC-34043	U.S.S. <i>Havana</i>	Istanbul-class	
NCC-34055	U.S.S. <i>Chicago</i>	Istanbul-class	
NCC-34081	U.S.S. <i>Koenigsburg</i>	Andor-class	
NCC-34099	U.S.S. <i>Livingston</i>	Excelsior-class	Former posting of both Benjamin Sisko and Curzon Dax.
NCC-34114	U.S.S. <i>Persephone</i>	Andor-class	
NCC-34123	U.S.S. <i>Kiev</i>	Isatabul-class	
NCC-34852	U.S.S. <i>Constantinople</i>	Istanbul-class	Cruiser that suffered a hull breach near Gravesworld while carrying 2012 colonists in 2365. The ship's crew was rescued by the <i>starship Enterprise</i> NCC-1701-D.
NCC-35015	U.S.S. <i>Nottingham</i>	Emden-class	
NCC-35016	U.S.S. <i>Aram Bayaani</i>	Emden-class	
NCC-35017	U.S.S. <i>Freya</i>	Emden-class	
NCC-35018	U.S.S. <i>Jaffa</i>	Emden-class	
NCC-35019	U.S.S. <i>Karam</i>	Emden-class	
NCC-35020	U.S.S. <i>Montgomery</i>	Emden-class	
NCC-35021	U.S.S. <i>Velociraptor</i>	Emden-class	
NCC-35022	U.S.S. <i>Aral</i>	Emden-class	
NCC-35337	U.S.S. <i>Wright</i>	Newton-class	
NCC-35338	U.S.S. <i>Stevenson</i>	Newton-class	
NCC-35339	U.S.S. <i>Bell</i>	Newton-class	

NCC-35892	U.S.S. <i>Gah'tal</i>	Surak-class
NCC-37124	U.S.S. <i>Trieste</i>	Merced-class
	Light escort with a crew of 50. Data served aboard this vessel, during which time the ship encountered a wormhole.	
NCC-37912	U.S.S. <i>Perseus</i>	Medusa-class
	A fast destroyer.	
NCC-38154	U.S.S. <i>Araba</i>	Irtysh-class
	A research cruiser.	
NCC-38517	U.S.S. <i>Venus</i>	Venus-class
	Light cruiser, the first vessel of her class. Launched in 2330, the ship was 420m long, 227m wide and 91m high, and had a crew compliment of 265.	
NCC-38529	U.S.S. <i>Sarajevo</i>	Istanbul-class
	Fast cruiser, lost in the Gamma Quadrant prior to 2371. Believed lost to Dominion forces.	
NCC-38762	U.S.S. <i>Agincourt</i>	Excelsior-class
NCC-38907	U.S.S. <i>Intrepid</i>	Excelsior-class
	Starship that responded to the distress call from the Khitomer outpost when it was attacked by Romulans in 2346. Under the command of Captain Drew Deighan at that time (stardate 23859.7), Chief Petty Officer Sergey Rozhenko also served aboard her.	
NCC-38955	U.S.S. <i>Crockett</i>	Excelsior-class
NCC-38997	U.S.S. <i>Malinche</i>	Excelsior-class
	Starship patrolling the Cardassian DMZ on stardate 50485.2 under the command of Captain Sanders, it was disabled by a group of Maquis raiders.	
NCC-39217	U.S.S. <i>Wells</i>	Niagra-class
NCC-39412	U.S.S. <i>Centaur</i>	Centaur-class
	First starship of her class, it was commanded by Captain Charles Reynolds.	
NCC-39483	U.S.S. <i>Huru</i>	Centaur-class
NCC-39639	U.S.S. <i>Cumbria</i>	Andor-class
NCC-39642	U.S.S. <i>Luxor</i>	Andor-class
NCC-39643	U.S.S. <i>Fairfax</i>	Niagra-class
NCC-39822	U.S.S. <i>Zuse</i>	Centaur-class
	Starship lost and presumed destroyed.	
NCC-40172	U.S.S. <i>Butterfly</i>	Andor-class
NCC-40213	U.S.S. <i>Gala</i>	Centaur-class
	Starship destroyed by a warp-core breach.	
NCC-40365	U.S.S. <i>Amsterdam</i>	Geneva-class
NCC-40512	U.S.S. <i>Gorkon</i>	Excelsior-class
	Flagship of Admiral Nechev during the expected Borg invasion of 2369.	
NCC-40884	U.S.S. <i>Mars</i>	Venus-class
NCC-40927	U.S.S. <i>Jupiter</i>	Venus-class
NCC-40930	U.S.S. <i>Rigel</i>	Venus-class
NCC-41006	U.S.S. <i>Varna</i>	Andor-class
NCC-41187	U.S.S. <i>Tranquility</i>	
NCC-41253	U.S.S. <i>Deneb</i>	Venus-class
NCC-41452	U.S.S. <i>Independence</i>	Sparta-class
NCC-41564	U.S.S. <i>Curie</i>	
NCC-41786	U.S.S. <i>Tenochtitlan</i>	Tenochtitlan-class
	Research vessel, the first ship of her class. Launched in 2333, the ship was 315m long, 227m wide and 87m high. The ship had a crew complement of 116.	

NCC-41787	U.S.S. <i>Zimbabwe</i>	Tenochititlan-class
NCC-41817	U.S.S. <i>Sumpter</i>	Sumpter-class
	Namesake vessel of the class, a heavy destroyer.	
NCC-41865	U.S.S. <i>Cestus</i>	Andor-class
NCC-42111	U.S.S. <i>Fredrickson</i>	Excelsior-class
	One of several ships damaged in battle with the Dominion in early 2374.	
NCC-42136	U.S.S. <i>Cairo</i>	Excelsior-class
	Former command of Captain Edward Jellico. The ship was lost and presumed destroyed in 2374 by Dominion forces while on patrol near the Romulan Neutral Zone.	
NCC-42173	U.S.S. <i>Kongo</i>	Excelsior-class
NCC-42284	U.S.S. <i>Raging Queen</i>	
	Starship, a through deck carrier.	
NCC-42285	U.S.S. <i>Charleston</i>	Excelsior-class
NCC-42296	U.S.S. <i>Hood</i>	Excelsior-class
	Commanded by Captain Robert DeSoto, the former postings of William T. Riker and Geordi LaForge. Part of a combined fleet that invaded the Chin'toka system in late 2374.	
NCC-42451	U.S.S. <i>Righteous</i>	Excelsior-class
NCC-42530	U.S.S. <i>Tanganika</i>	Tanganyika-Class
	Light cruiser, the first vessel of her class. Launched in 2234, the ship had two shuttle bays and a shuttle compliment of 23. The ship was 371m long, 199m wide and 79m high. The crew compliment was 386.	
NCC-42768	U.S.S. <i>Lakota</i>	Excelsior-class
	Starship commanded by Captain Erika Benteen, the ship had upgraded weaponry systems.	
NCC-42857	U.S.S. <i>Grissom</i>	Excelsior-class
NCC-42963	U.S.S. <i>Navajo</i>	Procyon-class
NCC-42995	U.S.S. <i>Al Batani</i>	Excelsior-class
	Former posting of Kathryn Janeway, the ship was under command of future-Admiral Owen Paris at the time.	
NCC-43256	U.S.S. <i>Vancouver</i>	Vancouver-class
	A cruiser, first of her class.	
NCC-43261	U.S.S. <i>Idaho</i>	Excelsior-class
NCC-43305	U.S.S. <i>Valley Forge</i>	Excelsior-class
	Part of a combined Alpha-Quadrant fleet that invaded the Chin'toka system in late 2374.	
NCC-43730	U.S.S. <i>Wyoming</i>	Mediterranean-class
	Tuvok served aboard this vessel in 2349 after returning to Starfleet following an absence of 51 years.	
NCC-43837	U.S.S. <i>Lalo</i>	Mediterranean-class
	One of the very first starships lost to the Borg, it was destroyed near Zeta Alpha II in 2366.	
NCC-44000	U.S.S. <i>Starfighter</i>	Starfighter-class
	Dreadnought, first of her class.	
NCC-44121	U.S.S. <i>Taiga</i>	Emden-class
NCC-44122	U.S.S. <i>Harbin</i>	Emden-class
NCC-44123	U.S.S. <i>Porthos</i>	Emden-class
NCC-44124	U.S.S. <i>Nayak</i>	Emden-class
NCC-44278	U.S.S. <i>Archer</i>	
	Part of Battle Group Omega.	

NCC-44454	U.S.S. <i>Aegean</i>	Mediterranean-class
NCC-45109	U.S.S. <i>Maryland</i>	Renaissance-class
	Ship lost in the Gamma Quadrant prior to 2371, later believed to be lost to Dominion forces.	
NCC-45167	U.S.S. <i>Aries</i>	Renaissance-class
	Last assignment of former U.S.S. <i>Victory</i> crewmember Mendez before her disappearance in 2367. William Riker had turned down an offer to command the <i>Aries</i> in 2365.	
NCC-45221	U.S.S. <i>Essex</i>	
NCC-45231	U.S.S. <i>Hornet</i>	Renaissance-class
	Ship that served in Captain Jean-Luc Picard's armada to blockade the Romulan supply ships supporting the Duras family during the Klingon civil war of 2367-68.	
NCC-45238	U.S.S. <i>Hokkaido</i>	Renaissance-class
NCC-45391	U.S.S. <i>Los Angeles</i>	Tanganyika-Class
NCC-45392	U.S.S. <i>Bravery</i>	Tanganyika-Class
NCC-45393	U.S.S. <i>Hispaniola</i>	Tanganyika-Class
NCC-45617	U.S.S. <i>Curry</i>	Shelley-class
NCC-45618	U.S.S. <i>Drexler</i>	Shelley-class
	Starship lost in the 2374 Battle of Tyra.	
NCC-45619	U.S.S. <i>Sternbach</i>	Shelley-class
NCC-46151	U.S.S. <i>Tel Aviv</i>	Stockholm-class
NCC-46192	U.S.S. <i>Troy</i>	Tenochtitlan-class
NCC-46612	U.S.S. <i>Fascenelli</i>	Renaissance-class
NCC-46735	U.S.S. <i>Schiavona</i>	Renaissance-class
NCC-46920	U.S.S. <i>Vladivostok</i>	Vladivostok-class
	Freighter, the first starship of her class. Launched in 2338, the ship was 154m long, 75m wide and 34m high. It had a crew compliment of 34.	
NCC-46921	U.S.S. <i>Zanzibar</i>	Vladivostok-class
NCC-46948	U.S.S. <i>Saigon</i>	Vladivostok-class
NCC-46949	U.S.S. <i>Tel Aviv</i>	Vladivostok-class
NCC-46950	U.S.S. <i>Nassau</i>	Vladivostok-class
NCC-46951	U.S.S. <i>Vilnius</i>	Vladivostok-class
NCC-46952	U.S.S. <i>Belem</i>	Vladivostok-class
NCC-46955	U.S.S. <i>Bristol</i>	Vladivostok-class
NCC-46956	U.S.S. <i>Granada</i>	Vladivostok-class
NCC-47096	U.S.S. <i>Taimyr</i>	Vladivostok-class
NCC-47097	U.S.S. <i>Tianjin</i>	Vladivostok-class
NCC-47098	U.S.S. <i>Narvik</i>	Vladivostok-class
NCC-47459	U.S.S. <i>Karachi</i>	Vladivostok-class
NCC-47460	U.S.S. <i>Kingston</i>	Vladivostok-class
NCC-47461	U.S.S. <i>Ladoga</i>	Vladivostok-class
NCC-47462	U.S.S. <i>Belfast</i>	Vladivostok-class
NCC-47463	U.S.S. <i>Rocky Mountains</i>	Vladivostok-class
NCC-47464	U.S.S. <i>New Guinea</i>	Vladivostok-class
NCC-47521	U.S.S. <i>Carthage</i>	Tenochtitlan-class
NCC-48201	U.S.S. <i>Splendor</i>	Splendor-class
	Destroyer, the first vessel of her class. Launched in 2339, the ship had a crew of 190 personnel. The ship was 340m long, 219m wide and 59m high. During the	

ship's testing, 14 crewmembers were killed during a disastrous impulse reactor breach, which led to some system redesigns.

NCC-48202	U.S.S. <i>Tsunami</i>	Splendor-class
NCC-48203	U.S.S. <i>Mir</i>	Splendor-class
NCC-48204	U.S.S. <i>Alliance</i>	Splendor-class
NCC-48395	U.S.S. <i>La Paz</i>	Vladivostok-class
NCC-48396	U.S.S. <i>Atacama</i>	Vladivostok-class
NCC-48729	U.S.S. <i>Prosperity</i>	Tanganyika-Class
NCC-48730	U.S.S. <i>Cutty Sark</i>	Tanganyika-Class
NCC-48731	U.S.S. <i>Anatolia</i>	Tanganyika-Class
NCC-48732	U.S.S. <i>Zenith</i>	Tanganyika-Class
NCC-48733	U.S.S. <i>Krakow</i>	Tanganyika-Class
NCC-48734	U.S.S. <i>Shark</i>	Tanganyika-Class
NCC-49004	U.S.S. <i>Samoa</i>	Vladivostok-class
NCC-49005	U.S.S. <i>Auckland</i>	Vladivostok-class
NCC-49006	U.S.S. <i>Alberta</i>	Vladivostok-class
NCC-49007	U.S.S. <i>Nevada</i>	Vladivostok-class
NCC-50000	U.S.S. <i>Wellington</i>	Wellington-class
	Light cruiser, prototype vessel of her class.	
NCC-50001	U.S.S. <i>Blucher</i>	Wellington-class
NCC-50002	U.S.S. <i>Napoleon</i>	Wellington-class
NCC-50003	U.S.S. <i>Colloredo</i>	Wellington-class
NCC-50004	U.S.S. <i>Cordoba</i>	Wellington-class
NCC-50005	U.S.S. <i>Bellisarius</i>	Wellington-class
NCC-50006	U.S.S. <i>Garth</i>	Wellington-class
NCC-50007	U.S.S. <i>Rommel</i>	Wellington-class
NCC-50008	U.S.S. <i>Mordaecai</i>	Wellington-class
NCC-50009	U.S.S. <i>Montgomery</i>	Wellington-class
NCC-50010	U.S.S. <i>Adolphus</i>	Wellington-class
NCC-50011	U.S.S. <i>Tilly</i>	Wellington-class
NCC-50012	U.S.S. <i>Marlborough</i>	Wellington-class
NCC-50013	U.S.S. <i>Caesaria</i>	Wellington-class
	Destroyed in 2362.	
NCC-50014	U.S.S. <i>Trojan</i>	Wellington-class
NCC-50015	U.S.S. <i>Wallenstein</i>	Wellington-class
NCC-50016	U.S.S. <i>Saxe</i>	Wellington-class
NCC-50017	U.S.S. <i>R'dannan</i>	Wellington-class
NCC-50018	U.S.S. <i>Lur'Shann</i>	Wellington-class
NCC-50019	U.S.S. <i>Davout</i>	Wellington-class
NCC-50020	U.S.S. <i>Murat</i>	Wellington-class
NCC-50021	U.S.S. <i>Nathaniel Green</i>	Wellington-class
NCC-50022	U.S.S. <i>Uxbridge</i>	Wellington-class
NCC-50023	U.S.S. <i>Ney</i>	Wellington-class
NCC-50024	U.S.S. <i>Nelson</i>	Wellington-class
NCC-50025	U.S.S. <i>Carver</i>	Wellington-class
NCC-50026	U.S.S. <i>Drake</i>	Wellington-class
NCC-50027	U.S.S. <i>Apollinari</i>	Wellington-class

NCC-50028	U.S.S. <i>Hawkins</i>	Wellington-class
NCC-50029	U.S.S. <i>Bagration</i>	Wellington-class
NCC-50030	U.S.S. <i>Barclay d'Tolly</i>	Wellington-class
NCC-50031	U.S.S. <i>Manstein</i>	Wellington-class
NCC-50032	U.S.S. <i>Patton II</i>	Wellington-class
NCC-50132	U.S.S. <i>Zenith</i>	
NCC-50331	U.S.S. <i>Biko</i>	Olympic-class
	Starship scheduled to rendezvous with the U.S.S. <i>Enterprise</i> NCC-1701-D on stardate 46721 at planet Deinoychus.	
NCC-50332	U.S.S. <i>Persepolis</i>	Tenochtitlan-class
NCC-50348	U.S.S. <i>Helsinki</i>	
NCC-50446	U.S.S. <i>Crazy Horse</i>	Excelsior-class
	Starship that was part of Task Force Three during the expected Borg incursion of 2369.	
NCC-50567	U.S.S. <i>Hanseatic</i>	Hanseatic-class
	Starship, the first vessel of her class. A transport/tug, the ship was launched in 2347 with a crew of 88. The ship was 341m long, 146m wide and 66m high.	
NCC-50650	U.S.S. <i>Leipzig</i>	Tanganyika-Class
NCC-50651	U.S.S. <i>Navajo</i>	Tanganyika-Class
NCC-51133	U.S.S. <i>Saulf</i>	Excelsior-class
NCC-51378	U.S.S. <i>Raleigh</i>	Niagra-class
	Starship that was the location of negotiations which established the Rigellian Trade Accords in 2359.	
NCC-51824	U.S.S. <i>Helsinki</i>	Vladivostok-class
NCC-51825	U.S.S. <i>Warszawa</i>	Vladivostok-class
NCC-51826	U.S.S. <i>Yucatan</i>	Vladivostok-class
NCC-51827	U.S.S. <i>Zagreb</i>	Vladivostok-class
NCC-51967	U.S.S. <i>Great Smokey</i>	Steamrunner-class
NCC-52136	U.S.S. <i>Appalachia</i>	Steamrunner-class
	Starship that was among the vessels to defend Sector 001 against the Borg incursion of 2373.	
NCC-52232	U.S.S. <i>Normandie</i>	Hanseatic-class
NCC-52397	U.S.S. <i>Sulek</i>	Sulek-class
	Science vessel, first ship of her class.	
NCC-52398	U.S.S. <i>Mauretania</i>	Hanseatic-class
NCC-52400	U.S.S. <i>Columbus</i>	Hanseatic-class
NCC-53261	U.S.S. <i>Pusan</i>	Vladivostok-class
NCC-53446	U.S.S. <i>Matewan</i>	Steamrunner-class

NCC-53500

U.S.S. *Springfield*

Springfield-class

Starship, first of her class, approximately 325m long.

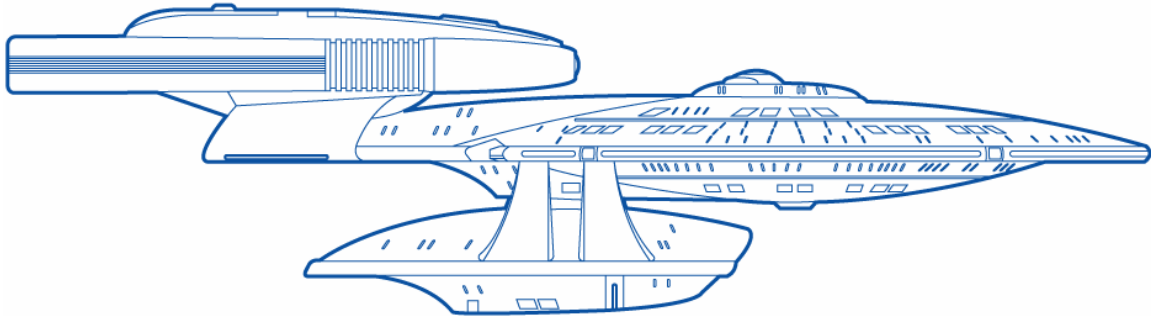

NCC-53742

U.S.S. *Tranquility*

Olympic-class

Destroyed by the Jem'Hadar in 2374, resulting in the deaths of the entire crew and 1500 patients.

NCC-53847

U.S.S. *Pegasus*

Oberth-class

Starship commanded by Captain Erik Pressman, the ship was a tested for several new system designs, including an experimental (and illegal) phasing cloak. The crew eventually mutinied, and only seven survived, including Pressman and William Riker. The ship suffered an "unphasing", leaving it imbedded in an asteroid. It was found by the U.S.S. *Enterprise* NCC-1701-D in 2370.

NCC-53858

U.S.S. *Karakorum*

Tenochtitlan-class

NCC-53906

U.S.S. *Sinai*

Vladivostok-class

NCC-53907

U.S.S. *Norrbotten*

Vladivostok-class

NCC-53911

U.S.S. *Tsiolkovsky*

Oberth-class

Ship, its crew of 80 was killed by a variant of the Psi 2000 virus in 2364. The ship was subsequently destroyed. The vessel's motto had been "*The Earth is the cradle of the mind, but one cannot remain in the cradle forever.*"

NCC-54216

U.S.S. *Moore*

Olympic-class

NCC-54344

U.S.S. *Great Western*

Hanseatic-class

NCC-54900

U.S.S. *Yorkshire*

Yorkshire-class

Transport vessel, first of her class.

NCC-54905

U.S.S. *Olympic*

Olympic-class

Starship, first of her class, designated a hospital ship. The vessel was approximately 320m long.

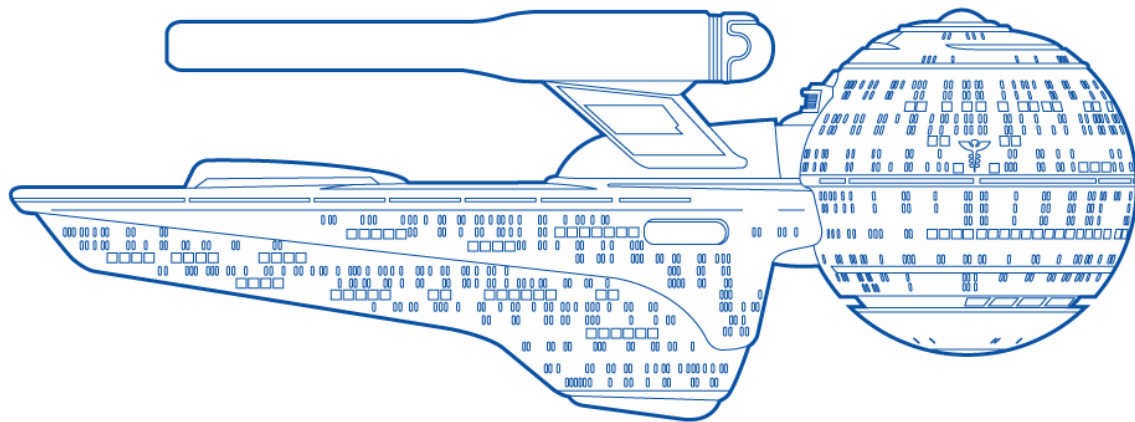

NCC-54927

U.S.S. *Denver*

Yorkshire-class

Transport vessel with a crew of 23, it struck a gravitic mine left over from the Cardassian wars in 2367. It crashed in the Mericor system while carrying 512 colonists. The U.S.S. *Enterprise* assisted with the rescue of the survivors.

NCC-55012	U.S.S. <i>Nobel</i>	Olympic-class
NCC-55203	U.S.S. <i>Shanghai</i>	Nebula-class
NCC-55376	U.S.S. <i>Stoneman</i>	Springfield-class
NCC-55469	U.S.S. <i>Orion</i>	Orion-class
	Dreadnought, the first starship of her class. Launched in 2335.	
NCC-55470	U.S.S. <i>Lancaster</i>	Orion-class
NCC-55471	U.S.S. <i>Ti Sha Kahn</i>	Orion-class
NCC-55472	U.S.S. <i>Star Union</i>	Orion-class
NCC-55473	U.S.S. <i>Brisbane</i>	Orion-class
NCC-55474	U.S.S. <i>Glasgow</i>	Orion-class
NCC-55938	U.S.S. <i>Cornwall</i>	Yorkshire-class
NCC-56399	U.S.S. <i>Pacifica</i>	Pacifica-class
	Starship, the first of her class, designated a light cruiser. Intended to be a supplement to the Excelsior-class, the ship was 445m long, 227m wide and 97m high, and had a crew compliment of 298.	
NCC-56636	U.S.S. <i>Caesar</i>	Caesar-class
	Research vessel, the first ship of her class. Launched in 2351, the ship was 212m long, 75m wide and 48m high. The saucer section is detachable, and is capable of entering the upper atmosphere of a gas giant, equipped with independent and redundant sensor systems. The ship had a crew compliment of 67.	

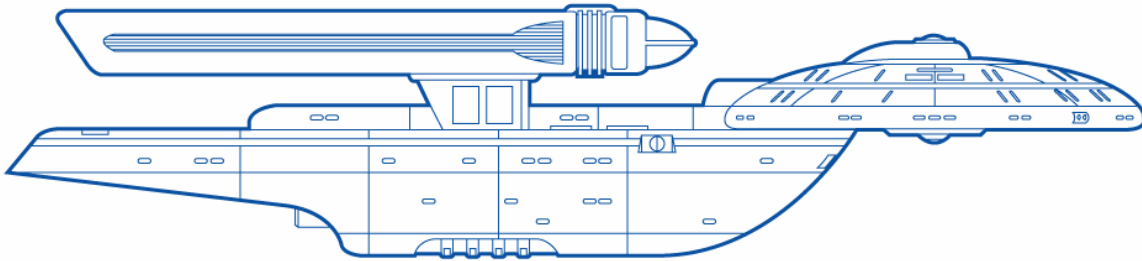

NCC-56676	U.S.S. <i>Joshua Tree</i>	Niagra-class
NCC-56762	U.S.S. <i>Colorado</i>	Tanganyika-Class
NCC-56763	U.S.S. <i>Aldebaran</i>	Tanganyika-Class
NCC-56764	U.S.S. <i>Democracy</i>	Tanganyika-Class
NCC-57036	U.S.S. <i>Queen Elizabeth</i>	Caesar-class
NCC-57111	U.S.S. <i>Tornado</i>	Splendor-class
NCC-57112	U.S.S. <i>Indefatigable</i>	Splendor-class
NCC-57113	U.S.S. <i>Cyclone</i>	Splendor-class
NCC-57210	U.S.S. <i>Khitomer</i>	Pacifica-class
NCC-57211	U.S.S. <i>Comet</i>	Pacifica-class
NCC-57212	U.S.S. <i>Viking</i>	Pacifica-class
NCC-57213	U.S.S. <i>Mariner</i>	Pacifica-class
NCC-57295	U.S.S. <i>Rutledge</i>	New Orleans-class
	Commanded by Captain Ben Maxwell during the Federation-Cardassian war. Miles O'Brien was tactical officer aboard the ship. The ship responded to an attack on outpost Setlik III, but was too late to prevent the massacre.	
NCC-57302	U.S.S. <i>Chekov</i>	Springfield-class
	One of the 39 starships destroyed at the 2367 Battle of Wolf 359 against the Borg.	
NCC-57400	U.S.S. <i>Chimera</i>	Chimera-class
	Starship, the first vessel of her class.	

NCC-57418	U.S.S. <i>Portland</i>	Chimera-class
NCC-57530	U.S.S. <i>Challenger</i>	Challenger-class
	Pathfinder vessel of the class, designated a destroyer.	

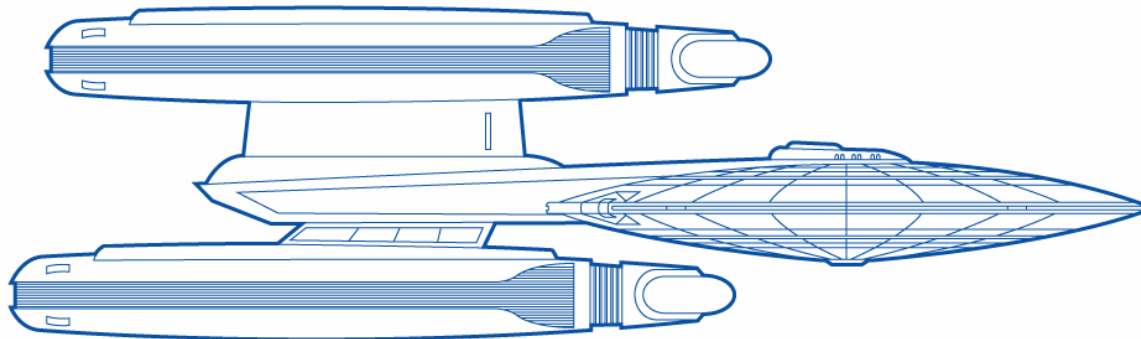

NCC-57537	U.S.S. <i>Armstrong</i>	Challenger-class
	Ship ambushed in 2373 by a Klingon battle group. Heavily damaged, it docked at station Deep Space Nine.	
NCC-57566	U.S.S. <i>Kearsarge</i>	Challenger-class
NCC-57580	U.S.S. <i>Buran</i>	Challenger-class
	One of the 39 ships lost at the Battle of Wolf 359 in 2367.	
NCC-57598	U.S.S. <i>Shogun</i>	Caesar-class
NCC-57734	U.S.S. <i>Arcturus</i>	Rigel-class
	Starship that discovered the Coreward Rift in 2355.	
NCC-57766	U.S.S. <i>Trident</i>	Trident-class
	Cargo ship, the first of her class. Small and modular, the ship was 117m long, 50m wide and 29m high. Launched in 2352, the ship had a crew compliment of 18.	

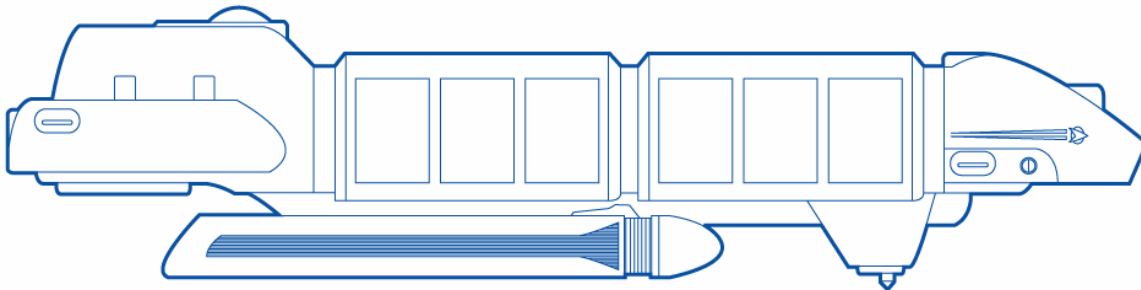

NCC-57767	U.S.S. <i>Delta</i>	Trident-class
NCC-57768	U.S.S. <i>Yankee Clipper</i>	Trident-class
NCC-57769	U.S.S. <i>Detroit</i>	Trident-class
NCC-57873	U.S.S. <i>Einstein</i>	Caesar-class
NCC-57890	U.S.S. <i>Kitty Hawk</i>	Caesar-class
NCC-57891	U.S.S. <i>Gamov</i>	Caesar-class
NCC-57892	U.S.S. <i>Hawking</i>	Caesar-class
NCC-57893	U.S.S. <i>Alcubierre</i>	Caesar-class
NCC-57942	U.S.S. <i>Kuala Lumpur</i>	Vladivostok-class
NCC-57943	U.S.S. <i>Patras</i>	Vladivostok-class
NCC-57944	U.S.S. <i>Zaragoza</i>	Vladivostok-class
NCC-57945	U.S.S. <i>Gold Coast</i>	Vladivostok-class
NCC-57946	U.S.S. <i>Schleswig-Holstein</i>	Vladivostok-class

NCC-58000	U.S.S. <i>Himalaya</i>	Himalaya-class Heavy cruiser, the first ship of her class. Launched in 2352, the ship was 515m long, 305m wide and 105m high. The ship had a crew compliment of 568.
NCC-58029	U.S.S. <i>Periyar</i>	Cheyenne-class
NCC-58502	U.S.S. <i>Fugger</i>	Trident-class
NCC-58503	U.S.S. <i>Medici</i>	Trident-class
NCC-58504	U.S.S. <i>Manila</i>	Trident-class
NCC-58672	U.S.S. <i>Jules Verne</i>	Caesar-class
NCC-58904	U.S.S. <i>Princeton</i>	Niagara-class One of the 39 ships lost at the Battle of Wolf 359 in 2367.
NCC-58928	U.S.S. <i>Pasteur</i>	Olympic-class Medical vessel with the motto " <i>I will give no deadly medicine to anyone if not asked, nor suggest any such counsel...</i> "-from the Hippocratic Oath.
NCC-59015	U.S.S. <i>Thims</i>	Niagra-class
NCC-59137	U.S.S. <i>Mayo</i>	Olympic-class
NCC-59261	U.S.S. <i>Hur'gaas</i>	Springfield-class
NCC-59318	U.S.S. <i>Cochrane</i>	Oberth-class
NCC-59319	U.S.S. <i>Darwin</i>	Oberth-class
NCC-59327	U.S.S. <i>Kalahari</i>	Vladivostok-class
NCC-59328	U.S.S. <i>Sumatra</i>	Vladivostok-class
NCC-59329	U.S.S. <i>Montevideo</i>	Vladivostok-class
NCC-59333	U.S.S. <i>Yokohama</i>	
NCC-59524	U.S.S. <i>Malta</i>	Tanganyika-Class
NCC-59525	U.S.S. <i>Kinshasa</i>	Tanganyika-Class
NCC-59526	U.S.S. <i>Humboldt</i>	Tanganyika-Class
NCC-59621	U.S.S. <i>Goddard</i>	Korolev-class Starship that served in the armada to blockade Romulan ships from supplying the Duras family in the short-lived Klingon Civil War of 2367-68.
NX-59650	U.S.S. <i>Prometheus</i>	Prometheus-class Prototype vessel, launched from the Beta Antares Shipyards on stardate 50749.5. Designed for deep-space tactical assignments, it boasted a multi-vector mode which effectively made it three ships in one. During one of it's early test flights it was overtaken by a group of Romulans, though control was regained by the ship's EMH. The ship's motto was " <i>All the world's a stage, and all the men and women merely players, they have their exits and their entrances and one man in his life plays many parts; his act being seven stages</i> "

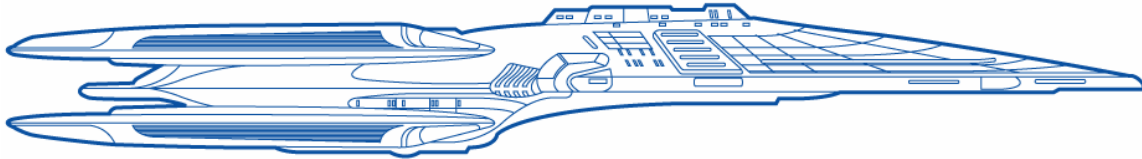

NCC-59680	U.S.S. <i>Orion</i>	Zodiac-class
NCC-59821	U.S.S. <i>Typhoon</i>	Hanseatic-class
NCC-59822	U.S.S. <i>Orca</i>	Hanseatic-class
NCC-59983	U.S.S. <i>Raman</i>	Oberth-class Ship with a crew of seven that was lost in the atmosphere of Marijne VII in 2370.
NCC-60000	U.S.S. <i>Moscow</i>	Moscow-class First starship of her class, designated a scout ship.

NCC-60001	U.S.S. <i>Argana</i>	Moscow-class
NCC-60002	U.S.S. <i>Leningrad</i>	Moscow-class
NCC-60003	U.S.S. <i>Balthamar</i>	Moscow-class
NCC-60004	U.S.S. <i>Jursinia</i>	Moscow-class
NCC-60005	U.S.S. <i>Kincara</i>	Moscow-class
NCC-60006	U.S.S. <i>Kloris</i>	Moscow-class
NCC-60007	U.S.S. <i>Mattermaine</i>	Moscow-class
NCC-60008	U.S.S. <i>Oslo</i>	Moscow-class
NCC-60009	U.S.S. <i>Chirpenitar</i>	Moscow-class
NCC-60010	U.S.S. <i>Murigami</i>	Moscow-class
NCC-60011	U.S.S. <i>Quiberon</i>	Moscow-class
NCC-60012	U.S.S. <i>Loris</i>	Moscow-class
NCC-60013	U.S.S. <i>Hadsenn</i>	Moscow-class
NCC-60014	U.S.S. <i>Silimari</i>	Moscow-class
NCC-60015	U.S.S. <i>Hadley</i>	Moscow-class
NCC-60016	U.S.S. <i>Florence</i>	Moscow-class
NCC-60017	U.S.S. <i>Milano</i>	Moscow-class
NCC-60018	U.S.S. <i>Stockholm</i>	Moscow-class
NCC-60019	U.S.S. <i>Ambergris</i>	Moscow-class
NCC-60020	U.S.S. <i>Oudinard</i>	Moscow-class
NCC-60021	U.S.S. <i>Petersburg</i>	Moscow-class
NCC-60023	U.S.S. <i>T'Pavis</i>	Niagra-class
NCC-60205	U.S.S. <i>Honshu</i>	Nebula-class
	Vessel destroyed by a wing of Cardassian destroyers on stardate 51408.6.	
NCC-60237	U.S.S. <i>Sirius</i>	Rigel-class
NCC-60246	U.S.S. <i>Barnard</i>	Rigel-class
	Destroyed by Dominion forces in 2374.	
NCC-60261	U.S.S. <i>Rutherford</i>	Pacifica-class
NCC-60262	U.S.S. <i>Gemini</i>	Pacifica-class
NCC-60263	U.S.S. <i>Osiris</i>	Pacifica-class
NCC-60500	U.S.S. <i>Mosquito</i>	Mosquito-class
	Vessel, the first of her class, a large runabout. Too large to operate from starship shuttle bays, the vessel, launched in 2354, was 69m long, 41m wide and 14m high. The ship required a crew of four.	

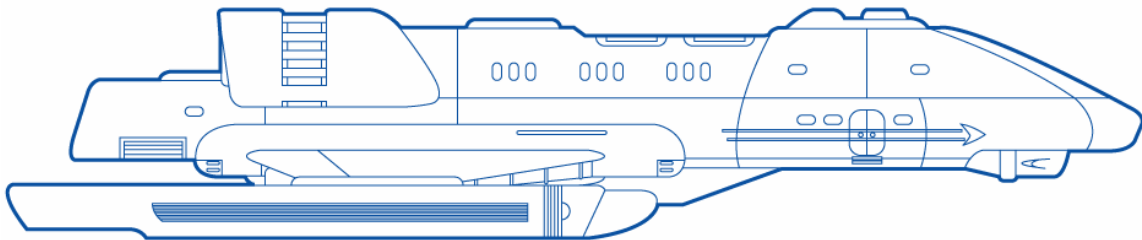

NCC-60508	U.S.S. <i>Fulgur</i>	Mosquito-class
NCC-60509	U.S.S. <i>Austin</i>	Mosquito-class
NCC-60510	U.S.S. <i>Veneto</i>	Mosquito-class
NCC-60541	U.S.S. <i>Chancellor</i>	Himalaya-class
NCC-60569	U.S.S. <i>Bounty</i>	

NCC-60597	U.S.S. <i>Farragut</i>	Nebula-class
	Destroyed by Klingon forces in 2373 near the Lembatta Cluster.	
NX-60602	U.S.S. <i>Nebula</i>	Nebula-class
	Prototype of her class, the <i>Nebula</i> was lost at the infamous Battle of Wolf 359. The <i>Nebula</i> was 350m long, with twenty-one decks and a crew of 550.	

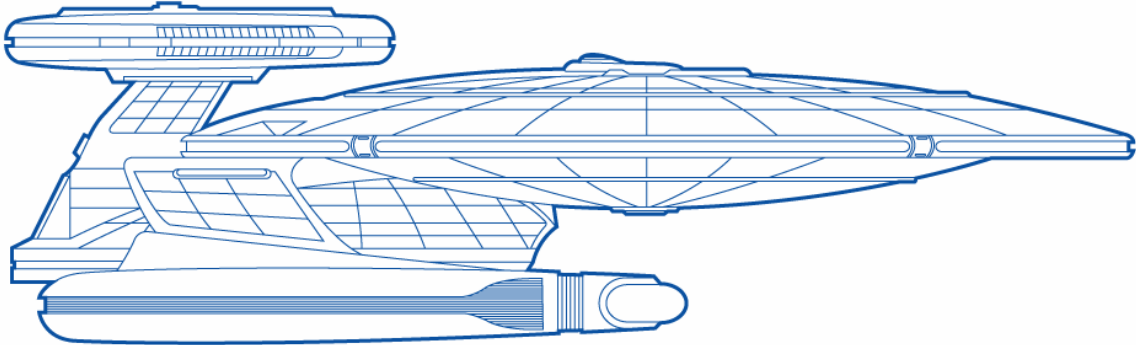

NCC-60632	U.S.S. <i>Bering</i>	Hanseatic-class
NCC-60633	U.S.S. <i>Marco Polo</i>	Hanseatic-class
NCC-60634	U.S.S. <i>Topaz</i>	Hanseatic-class
NCC-60651	U.S.S. <i>Victoria</i>	Arleigh Burke-class
NCC-60697	U.S.S. <i>Aida</i>	Mosquito-class
NCC-60698	U.S.S. <i>Red Sea</i>	Mosquito-class
NCC-60805	U.S.S. <i>Nightingale</i>	Nebula-class
	Used as a hospital-ship, commanded by Captain Nandi Jadeja.	
NCC-60977	U.S.S. <i>Caucasus</i>	Tanganyika-Class
NCC-60978	U.S.S. <i>Apache</i>	Tanganyika-Class
NCC-60979	U.S.S. <i>Centurion</i>	Tanganyika-Class
NCC-61000	U.S.S. <i>Zodiac</i>	Zodiac-class
	Vessel, prototype of her class.	
NCC-61137	U.S.S. <i>Yorktown</i>	Zodiac-class
NCC-61200	U.S.S. <i>Marian</i>	Trident-class
NCC-61225	U.S.S. <i>Kodiak</i>	Mosquito-class
NCC-61226	U.S.S. <i>Port-au-Prince</i>	Mosquito-class
NCC-61227	U.S.S. <i>Jervis</i>	Mosquito-class
NCC-61234	U.S.S. <i>Cygnus</i>	Himalaya-class
NCC-61529	U.S.S. <i>President</i>	Himalaya-class
NCC-61628	U.S.S. <i>Gathev</i>	Korolev-class
NCC-61694	U.S.S. <i>Seal</i>	Hanseatic-class
NCC-61695	U.S.S. <i>Robert Scott</i>	Hanseatic-class
NCC-61771	U.S.S. <i>Philadelphia</i>	Nebula-class
NCC-61801	U.S.S. <i>Darkstar</i>	Nebula-class
NCC-61809	U.S.S. <i>Bougainville</i>	Nebula-class
NCC-61826	U.S.S. <i>Monitor</i>	Nebula-class
	Destroyed in 2370.	
NCC-61827	U.S.S. <i>Merrimac</i>	Nebula-class
NCC-61829	U.S.S. <i>Ronald E. McNair</i>	
NCC-61832	U.S.S. <i>Lexington</i>	Nebula-class
	In 2371, the <i>Lexington</i> 's chief medical officer was Dr. Elizabeth Lense.	
NCC-61896	U.S.S. <i>Athena</i>	

NCC-61947	U.S.S. <i>Yeager</i>	Sabre-class	
	Part of a fleet that defended Sector 001 from the Borg in 2373.		
NCC-61952	U.S.S. <i>Proxima</i>	Nebula-class	
	Starship believe lost to Dominion forces in the Gamma Quadrant sometime prior to 2371.		
NCC-62000	U.S.S. <i>Rigel</i>	Rigel-class	
	First vessel of her class.		
NCC-62006	U.S.S. <i>Hera</i>	Nebula-class	
	Vessel that vanished in 2370 while under the command of Captain Silva LaForge with a crew of 300, mostly Vulcan.		
NCC-62010	U.S.S. <i>Chesapeake</i>	Nebula-class	
NCC-62043	U.S.S. <i>Melbourne</i>	Excelsior-class	
	One of the 39 ships destroyed at the 2367 Battle of Wolf 359. William Riker had been offered command of this ship in 2366.		
NCC-62045	U.S.S. <i>Sputnik</i>	Pacifica-class	
NCC-62046	U.S.S. <i>Dragon</i>	Pacifica-class	
NCC-62048	U.S.S. <i>Bellerophon</i>	Nebula-class	
NCC-62049	U.S.S. <i>Discovery</i>	Nebula-class	
NCC-62079	U.S.S. <i>Shepard</i>	Sabre-class	
	Destroyed in a Breen attack in 2375.		
NCC-62095	U.S.S. <i>Tolstoy</i>	Rigel-class	
	One of the 39 ships destroyed at the 2367 Battle of Wolf 359.		
NCC-62100	U.S.S. <i>T'Kumbra</i>	Nebula-class	
	Starship that had a Vulcan crew compliment.		
NCC-62123	U.S.S. <i>Philadelphia</i>	New Orleans-class	
NCC-62158	U.S.S. <i>Akagi</i>	Rigel-class	
	Starship that served in the armada to blockade Romulan supply ships during the short-lived Klingon civil war of 2367-68. In 2374, it was part of the Ninth Fleet, headquartered at Deep Space Nine.		
NCC-62304	U.S.S. <i>Triton</i>	Nebula-class	
NCC-62341	U.S.S. <i>Norway</i>	Norway-class	
	Prototype vessel of her class, a cruiser that was 365m long with 14 decks. It had a crew of 190, a maximum speed of warp 9.7 and was armed with Type X phasers and a compliment of 225 photon torpedoes.		

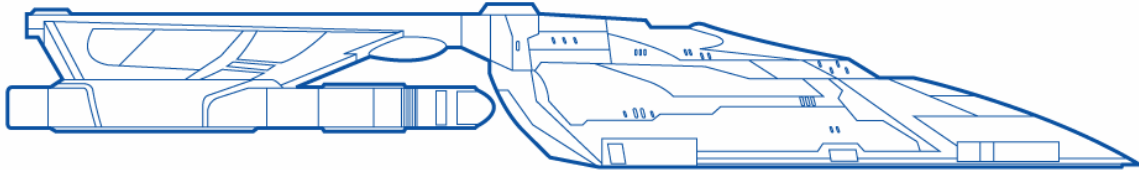

NCC-62344	U.S.S. <i>Leopard</i>	Nebula-class
NCC-62348	U.S.S. <i>Courageous</i>	Mosquito-class
NCC-62349	U.S.S. <i>Pallas</i>	Mosquito-class
NCC-62350	U.S.S. <i>East Anglia</i>	Mosquito-class
NCC-62351	U.S.S. <i>Belo Horizonte</i>	Mosquito-class

NCC-62497

U.S.S. *Akira*

Akira-class

First vessel of her class, commissioned in 2368. 465m long, the ship had 26 decks and a crew compliment of 500.

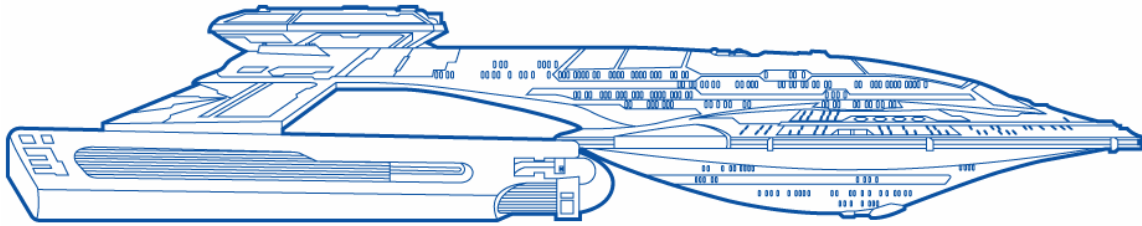

NCC-62498

U.S.S. *Macross*

NCC-62505

U.S.S. *Black Elk*

Akira-class

Starship lost along the Cardassian border in 2369.

NCC-62768

U.S.S. *Dolphin*

Caesar-class

NCC-62797

U.S.S. *Susquehanna*

Akira-class

Vessel that engaged the Tholians in 2371.

NCC-62799

U.S.S. *Tetsuo*

Akira-class

NCC-62845

U.S.S. *Polaris*

Rigel-class

NCC-62951

U.S.S. *Bolarus*

Pacifica-class

NCC-63002

U.S.S. *Mateo*

Akira-class

NCC-63100

U.S.S. *Coronado*

New Orleans-class

NCC-63102

U.S.S. *Renegade*

New Orleans-class

Starship commanded by Captain Tryla Scott in 2364.

NCC-63110

U.S.S. *Patrick Henry*

New Orleans-class

NCC-63293

U.S.S. *Rabin*

Akira-class

NCC-63368

U.S.S. *Deneb*

Rigel-class

NCC-63370

U.S.S. *Executioner*

NCC-63421

U.S.S. *Reliant*

Norway-class

NCC-63544

U.S.S. *Arthur C. Clarke*

NCC-63549

U.S.S. *Thunderchild*

Akira-class

Starship that defended Sector 001 from the Borg in 2373.

NCC-63587

U.S.S. *Kumano*

Mosquito-class

NCC-63588

U.S.S. *Baleares*

Mosquito-class

NCC-63678

U.S.S. *Adirondack*

Steamrunner-class

NCC-63718

U.S.S. *Yabrud*

Sequoia-class

NCC-63749

U.S.S. *Sutter*

Steamrunner-class

NCC-63798

U.S.S. *Harbinger*

Akira-class

NCC-63799

U.S.S. *Stealth*

Akira-class

NCC-63801

U.S.S. *Deathwatch*

Akira-class

NCC-63850

U.S.S. *Tokyo*

Akira-class

NCC-63856

U.S.S. *Gryphon*

Akira-class

NCC-63977

U.S.S. *Lydia*

Trident-class

NCC-63978

U.S.S. *Alpes Montes*

Trident-class

NCC-63979

U.S.S. *Uttar Pradesh*

Trident-class

NCC-63980

U.S.S. *Tolkien*

Trident-class

NCC-64088

U.S.S. *Devore*

Akira-class

NCC-64191

U.S.S. *Capricorn*

Pacifica-class

NCC-64192

U.S.S. *Chesapeake*

Mosquito-class

NCC-64264	U.S.S. <i>Deneva</i>	Tanganyika-Class
NCC-64265	U.S.S. <i>Whale</i>	Tanganyika-Class
NCC-64266	U.S.S. <i>Bayern</i>	Tanganyika-Class
NCC-64267	U.S.S. <i>Harare</i>	Tanganyika-Class
NCC-64275	U.S.S. <i>Richmond</i>	Springfield-class
NCC-64296	U.S.S. <i>Vega</i>	Rigel-class
NCC-64318	U.S.S. <i>Savannah</i>	Chesapeake-class
NCC-64552	U.S.S. <i>Laputa</i>	
NCC-64590	U.S.S. <i>Wanderer</i>	Steamrunner-class
NCC-64720	U.S.S. <i>Berkley</i>	Nebula-class
	Commanded by Elizabeth Haley.	
NCC-64923	U.S.S. <i>Budapest</i>	Norway-class
	Starship that defended Sector 001 from the Borg in 2373.	
NCC-64967	U.S.S. <i>Grigni</i>	Bradbury-class
NCC-65001	U.S.S. <i>Prague</i>	Norway-class
NCC-65013	U.S.S. <i>Denmark</i>	Norway-class
NCC-65042	U.S.S. <i>Lyra</i>	Zodiac-class
NCC-65054	U.S.S. <i>Luxembourg</i>	Norway-class
	Starship destroyed at the 2374 Battle of Tyra.	
NCC-65073	U.S.S. <i>Belgium</i>	Norway-class
NCC-65110	U.S.S. <i>Texas</i>	Himalaya-class
	U.S.S. <i>Arian</i>	Norway-class
NCC-65129	U.S.S. <i>Triumph</i>	Norway-class
NCC-65203	U.S.S. <i>Circassia</i>	Steamrunner-class
NCC-65237	U.S.S. <i>Boa Vista</i>	Tanganyika-Class
NCC-65238	U.S.S. <i>Freetown</i>	Tanganyika-Class
NCC-65239	U.S.S. <i>Falcon</i>	Tanganyika-Class
NCC-65387	U.S.S. <i>Temeraire</i>	Nebula-class
NCC-65420	U.S.S. <i>Phoenix</i>	Nebula-class
	Ship commanded by Captain Ben Maxwell. He ordered an unauthorized attack on Cardassian forces near Sector 21503. He was relieved of command. The ship's motto was " <i>There will be an answer, let it be.</i> "	
NCC-65491	U.S.S. <i>Kyushu</i>	New Orleans-class
	One of the 39 starships destroyed at the 2367 Battle of Wolf 359.	
NCC-65530	U.S.S. <i>Thomas Paine</i>	New Orleans-class
	Starship commanded by Captain Rixx in 2364.	

NCC-65601

U.S.S. *Surak*
First starship of her class.

Surak-class

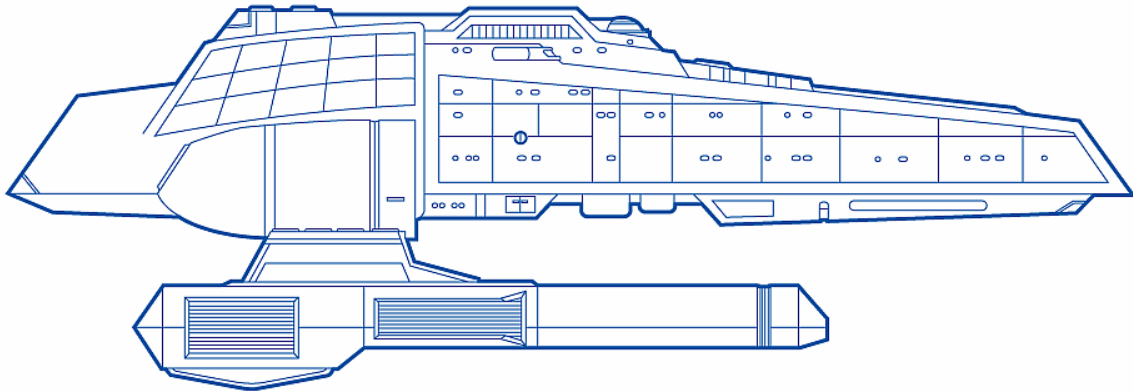

NCC-65674

U.S.S. *Yeager*

NCC-65724

U.S.S. *Mojave*

Trident-class

NCC-65725

U.S.S. *Yekaterinburg*

Trident-class

NCC-65739

U.S.S. *Star City*

Mosquito-class

NCC-65740

U.S.S. *Ark Royal*

Mosquito-class

NCC-65741

U.S.S. *Prince*

Mosquito-class

NCC-65897

U.S.S. *Tripoli*

NCC-66205

U.S.S. *Cosmos*

Pacifica-class

NCC-66206

U.S.S. *Bohr*

Pacifica-class

NCC-66207

U.S.S. *Peary*

Pacifica-class

NCC-66613

U.S.S. *Khitomer*

Nebula-class

Commanded by Captain Jae Yi.

NCC-66734

U.S.S. *Jefferies*

Himalaya-class

NCC-66735

U.S.S. *Ariel*

Himalaya-class

NCC-66808

U.S.S. *Ulysses*

Nebula-class

Starship under the command of Captain Entebe in 2371.

NCC-66888

U.S.S. *Pathfinder*

Mosquito-class

NCC-67016

U.S.S. *Liberator*

One of the 39 starships lost to the Borg in the 2367 Battle of Wolf 359, it's shuttlecraft #7 was named *Kotoi*.

NCC-67132

U.S.S. *Bootes*

Zodiac-class

NCC-67243

U.S.S. *Utrecht*

Cheyenne-class

NCC-67626

U.S.S. *Panther*

Kyuga-class

NCC-67983

U.S.S. *Votos*

NCC-68208

U.S.S. *Vanuatu*

Galaxy-class

NCC-68244

U.S.S. *Corona*

Pacifica-class

NCC-68468

U.S.S. *Hippocrates*

Olympic-class

NCC-68599

U.S.S. *Stockholm*

Himalaya-class

NCC-68700

U.S.S. *Freedom*

Freedom-class

First vessel of her class.

NCC-68711

U.S.S. *Concord*

Freedom-class

NCC-68723

U.S.S. *Firebrand*

Freedom-class

One of the 39 starships destroyed at the 2367 Battle of Wolf 359.

NCC-68749

U.S.S. *Lu'ghara*

Sabre-class

NCC-68752	U.S.S. <i>Baffinland</i>	Mosquito-class
NCC-68775	U.S.S. <i>Helena</i>	Caesar-class
NCC-68776	U.S.S. <i>Curie</i>	Caesar-class
NCC-68777	U.S.S. <i>Okazaki</i>	Caesar-class
NCC-68814	U.S.S. <i>Prokofiev</i>	Andromeda-class
NCC-68923	U.S.S. <i>Peacock</i>	Mosquito-class
NCC-68924	U.S.S. <i>Kalvos</i>	Andromeda-class
	U.S.S. <i>Salzburg</i>	Mosquito-class
NCC-68925	U.S.S. <i>Kensington</i>	Mosquito-class
NCC-68926	U.S.S. <i>Arrow</i>	Mosquito-class
NCC-68927	U.S.S. <i>Brandenburg</i>	Mosquito-class
NCC-69001	U.S.S. <i>Swansea</i>	Galaxy-class
NCC-69115	U.S.S. <i>Parallax</i>	Caesar-class
NCC-69116	U.S.S. <i>De Broglie</i>	Caesar-class
NCC-69117	U.S.S. <i>Fermi</i>	Caesar-class
NCC-69118	U.S.S. <i>Heisenberg</i>	Caesar-class
NCC-69130	U.S.S. <i>Benton</i>	Galaxy-class
NCC-69178	U.S.S. <i>Van Den Broeck</i>	Nova-class
NCC-69337	U.S.S. <i>Buenos Aires</i>	Buenos Aires-class
NCC-69338	U.S.S. <i>Den Haag</i>	Buenos Aires-class
NCC-69339	U.S.S. <i>Calcutta</i>	Buenos Aires-class
NCC-69427	U.S.S. <i>Duncan</i>	Trident-class
NCC-69428	U.S.S. <i>Assuan</i>	Trident-class
NCC-69429	U.S.S. <i>Southern Cross</i>	Trident-class
NCC-69456	U.S.S. <i>St Pertersburg</i>	Buenos Aires-class
NCC-69457	U.S.S. <i>Canberra</i>	Buenos Aires-class
NCC-69458	U.S.S. <i>Frankfurt</i>	Buenos Aires-class
NCC-69459	U.S.S. <i>Lagos</i>	Buenos Aires-class
NCC-69460	U.S.S. <i>Brazzaville</i>	Buenos Aires-class
NCC-69461	U.S.S. <i>Marseille</i>	Buenos Aires-class
NCC-69513	U.S.S. <i>Brasilia</i>	Buenos Aires-class
NCC-69514	U.S.S. <i>Kyoto</i>	Buenos Aires-class
NCC-69531	U.S.S. <i>Storta</i>	Sabre-class
NCC-69782	U.S.S. <i>Eagle</i>	Eagle-class

First vessel of her class, designated a heavy cruiser. The ship, launched in 2361, had a crew compliment of 432, and was 362m long, 263m wide and 96m high.

NCC-69783	U.S.S. <i>Pax</i>	Eagle-class
NCC-69796	U.S.S. <i>Liberty</i>	Eagle-class
NCC-69825	U.S.S. <i>Aldrin</i>	Yeager-class
NCC-69846	U.S.S. <i>Veldar</i>	Sabre-class
NCC-69847	U.S.S. <i>Castor</i>	Eagle-class
NCC-69848	U.S.S. <i>Pollux</i>	Eagle-class
NCC-69858	U.S.S. <i>Durandal</i>	Akira-class

One of the 39 starships destroyed by the Borg at the 2367 Battle of Wolf 359.

NCC-69862	U.S.S. <i>Senator</i>	Himalaya-class
NCC-69903	U.S.S. <i>Osiris</i>	Nebula-class
NCC-69925	U.S.S. <i>Avenger</i>	Akira-class

NCC-69942	U.S.S. <i>Devonshire</i>	Mosquito-class
NCC-69985	U.S.S. <i>Algonkin</i>	Mosquito-class
NCC-69986	U.S.S. <i>New Mexico</i>	Mosquito-class
NCC-70046	U.S.S. <i>Preble</i>	Coontz-class
NCC-70070	U.S.S. <i>Sequoia</i>	Sequoia-class
	Transport vessel, the first ship of her class.	
NCC-70071	U.S.S. <i>Hydra</i>	Hydra-class
	Escort vessel, the first of her class. Launched in 2361, the ship was 139m long, 76m wide and 29 m tall. Its standard crew compliment was 25 persons.	
NCC-70073	U.S.S. <i>Yellowstone</i>	Sequoia-class
NCC-70100	U.S.S. <i>Hannibal</i>	Ambassador-class
	Destroyed.	
NCC-70110	U.S.S. <i>Visigoth</i>	Norway-class
NCC-70114	U.S.S. <i>Endurance</i>	Columbia-class
NCC-70237	U.S.S. <i>Everglades</i>	Sequoia-class
NCC-70253	U.S.S. <i>Krechet</i>	Eagle-class
NCC-70254	U.S.S. <i>Providence</i>	Eagle-class
NCC-70258	U.S.S. <i>Denali</i>	Nebula-class
NCC-70270	U.S.S. <i>Couote</i>	Akira-class
NCC-70312	U.S.S. <i>Fabrux</i>	Fabrux-class
	Tender, the first starship of her class. Launched in 2359, the vessel was 238m long, 150m wide and 50m high, with a crew of 120. The class was named after the first Bolian to enter orbit the Bolian homeworld.	
NCC-70313	U.S.S. <i>Apogee</i>	Fabrux-class
NCC-70314	U.S.S. <i>Prixxoral</i>	Fabrux-class
NCC-70315	U.S.S. <i>Colbert</i>	Fabrux-class
NCC-70316	U.S.S. <i>Nutter</i>	Fabrux-class
NCC-70317	U.S.S. <i>Rapp</i>	Fabrux-class
NCC-70318	U.S.S. <i>Yande</i>	Fabrux-class
NCC-70319	U.S.S. <i>Hannawah</i>	Fabrux-class
NCC-70320	U.S.S. <i>McReynolds</i>	Fabrux-class
NCC-70321	U.S.S. <i>Swantak</i>	Fabrux-class
NCC-70328	U.S.S. <i>Gemini</i>	Yeager-class
NCC-70352	U.S.S. <i>Leeds</i>	Nebula-class
NCC-70359	U.S.S. <i>Damara</i>	Bradbury-class
NCC-70388	U.S.S. <i>San Diego</i>	Buenos Aires-class
NCC-70389	U.S.S. <i>Nairobi</i>	Buenos Aires-class
NCC-70395	U.S.S. <i>Triangulum</i>	Trident-class
NCC-70396	U.S.S. <i>Sagittarius</i>	Trident-class
NCC-70556	U.S.S. <i>Idaho</i>	Eagle-class
NCC-70564	U.S.S. <i>Ronald D. Moore</i>	Galaxy-class
	Vessel named for a famous Starfleet admiral.	
NCC-70573	U.S.S. <i>Cherokee</i>	Eagle-class
NCC-70574	U.S.S. <i>Triton</i>	Eagle-class

NCC-70611

U.S.S. *Cheyenne*

Cheyenne-class

First starship of her class, 362m long.

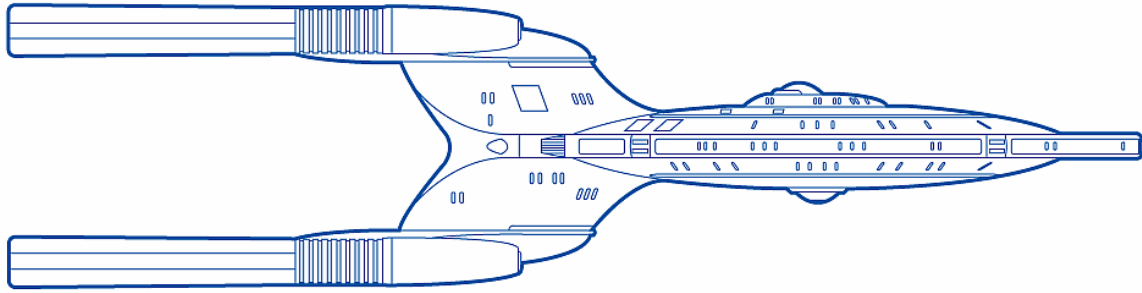

NX-70637

U.S.S. *Galaxy*

Galaxy-class

Pathfinder of her class, the *Galaxy* was 642.51m long, 468.73m wide and 195.26m high, with 42 decks. The ship was armed with 11 Type X phaser emitters and two torpedo launchers. Launched in 2356. Crewed by 1012 persons, the ship was seriously damaged in the battle for the Chin'toka system in late 2374.

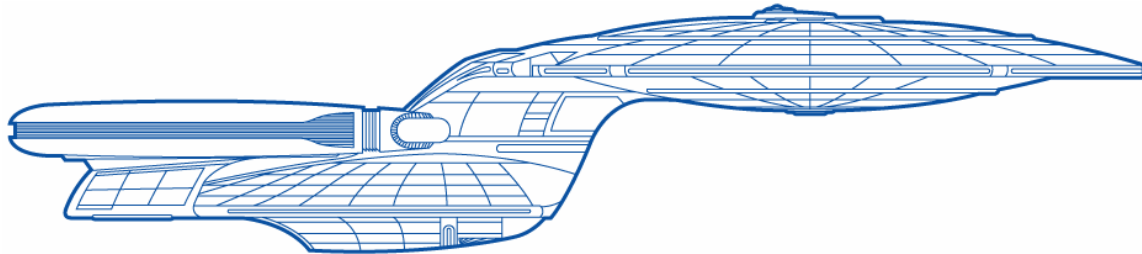

NCC-70669

U.S.S. *Prudence*

Prudence-class

Heavy cruiser, the first ship of her class. A variant of the Eagle-class, the ship was launched in 2361 with a crew of 437. The ship was 377m long, 263m wide and 83m tall.

NCC-70670

U.S.S. *Pegasus*

Prudence-class

NCC-70671

U.S.S. *Friendship*

Prudence-class

NCC-70752

U.S.S. *Paiute*

Cheyenne-class

Destroyed in 2374.

NCC-70856

U.S.S. *Ishtar*

Galaxy-class

NCC-70862

U.S.S. *Baghdad*

Buenos Aires-class

NCC-70863

U.S.S. *Anchorage*

Buenos Aires-class

NCC-70864

U.S.S. *Quebec*

Buenos Aires-class

NCC-70915

U.S.S. *Bonchune*

Nebula-class

NCC-70956

U.S.S. *Drake*

Andromeda-class

Vessel ambushed by a Klingon battle group in 2373.

NCC-70982

U.S.S. *Forrestal*

Eagle-class

NCC-70983

U.S.S. *Nebraska*

Eagle-class

NCC-70984

U.S.S. *Niedersachsen*

Eagle-class

NCC-70985

U.S.S. *Ogaden*

Eagle-class

NCC-70986

U.S.S. *Flagstaff*

Sequoia-class

NCC-71038

U.S.S. *Nevsky*

Galaxy-class

NCC-71055

U.S.S. *Napoli*

Buenos Aires-class

NCC-71056

U.S.S. *Beijing*

Buenos Aires-class

NCC-71057

U.S.S. *Rangoon*

Buenos Aires-class

NCC-71093

U.S.S. *Hentar*

Galaxy-class

NCC-71095	U.S.S. <i>Kludy</i> Destroyed by Cardassian forces in 2375.	Galaxy-class
NCC-71099	U.S.S. <i>Challenger</i>	Galaxy-class
NCC-71184	U.S.S. <i>Ramses</i> Escort vessel, the first of her class, launched in 2366. The ship had a standard crew of 89. It was 214m long, 124m wide, with a height of 48m.	Ramses-class
NCC-71201	U.S.S. <i>Prometheus</i>	Nebula-class
NCC-71205	U.S.S. <i>Bertram</i>	Sequoia-class
NCC-71229	U.S.S. <i>Alexander</i>	
NCC-71230	U.S.S. <i>Charlemagne</i>	Ramses-class
NCC-71231	U.S.S. <i>Napoleon</i>	Ramses-class
NCC-71232	U.S.S. <i>Victoria</i>	Ramses-class
NCC-71242	U.S.S. <i>Weber</i>	Aegian-class
NCC-71245	U.S.S. <i>Charles de Gaulle</i>	Ramses-class
NCC-71246	U.S.S. <i>Friedrich II</i>	Ramses-class
NCC-71247	U.S.S. <i>Leonardo da Vinci</i>	Ramses-class
NCC-71248	U.S.S. <i>Mary Stuart</i>	Ramses-class
NCC-71246	U.S.S. <i>Pel-Gaash</i>	Galaxy-class
NCC-71274	U.S.S. <i>Libra</i>	Zodiac-class
NCC-71275	U.S.S. <i>Scorpio</i>	Zodiac-class
NCC-71276	U.S.S. <i>Sagittarius</i>	Zodiac-class
NCC-71349	U.S.S. <i>Faithful</i>	Miranda-class
NCC-71388	U.S.S. <i>Walker</i>	Fabrux-class
NCC-71389	U.S.S. <i>Delmonica</i>	Fabrux-class
NCC-71390	U.S.S. <i>Carlson</i>	Fabrux-class
NCC-71391	U.S.S. <i>Ellis</i>	Fabrux-class
NCC-71392	U.S.S. <i>Advantage</i>	Fabrux-class
NCC-71393	U.S.S. <i>Shelton</i>	Fabrux-class
NCC-71394	U.S.S. <i>Artale</i>	Fabrux-class
NCC-71395	U.S.S. <i>Shermer</i>	Fabrux-class
NCC-71396	U.S.S. <i>Rittman</i>	Fabrux-class
NCC-71397	U.S.S. <i>Gerratana</i>	Fabrux-class
NCC-71398	U.S.S. <i>Schneider</i>	Fabrux-class
NCC-71399	U.S.S. <i>Keith</i>	Fabrux-class
NCC-71400	U.S.S. <i>Klamazoo</i>	Fabrux-class
NCC-71401	U.S.S. <i>Hammerfest</i>	Fabrux-class
NCC-71402	U.S.S. <i>Iraklion</i>	Fabrux-class
NCC-71403	U.S.S. <i>Nee</i>	Fabrux-class
NCC-71404	U.S.S. <i>Regent</i>	Fabrux-class
NCC-71405	U.S.S. <i>Roraima</i>	Fabrux-class
NCC-71406	U.S.S. <i>Boxxal Mat</i>	Fabrux-class
NCC-71543	U.S.S. <i>James Cook</i>	Ramses-class
NCC-71544	U.S.S. <i>Nelson</i>	Ramses-class
NCC-71580	U.S.S. <i>Rühl</i>	Fabrux-class
NCC-71581	U.S.S. <i>Martin</i>	Fabrux-class
NCC-71582	U.S.S. <i>Herald</i>	Fabrux-class
NCC-71583	U.S.S. <i>Bohn</i>	Fabrux-class

NCC-71584	U.S.S. <i>Smith</i>	Fabrux-class
NCC-71620	U.S.S. <i>Ahwahnee</i>	Cheyenne-class
NCC-71627	U.S.S. <i>Jupiter</i>	Akira-class
	Starship that was a testbed for experimental chain-pulse weapons array; commanded by Captain Satelk.	
NCC-71669	U.S.S. <i>Socrates</i>	Ramses-class
NCC-71670	U.S.S. <i>Augustus</i>	Ramses-class
NCC-71777	U.S.S. <i>Ta'veret</i>	Chimera-class
NCC-71805	U.S.S. <i>Endeavour</i>	Nebula-class
	Starship commanded by Captain Amasov, it was the only starship to fully survive the 2367 Battle of Wolf 359. It served in the blockade during the short-lived Klingon civil war and it was part of the task force that intercepted a Borg cube at Earth on stardate 50893.	
NCC-71807	U.S.S. <i>Yamato</i>	Galaxy-class
	Second ship of her class, commanded by Captain Donald Varley. It was destroyed by an ancient Iconian computer software weapon. The ship's motto had been " <i>I have sworn eternal hostility against every form of tyranny over the mind of man</i> ".	
NCC-71820	U.S.S. <i>Magellan</i>	Galaxy-class
NCC-71832	U.S.S. <i>Odyssey</i>	Galaxy-class
	Starship commanded by Captain Keogh, it was destroyed in the Gamma Quadrant by three Jem'Hadar ships. It's motto had been " <i>It's origin and purpose, still a total mystery</i> ".	
NCC-71854	U.S.S. <i>Venture</i>	Galaxy-class
NCC-71867	U.S.S. <i>Trinculo</i>	Galaxy-class
NCC-71874	U.S.S. <i>Sabah</i>	Mosquito-class
NCC-71875	U.S.S. <i>Mombasa</i>	Mosquito-class
	U.S.S. <i>Bright Star</i>	
NCC-71876	U.S.S. <i>Hessen</i>	Mosquito-class
NCC-71879	U.S.S. <i>Dauntless</i>	Galaxy-class
NCC-71900	U.S.S. <i>Cleopatra</i>	Ramses-class
NCC-71901	U.S.S. <i>Churchill</i>	Ramses-class
NCC-71902	U.S.S. <i>Solomon</i>	Ramses-class
NCC-71903	U.S.S. <i>Nimitz</i>	Ramses-class
NCC-71935	U.S.S. <i>Boston</i>	Freedom-class
NCC-71954	U.S.S. <i>Helix</i>	Nova-class
NCC-71982	U.S.S. <i>Santa Ana</i>	
NCC-71992	U.S.S. <i>Kaskaskia</i>	
NCC-72000	U.S.S. <i>Sasser</i>	Sasser-class
	Starship, the first vessel of her class. Designated a cruiser by Starfleet.	

NX-72003

U.S.S. *Danube*

Danube-class

Pathfinder of her class, a runabout. Constructed at Utopia Planitia in 2365 it began flight trials in 2367. 23.1m long, 13.7m wide and 5.4m high.

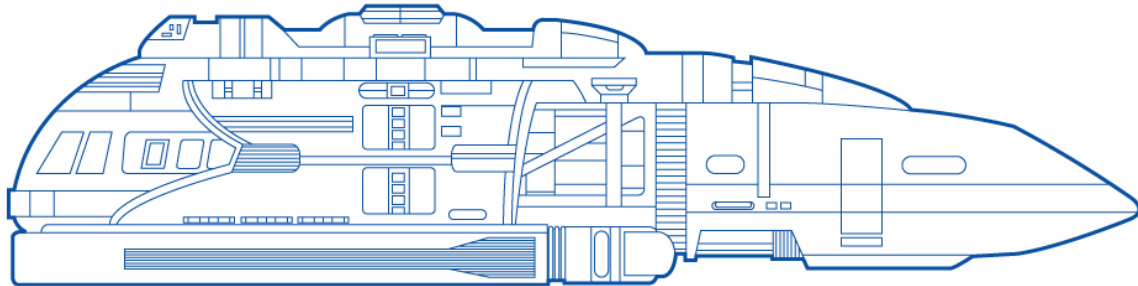

NCC-72015

U.S.S. *Sutherland*

Nebula-class

Commissioned stardate 44820.5 from the San Francisco Fleet Yards, it served in the armada to blockade Romulan supply ships in the 2367 Klingon civil war. The ship's motto was "*There will be an answer, let it be*". In 2373, the ship was under the command of Captain Shelby.

NCC-72032

U.S.S. *Orca*

Orca-class

First vessel of her class, designated a dreadnought.

NCC-72035

U.S.S. *Patria*

Patria-class

Explorer, the first ship of her class. Commissioned in 2368, the ship was 656m long, 344m wide and 123m high, with a standard crew of 952.

NCC-72069

U.S.S. *Werner von Braun*

NCC-72081

U.S.S. *Sarek*

Galaxy-class

NCC-72146

U.S.S. *Janeng*

Chimera-class

Starship that participated in the final attack on Cardassia Prime in 2375.

NCC-72201

U.S.S. *Krazny Oktaybr*

NCC-72204

U.S.S. *King Arthur*

NCC-72229

U.S.S. *Romanov*

Eagle-class

NCC-72239

U.S.S. *Jefferson*

Ramses-class

NCC-72240

U.S.S. *Shaka Zulu*

Ramses-class

NCC-72241

U.S.S. *Montezuma*

Ramses-class

NCC-72265

U.S.S. *Phobos*

Mosquito-class

NCC-72266

U.S.S. *Deimos*

Mosquito-class

NCC-72267

U.S.S. *Hotspur*

Mosquito-class

NCC-72268

U.S.S. *Malibu*

Mosquito-class

NCC-72275

U.S.S. *Alexander*

Ramses-class

NCC-72276

U.S.S. *Cheops*

Ramses-class

NCC-72301

U.S.S. *Overfield*

Overfield-class

Prototype vessel, first ship of her class.

NX-72307

U.S.S. *Bradbury*

Bradbury-class

Pathfinder vessel of her class. Launched 2366.

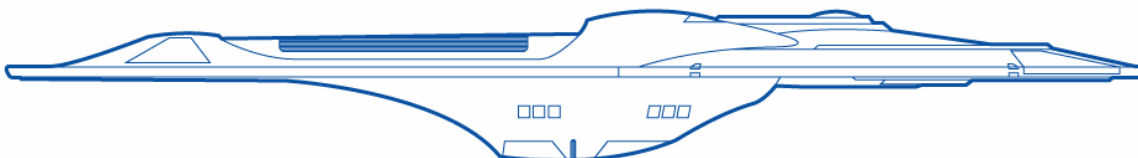

NCC-72315

U.S.S. *LaRue*

Sabre-class

NCC-72321

U.S.S. *Aurora*

Nova-class

NX-72330

U.S.S. *Nova*

Nova-class

First vessel of her class, a scout/science vessel.

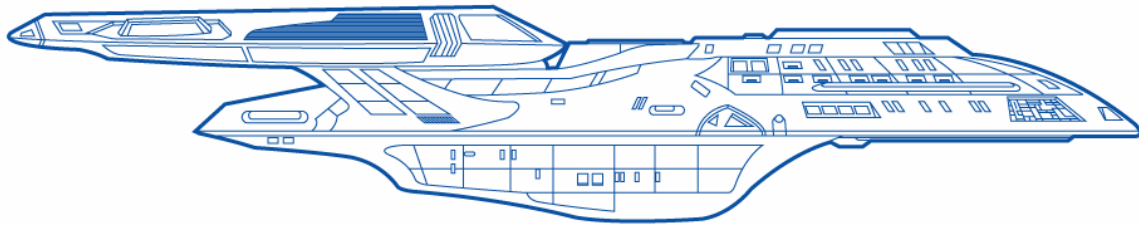

NCC-72358

U.S.S. *Pulsar*

Nova-class

NCC-72369

U.S.S. *Quasar*

Nova-class

NCC-72370

U.S.S. *Noble*

Nova-class

NCC-72381

U.S.S. *Equinox*

Nova-class

Starship launched stardate 47007.1, it became lost and ended up in the Delta Quadrant. It's motto had been "*The night of time far surpasseth the day*".

NCC-72406

U.S.S. *Vel'dna*

Galaxy-class

NCC-72409

U.S.S. *Solstice*

Nova-class

NCC-72411

U.S.S. *Freeman Dyson*

Nova-class

NCC-72452

U.S.S. *Rio Grande*

Danube-class

Runabout assigned to Deep Space Nine.

NCC-72453

U.S.S. *Yangtze Kiang*

Danube-class

Runabout assigned to Deep Space Nine. Destroyed when it crashed on a moon in the Gamma Quadrant.

NCC-72454

U.S.S. *Ganges*

Danube-class

Runabout assigned to Deep Space Nine. Destroyed in 2370.

NCC-72455

U.S.S. *Yucatan*

Danube-class

NCC-72469

U.S.S. *Kern*

Danube-class

NCC-72491

U.S.S. *Haida*

Cheyenne-class

NCC-72579

U.S.S. *Courageous*

Galaxy-class

NCC-72590

U.S.S. *Mississippi*

Danube-class

Destroyed in the Gamma Quadrant in 2370 by the "Othersiders".

NCC-72617

U.S.S. *Mekong*

Danube-class

Runabout assigned to Deep Space Nine. Destroyed in 2371.

NCC-72687

U.S.S. *Truman*

Ramses-class

NCC-72688

U.S.S. *Peter the Great*

Ramses-class

NCC-72689

U.S.S. *Hammurabi*

Ramses-class

NCC-72701

U.S.S. *Rhode Island*

Nova-class

NCC-72790

U.S.S. *Lyon*

Hydra-class

NCC-72791

U.S.S. *Maui*

Hydra-class

NCC-72800

U.S.S. *Grand Alliance*

Grand Alliance-class

Starship, the first vessel of her class, designed as a fast diplomatic transport.

NCC-72846

U.S.S. *Harryhausen*

Shelley-class

NCC-72884

U.S.S. *Thessalonica*

NCC-72905

U.S.S. *Orinoco*

Danube-class

Runabout assigned to Deep Space Nine. Destroyed.

NCC-72936

U.S.S. *Rubicon*

Danube-class

Runabout assigned to Deep Space Nine.

NCC-73008

U.S.S. *Saloniemi*

Fabrux-class

NCC-73009

U.S.S. *Lombard*

Fabrux-class

NCC-73010	U.S.S. <i>Wilmington</i>	Fabrux-class
NCC-73011	U.S.S. <i>Bajkal</i>	Fabrux-class
NCC-73022	U.S.S. <i>Bremen</i>	Bremen-class
	Frigate, the first vessel of her class. Commissioned in 2369, the ship was 327m long, 106m wide and 61m high, with a crew compliment of 127.	
NCC-73026	U.S.S. <i>Rangoon</i>	
NCC-73036	U.S.S. <i>Edinburgh</i>	Bremen-class
NCC-73044	U.S.S. <i>Shenendoah</i>	Danube-class
NCC-73048	U.S.S. <i>Simms</i>	Shelley-class
NCC-73078	U.S.S. <i>Discovery</i>	Eagle-class
NCC-73079	U.S.S. <i>Flagstaff</i>	Eagle-class
NCC-73080	U.S.S. <i>Siegfried</i>	Eagle-class
NCC-73097	U.S.S. <i>Joyce</i>	Bradbury-class
	Vessel destroyed in the Tyra system in 2374.	
NCC-73105	U.S.S. <i>K'shal</i>	Nova-class
NCC-73112	U.S.S. <i>Tolkien</i>	Bradbury-class
NCC-73113	U.S.S. <i>Twarel</i>	Bradbury-class
NCC-73196	U.S.S. <i>Volga</i>	Danube-class
	Runabout assigned to Deep Space Nine.	
	U.S.S. <i>Martel</i>	Akira-class
NCC-73228	U.S.S. <i>Odyessy</i>	Aurora-class
NCC-73229	U.S.S. <i>Illiad</i>	Aurora-class
NCC-73240	U.S.S. <i>Yokohama</i>	Bremen-class
NCC-73241	U.S.S. <i>Baltimore</i>	Bremen-class
NCC-73242	U.S.S. <i>Luanda</i>	Bremen-class
NCC-73280	U.S.S. <i>Entente</i>	
NCC-73293	U.S.S. <i>Lionheart</i>	Hydra-class
NCC-73294	U.S.S. <i>Lalo</i>	Hydra-class
NCC-73295	U.S.S. <i>Palmero</i>	Bremen-class
NCC-73296	U.S.S. <i>Rostov</i>	Bremen-class
NCC-73333	U.S.S. <i>Qingdao</i>	Bremen-class
NCC-73462	U.S.S. <i>Indomitable</i>	Galaxy-class
NCC-73487	U.S.S. <i>Drake</i>	
	U.S.S. <i>Perikles</i>	Ramses-class
NCC-73488	U.S.S. <i>Solon</i>	Ramses-class
NCC-73489	U.S.S. <i>Homer</i>	Ramses-class
NCC-73490	U.S.S. <i>Garibaldi</i>	Ramses-class
NCC-73491	U.S.S. <i>Ataturk</i>	Ramses-class
NCC-73515	U.S.S. <i>Nova</i>	
NCC-73550	U.S.S. <i>Bishop</i>	Targa-class
NCC-73551	U.S.S. <i>Lancer</i>	Targa-class
NCC-73609	U.S.S. <i>Kennedy</i>	Eagle-class
NCC-73610	U.S.S. <i>Sahara</i>	Eagle-class
NCC-73611	U.S.S. <i>Hudson</i>	Eagle-class
NCC-73688	U.S.S. <i>Guam</i>	Bremen-class
NCC-73689	U.S.S. <i>Gibraltar</i>	Bremen-class

NX-73811

U.S.S. *Sovereign*

Sovereign-class

First vessel of her class, a heavy explorer. Launched in 2369 from the San Francisco Fleet Yards. 732m long with 24 decks, it has a standard crew of 1000.

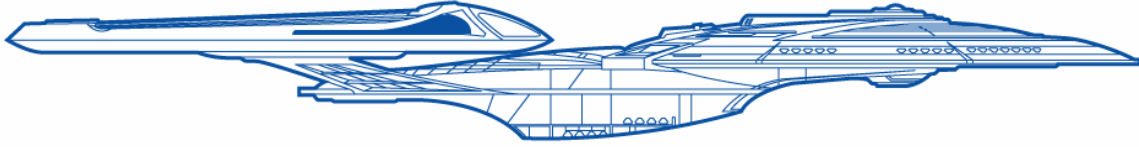

NCC-73849

U.S.S. *Massachusetts*

Patria-class

NCC-73853

U.S.S. *Equality*

Fabrux-class

NCC-73854

U.S.S. *Sharp*

Fabrux-class

NCC-73855

U.S.S. *Doddema*

Fabrux-class

NCC-73856

U.S.S. *Harot*

Fabrux-class

NCC-73857

U.S.S. *T'Var*

Fabrux-class

NCC-73858

U.S.S. *Haleb*

Fabrux-class

NCC-73859

U.S.S. *Valtane*

Fabrux-class

NCC-73869

U.S.S. *Kremlin*

Patria-class

NCC-73948

U.S.S. *Horizon*

Patria-class

NCC-73957

U.S.S. *Durban*

Buenos Aires-class

NCC-73958

U.S.S. *Lhasa*

Buenos Aires-class

NCC-73959

U.S.S. *Reykjavik*

Buenos Aires-class

NCC-73961

U.S.S. *Atlantis*

Patria-class

NCC-74073

U.S.S. *Fujisan*

Patria-class

NCC-74120

U.S.S. *Charhev*

Bradbury-class

Destroyed in 2375 by the Breen.

NCC-74121

U.S.S. *Elkins*

NCC-74184

U.S.S. *New Hampshire*

Mosquito-class

NCC-74185

U.S.S. *Excellent*

Mosquito-class

NCC-74186

U.S.S. *Bastille*

Mosquito-class

NX-74205

U.S.S. *Defiant*

Defiant-class

First ship of her class, and escort originally designed to fight the Borg. Assigned to Deep Space Nine under the command of Ben Sisko, it was 170.68m long, 134.11m wide and 30.1m high with four decks. Built at the Antares Fleet Yards at Antares IV, it was launched stardate 47538.5 with the motto "*All I ask is a tall ship and a star to steer her by*". It was destroyed in late 2375 by Breen forces.

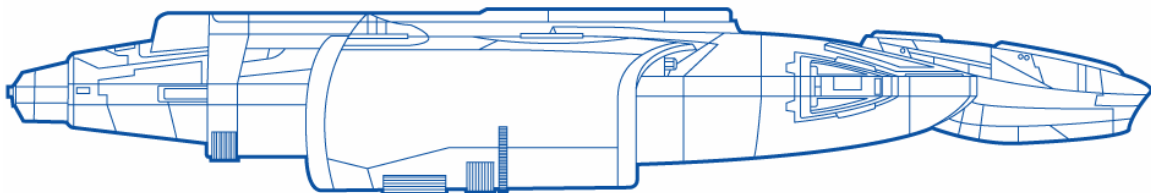

NCC-74206

U.S.S. *Gallant*

Defiant-class

Starship destroyed by a Cardassian Task Force along the Cardassian/Federation DMZ in 2372.

NCC-74210

U.S.S. *Valiant*

Defiant-class

Ship launched stardate 49456.5 from the Antares Ship Yards, under the command of Captain Ramirez and a crew of Red Squad cadets. The squad assumed command when the senior crew was killed in battle. The ship was

destroyed stardate 51825.4. The ship's motto had been "*We set sail on this new sea because there is new knowledge to be gained and new rights to be won*".

NCC-74215	U.S.S. <i>Rutledge</i>	
NCC-74225	U.S.S. <i>Tirana</i>	Bremen-class
	U.S.S. <i>Starlord</i>	
NCC-74368	U.S.S. <i>Soong</i>	Intrepid-class
NCC-74403	U.S.S. <i>Aristotle</i>	Nebula-class
NCC-74600	U.S.S. <i>Intrepid</i>	Intrepid-class

First ship of her class. Fifteen decks thick, the ship had a top speed of warp 9.975. Launched in 2370.

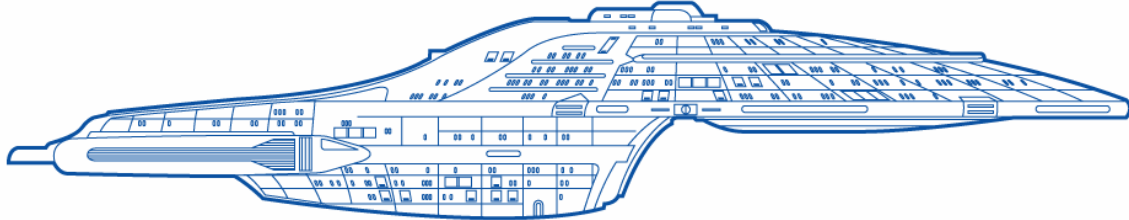

NCC-74602	U.S.S. <i>Yukon</i>	Danube-class
	Runabout assigned to Deep Space Nine, destroyed in 2373.	
NCC-74615	U.S.S. <i>Annhialate</i>	Defiant-class
NCC-74655	U.S.S. <i>Fiscus</i>	Intrepid-class
	Launched in 2371, the ship was destroyed in 2373	
NCC-74656	U.S.S. <i>Voyager</i>	Intrepid-class
	Launched from Earth Station McKinley on stardate 48038.5, the ship was violently propelled to the Delta Quadrant while under the command of Kathryn Janeway. It took the ship almost 8 years to traverse the 70,000 light years home, finally utilizing a Borg transwarp conduit to finish the journey. Command of the ship was later given to Chakotay. The ship's motto was " <i>For I dipt into the future, far as the human eye could see; Saw the Vision of the World and all the wonder that would be.</i> "	
NCC-74657	U.S.S. <i>Valhalla</i>	Sovereign-class
	Launched in 2373.	
	U.S.S. <i>Jutland</i>	Intrepid-class
NCC-74659	U.S.S. <i>Eagle</i>	Intrepid-class
NCC-74667	U.S.S. <i>Prevailing Wind</i>	Intrepid-class
NCC-74675	U.S.S. <i>Independence</i>	Intrepid-class
NCC-74691	U.S.S. <i>Destiny</i>	
NCC-74692	U.S.S. <i>Aurora</i>	Nova-class
NCC-74695	U.S.S. <i>Binary</i>	Nova-class
NCC-74697	U.S.S. <i>Trailblazer</i>	Intrepid-class
NCC-74700	U.S.S. <i>Challenger</i>	Intrepid-class
NCC-74703	U.S.S. <i>Kyuga</i>	Kyuga-class
	First vessel of her class, a scout.	
NCC-74705	U.S.S. <i>Bellerophon</i>	Intrepid-class
NCC-74711	U.S.S. <i>Cochrane</i>	
NCC-74711-A	U.S.S. <i>Cochrane</i>	Intrepid-class
NCC-74712	U.S.S. <i>Vor'kann</i>	Intrepid-class
NCC-74716	U.S.S. <i>Traveller</i>	
NCC-74718	U.S.S. <i>Nelson</i>	Intrepid-class
NCC-74732	U.S.S. <i>Zealous</i>	Intrepid-class

NX-74751	U.S.S. <i>Yellowstone</i>	Yellowstone-class
	Prototype for an advance runabout employing tetryon plasma warp nacelles.	
NCC-74800	U.S.S. <i>Excalibur</i>	Intrepid-class
NCC-74803	U.S.S. <i>Nadir</i>	Nova-class
NCC-74829	U.S.S. <i>Pulsar</i>	Nova-class
NCC-74854	U.S.S. <i>Solstice</i>	Nova-class
NCC-74882	U.S.S. <i>Gallant</i>	Intrepid-class
NCC-74900	U.S.S. <i>Katana</i>	Katana-class
	First vessel of her class, designated an escort vessel.	
NCC-74945	U.S.S. <i>Hannibal</i>	Hannibal-class
	Escort vessel, the first of her class, launched in 2372. Developed parallel to the Defiant-class, the ship was 189m long, 122m wide and 29m high, with a crew of 78.	
NCC-74982	U.S.S. <i>Camelot</i>	Intrepid-class
NCC-74986	U.S.S. <i>Daystrom</i>	Intrepid-class
NCC-74999	U.S.S. <i>Khitomer</i>	Sovereign-class
	Ship launched in 2373.	
NCC-75001	U.S.S. <i>Monitor</i>	Defiant-class
	U.S.S. <i>Cicero</i>	
NCC-75002	U.S.S. <i>Merrimac</i>	Defiant-class
NCC-75016	U.S.S. <i>Kensington</i>	
NCC-75055	U.S.S. <i>Sagan</i>	Intrepid-class
	Commanded by Captain Stuart.	
NCC-75063	U.S.S. <i>Ariane</i>	Hannibal-class
NCC-75064	U.S.S. <i>Luna</i>	Hannibal-class
NCC-75080	U.S.S. <i>Genesis</i>	Hannibal-class
NCC-75081	U.S.S. <i>Kyushu</i>	Hannibal-class
NCC-75082	U.S.S. <i>Chekov</i>	Hannibal-class
NCC-75083	U.S.S. <i>Wasa</i>	Hannibal-class
NCC-75084	U.S.S. <i>Gage</i>	Hannibal-class
NCC-75085	U.S.S. <i>Artemis</i>	Hannibal-class
NCC-75088	U.S.S. <i>London</i>	Sovereign-class
	Vessel launched in 2373.	
NCC-75098	U.S.S. <i>Yorktown</i>	Sovereign-class
	Launched stardate 53113.1 from the Tranquility Base Yards. The ship's motto was "Victory is our tradition."	
NCC-75100	U.S.S. <i>Majestic</i>	Sovereign-class
NCC-75124	U.S.S. <i>Argus</i>	Sovereign-class
NCC-75153	U.S.S. <i>Diamond</i>	Hannibal-class
NCC-75220	U.S.S. <i>Impala</i>	Impala-class
	First vessel of her class, designated an exploratory cruiser.	
NCC-75226	U.S.S. <i>Seleya</i>	Seleya-class
	Research vessel, the first of her class. Launched in 2373, the ship was 256m long, 106m high and 88m wide with a crew of 112.	
NCC-75227	U.S.S. <i>Talon</i>	Talon-class
	Advanced scout vessel, the first of her class. Assigned to Starbase 315 in 2373.	
NCC-75234	U.S.S. <i>Pulsar</i>	Corona-class
NCC-75264	U.S.S. <i>Alouette</i>	Fabrux-class
NCC-75265	U.S.S. <i>Formosa</i>	Fabrux-class

NCC-75266	U.S.S. <i>Westerwald</i>	Fabrux-class
NCC-75267	U.S.S. <i>Sunflower</i>	Fabrux-class
NCC-75268	U.S.S. <i>Fort Worth</i>	Fabrux-class
NCC-75269	U.S.S. <i>Shalik</i>	Fabrux-class
NCC-75270	U.S.S. <i>Trekrendik</i>	Fabrux-class
NCC-75271	U.S.S. <i>Cheng</i>	Fabrux-class
NCC-75288	U.S.S. <i>Union</i>	Seleya-class
NCC-75418	U.S.S. <i>Valiant</i>	
NCC-75439	U.S.S. <i>Sparrowhawk</i>	Talon-class
NCC-75538	U.S.S. <i>Maelstrom</i>	Tsunami-class
NCC-75631	U.S.S. <i>Resolute</i>	Resolute-class
	Light cruiser, the first ship of her class. Launched from Utopia Planitia in 2373, the ship was 363m long, 146m wide and 124m high. The ships standard compliment was 304.	
NCC-75633	U.S.S. <i>São Paulo</i>	Defiant-class
	Starship renamed <i>Defiant</i> by Captain Benjamin Sisko.	
	U.S.S. <i>Defiant</i>	Defiant-class
NCC-75640	U.S.S. <i>Consul</i>	Resolute-class
NCC-75641	U.S.S. <i>Octopus</i>	Resolute-class
NCC-75660	U.S.S. <i>Meteor</i>	Meteor-class
	Starship, the first of her class, designated a frigate. Starfleet's second attempt at a multi-vector design, the ship can separate into two independent vessels. It was 348m long, 133m wide and 54m high, with a crew of 120.	
NCC-75661	U.S.S. <i>Raleigh</i>	Meteor-class
NCC-75698	U.S.S. <i>Nimrod</i>	Resolute-class
	The <i>Nimrod</i> was nearly commissioned at Utopia Planitia when a Breen forces attacked the Sol system. It arrived at Earth with the first wave of Breen fighters and eliminated three. The <i>Nimrod</i> also destroyed two large Breen cruisers and six fighters.	
NCC-75715	U.S.S. <i>Capitol</i>	Resolute-class
NCC-75810	U.S.S. <i>Albatross</i>	Meteor-class
NCC-75811	U.S.S. <i>Mustang</i>	Meteor-class
NCC-75812	U.S.S. <i>Sulu</i>	Meteor-class
NCC-75813	U.S.S. <i>Brisbane</i>	Meteor-class
NCC-75909	U.S.S. <i>Hippocrota</i>	Galaxy-class
NCC-76124	U.S.S. <i>Alabama</i>	
NCC-76220	U.S.S. <i>Steamrunner</i>	Steamrunner-class
	Starship, first of her class, designated a heavy frigate. 355m long.	

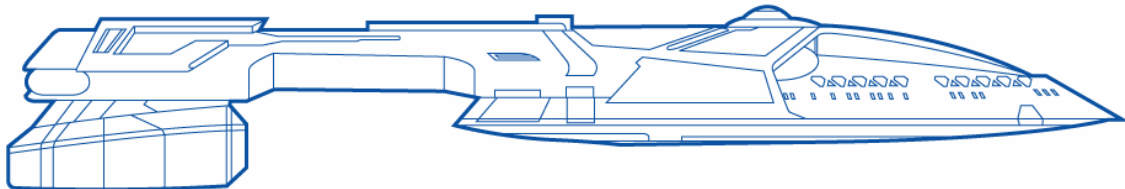

NCC-76308	U.S.S. <i>Challenger</i>	
NCC-76391	U.S.S. <i>Geller</i>	Cheyenne-class
	Destroyed.	
NCC-76414	U.S.S. <i>Renegade</i>	Sovereign-class
NCC-76495	U.S.S. <i>Surol</i>	Cheyenne-class

NCC-76531	U.S.S. <i>Resoute</i>	
NX-76639	U.S.S. <i>Aquarius</i>	Aquarius-class
	Pathfinder vessel of her class, designated a light cruiser. Launched in 2375, the ship was 424m long, 164m wide and 87m high, with a crew of 320.	
NCC-76719	U.S.S. <i>Blackthorne</i>	Intrepid-class
NCC-76788	U.S.S. <i>Avenger</i>	Copernicus-class
NCC-76812	U.S.S. <i>Sitting Bull</i>	Cheyenne-class
NCC-76991	U.S.S. <i>Cherokee</i>	Cheyenne-class
NX-77000	U.S.S. <i>Neptune</i>	Neptune-class
	Heavy cruiser, the first of her class. Launched in 2376, the ship was 533m long, 313m wide and 99m high, with a crew of 660.	
NCC-77039	U.S.S. <i>Glenn</i>	Glenn-class
	First vessel of her class, a superscout.	
NX-77103	U.S.S. <i>Molson</i>	Molson-class
	Pathfinder of her class, a light cruiser.	
NCC-77205	U.S.S. <i>Griffin</i>	Griffin-class
	Pathfinder vessel of her class, a medium cruiser with a crew of 225. It was 444.39m long, 155.44m wide and 87.78m high.	
NCC-77302	U.S.S. <i>Defiance</i>	Defiant-class
NCC-77331	U.S.S. <i>Cicorro</i>	Defiant-class
NCC-77532	U.S.S. <i>Imperial</i>	Imperial-class
	Prototype fast scout.	
NCC-77625	U.S.S. <i>Turner Joy</i>	Turner Joy-class
	First starship of her class, a dreadnought.	
NCC-77626	U.S.S. <i>Mitscher</i>	Turner Joy-class
NCC-77627	U.S.S. <i>Spruance</i>	Turner Joy-class
NCC-77628	U.S.S. <i>Slark</i>	Turner Joy-class
NCC-77629	U.S.S. <i>King</i>	Turner Joy-class
NCC-77712	U.S.S. <i>Horatio</i>	Steamrunner-class
	Launched in 2373.	
NCC-78439	U.S.S. <i>Deluge</i>	Dapper-class
NCC-78630	U.S.S. <i>Ulysses</i>	Galaxy-class
NCC-78655	U.S.S. <i>Oregon</i>	Geneva-class
NX-78773	U.S.S. <i>Federation</i>	Federation-class
	Explorer, the first ship of her class, launched in 2377. 823m long, 446m wide and 144m high, the ship's complement is 1236.	
NCC-78965	U.S.S. <i>Zephyr</i>	
NCC-79221	U.S.S. <i>Sabre</i>	Sabre-class
	First starship of her class. 172m long.	

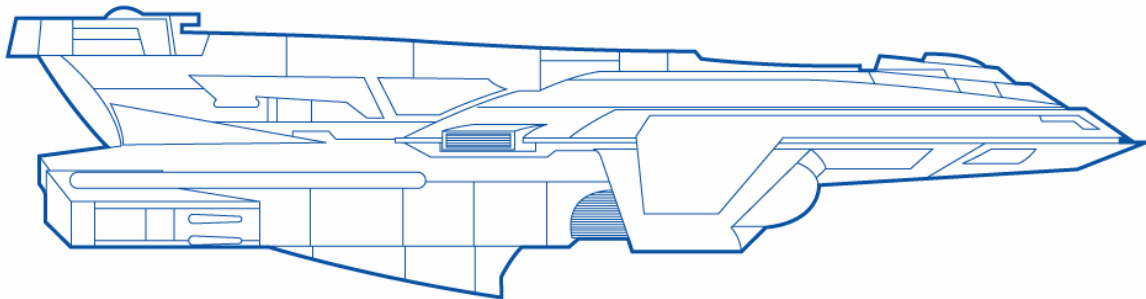

NCC-79222 U.S.S. *Mercury* Sabre-class

NCC-79223	U.S.S. <i>Pathfinder</i>	Sabre-class
NCC-79256	U.S.S. <i>Tigra</i>	Sabre-class
NCC-79299	U.S.S. <i>Nightwatch</i>	Sabre-class
NCC-79415	U.S.S. <i>Roadrunner</i>	Sabre-class
NCC-80102	U.S.S. <i>Titan</i>	Luna-class
	Starship launched stardate 56979.5 from the Utopia Planitia Fleet Yards. William Riker was assigned the ship's commanding officer. The ship's motto was " <i>Infinite Diversity in Infinite Combinations</i> "	
NCC-80551	U.S.S. <i>Damocles</i>	Sabre-class
NCC-81000	U.S.S. <i>Khai Tam</i>	Khai Tam-class
NCC-81001	U.S.S. <i>Relentless</i>	Khai Tam-class
NCC-81096	U.S.S. <i>Shadow Horseman</i>	Prevaricate-class
NCC-81277	U.S.S. <i>Majestic</i>	
NCC-81623	U.S.S. <i>da Vinci</i>	Sabre-class
	Assigned to the Starfleet Corps of Engineers.	
NCC-81947	U.S.S. <i>Yeager</i>	Yeager-class
	First vessel of her class. With a crew of 204, it was 402.11m long, 195.64m wide and 58.69m high.	
NCC-82015	U.S.S. <i>Arleigh Burke</i>	Pioneer-class
NCC-82035	U.S.S. <i>Defender</i>	Callisto-class
NCC-82455	U.S.S. <i>Arminius</i>	
NX-83501	U.S.S. <i>Tiburon</i>	Tiburon-class
	An experimental cruiser design, 428.5 m long.	
NCC-84784	U.S.S. <i>Missouri</i>	Prevaricate-class
NCC-87200	U.S.S. <i>Grand Alliance</i>	
NX-89000	U.S.S. <i>Hydra</i>	Hydra-class
	Starship, first of her class.	
NX-91172	U.S.S. <i>Steadfast</i>	Steadfast-class
	First starship of her class, a destroyer.	
NCC-91400	U.S.S. <i>Grayson</i>	Grayson-class
	The first vessel of her class, a repair tender.	
NX-95472	U.S.S. <i>Petaluma</i>	Petaluma-class
	Starship, the first of her class.	
NCC-98000	U.S.S. <i>Singh</i>	Singh-class
	Starship, first of her class. A battleship.	
NCC-293391	U.S.S. <i>Masada</i>	
	A transport/tug, commanded by Lt. Kevin Keeler.	

Acknowledgements

Fandom is a big place. That's what 40 years of material inevitable brings. But there are a few, particularly helpful websites I need to mention that graciously allowed me to include their excellent material in this body of work.

www.ex-astris-scientia.org

Bernd Schneider's excellent resource of technical material includes the EAS Fleet Yards, a section of starships designed and detailed by Bernd himself. Designed using very strict guidelines that Bernd has set out "what make a good starship design", the entire site is a resource familiar to all fans with internet access.

www.starfleet-museum.org

Masao Okazaki's website detailing the early vessels of Starfleet and the Federation, the incredible vessels here are designed are all of special historical importance to the Fleet. Again, like Bernd's site, the starships Masao has designed follow logical design rules and are also considered by most fans as the 'real' early history of the Federation.

Besides these two excellent sites, *many* other related sites were of special help when compiling this listing. And while some have drifted off into internet history, others still remain as valuable technical resources and sources of entertainment. These include, but are not limited to:

<http://www.cygnus-x1.net/links/lcars/index.html> -- Blueprint Database

<http://www.gilsostartrekschematics.org.uk> -- Gilso's Schematic database

<http://www.shipschematics.net> -- Starship Schematic Database

<http://www.captainmike.org/Galactopedia> -- Captain Mike's Galactopedia

<http://www.treknology.org/index.htm> -- The Journal of Applied Treknology

<http://topher.pleh.net/misc/mstrlst.html> -- Master Ship List

<http://www.fleetyard.net/> -- Titan Fleet Yards

http://memory-alpha.org/en/wiki/Main_Page -- Memory Alpha Wiki

<http://topher.pleh.net/sd/> -- Starfleet Design